



Upper Columbia Basin Groundwater Monitoring Program 2019 Data Collection Summary

Prepared by:

Carol Luttmmer, MSc. (Eng) BSc.

C Waters
Consulting

&

Antonio Barroso, MSc. BSc. P.Eng



GW SOLUTIONS
ASSESSMENT & PROTECTION OF GROUNDWATER

Prepared for:

Living Lakes Canada

Invermere, British Columbia

January 2020

Acknowledgements:

First and foremost, thank you to the First Nations, local governments, water utilities, organizations, and landowners who have volunteered their wells to be part of the Upper Columbia Basin Groundwater Monitoring Program. These include ʔaᑭam, City of Castlegar, City of Cranbrook/Kala Geosciences, District of Invermere, Playmor Water Utility, The Nature Trust of British Columbia, Roger Chadwick, Ron Clarke, Kat Hartwig, Duane LaFond, Randi Jensen, and Jeff Watson. Without their support, the Program would not be possible. Numerous other organizations and landowners have helped identify priority areas and potential wells to monitor. Over the last several years, field work and data collection were conducted by Living Lakes Canada staff, contractors, well owners, and volunteers. Although there are too many to name here, their efforts and contributions have not gone unnoticed.

The Ministry of Forests, Lands & Natural Resources Operations and Rural Development has provided ongoing support including advice on priority aquifers and the suitability of wells for long-term monitoring. The Environmental and Climate Monitoring Section of the Ministry of Environment and Climate Change Strategy have also provided on-going support and are hosting data on the BC Real-time Water Data Website. The preliminary hydraulic connectivity assessments described on the Well Information Sheets were conducted by Ian Wallace and reviewed by Paul Bauman in 2017. Greg Utzig, Janice Brahney, and Martin Carver delineated the Upper Columbia Basin into hydrologic regions based on similar patterns of hydrology and climate, which forms the base map for Figure 1 in this report.

We are grateful to Richard Johnson for mapping support and to Randy Shinduke (Advisian) and Martech Electrical Systems Inc. who provided technical support in the field in 2019. GW Solutions prepared the well construction logs and the Tableau database for managing the data. GW Solutions also provided ongoing advice on Program development and assisted with mapping components of the Program. Carol Luttmmer (C Waters Consulting) and Antonio Barroso (GW Solutions) compiled and analyzed the data and produced this report.

In particular we are grateful to Gilles Wendling for his unwavering support of the Program and to Living Lakes Canada. We thank Jillian Kelly, John Pogson, Lindsay Berry, Paul Bauman, and Richard Johnson for their constructive comments during reviews of drafts of this report.

Funding and in-kind contributions for this Project were provided by:



About Living Lakes Canada:

Living Lakes Canada works to enhance the protection, restoration, rehabilitation, and health of watersheds in British Columbia and across Canada. We build capacity through community-based water monitoring to help address climate impacts. We promote and facilitate cross-sector collaboration and research to increase water literacy and support progressive decision-making for improved water stewardship. Our successful leadership and stewardship templates have supported the creation of many other grassroots water stewardship groups.

Living Lakes Canada has received multiple water stewardship awards and has been recognized by the federal government as a “best practices” example in community-based ecological monitoring in Canada. Living Lakes Canada is the recipient of two 2017 Water’s Next Awards (Water Steward of the Year and Non-Government Organization Winner) and was featured in the March/April 2019 issue of Water Canada magazine for work as one of Canada’s top water stewards.

Living Lakes Canada is a registered charity and affiliated with German-based Global Nature Fund’s Living Lakes International, a global network of organizations that share the same mission: to enhance, protect, restore and rehabilitate freshwater areas around the globe.

Data Availability:

The Volunteer Observation Well (VOW) data are available on the [BC Real-time Water Data Website](#)¹ for wells where the well owner has signed a data sharing agreement with Living Lakes Canada. The format for the site identifier for Living Lakes Canada Volunteer Observation Wells on the BC Real-time Water Data Website is LLC-VOW-##. Outliers and pumping effects have been removed from the data posted on the BC Real-time Water Data Website.

Suggested Citation:

Luttmer, C. and A. Barroso, 2020. Upper Columbia Basin Groundwater Monitoring Program – 2019 Data Collection Summary. Prepared for Living Lakes Canada. January 2020.

If you are interested in participating in the Upper Columbia Basin Groundwater Monitoring Program, please contact Living Lakes Canada at groundwater@livinglakescanada.ca.

¹ <https://www2.gov.bc.ca/gov/content/environment/air-land-water/water/water-science-data/water-data-tools/real-time-water-data-reporting>

Executive Summary

Living Lakes Canada's Upper Columbia Basin Groundwater Monitoring Program evolved from a pilot project in 2013 that engaged local citizens in the collection of groundwater data. The Program is collecting groundwater level data to increase knowledge about groundwater resources in the Basin and inform groundwater protection and management in order to meet human and ecological needs under changing climate conditions. The purpose of this report is to summarize the data collected to date. It provides information on the wells being monitored, methods, and preliminary data interpretation to support use of the data by third parties.

The objectives of Living Lakes Canada's Upper Columbia Basin Groundwater Monitoring Program are to:

- (1) collect groundwater level data to determine how levels change seasonally and from year to year;
- (2) engage partners and citizens in the collection of data to increase knowledge and awareness about groundwater; and
- (3) share data publicly so they can be used by researchers, water managers, water licensing officers, policy makers, and citizens, to protect and manage the resource.

The Program identifies existing wells that can be used for long-term monitoring of groundwater levels. It partners with well owners (such as First Nation, local, regional, and provincial governments, water purveyors, and private landowners) to install equipment and monitor groundwater levels using water level sensors and data loggers. Data from the Program are stored and analyzed in a Tableau® database managed by Living Lakes Canada and its technical advisors. Water level data are compared to precipitation from nearby meteorological stations and to water levels from nearby hydrometric stations to assist with data interpretation. Temporal trends can be assessed in the future, once several years of data have been collected. The groundwater level data are shared publicly on the BC Real-time Water Data Website for monitoring sites where there is a data sharing agreement in place between the well owner and Living Lakes Canada.

To date, the Program has established 14 Volunteer Observation Wells in the Upper Columbia Basin. Monitoring is on-going in 13 wells and data are available for 11 of these wells on the BC Real-time Water Data Website. Additional wells have been identified for inclusion in the Program, and plans are underway to add these wells to the Program. Preliminary water level assessments indicate that the Volunteer Observation Wells are monitoring a variety of groundwater systems in the Upper Columbia Basin including those dominated by surface water-groundwater interactions, mountain block recharge, and precipitation infiltration recharge.

Table of Contents

1	Introduction	1
1.1	Overview of the Upper Columbia Basin Groundwater Monitoring Program	1
1.1.1	Program Objectives	2
1.1.2	Program Rationale.....	2
1.1.3	How the Program Works	3
1.2	Report Purpose	5
2	Methods	5
2.1	Summary of Well and Aquifer Information	5
2.2	Water Level Monitoring	5
2.3	Data Management, Review & Analyses	6
2.4	Preliminary Water Level Assessment.....	7
2.5	Data Uploads to BC Real-time Water Data Website	7
3	Results	8
4	Conclusions and Recommendations.....	13
5	Report Closure	14

List of Figures

Figure 1: Overview of the Upper Columbia Basin. 1

Figure 2: Living Lakes Canada Volunteer Observation Wells (VOW) and Provincial Groundwater Observation Well Network Wells (OW) in the Upper Columbia Basin. 9

List of Tables

Table 1: Key areas and priority aquifers for monitoring in the Kootenay/Columbia sub region recommended in the 2009 Provincial Groundwater Observation Well Network Review. 3

Table 2: Key areas and priority aquifers for monitoring recommended to Living Lakes Canada by the Ministry of Forests, Lands, and Natural Resources Operations and Rural Development in 2017. 3

Table 3: Summary of Volunteer Observation Wells in the Upper Columbia Basin. 10

Table 4: Preliminary Water Level Assessment for Volunteer Observation Wells in the Upper Columbia Basin 11

List of Appendices

Appendix A: Description of information included on the Well Information Sheets.....A-1

Appendix B: Well location maps, well information sheets, well construction logs, and interpretative graphs for Volunteer Observation Wells B-1

1 Introduction

1.1 Overview of the Upper Columbia Basin Groundwater Monitoring Program

Living Lakes Canada’s Upper Columbia Basin Groundwater Monitoring Program is collecting and sharing groundwater level data from wells in the Upper Columbia River Basin. The Basin is located in southeastern British Columbia and comprises of the Canadian portion of the Columbia River Watershed that is upstream of Montrose (Figure 1). The goal of the Program is to increase knowledge about groundwater resources in the Basin so they can be protected and managed to meet human and ecological needs under changing climate conditions.

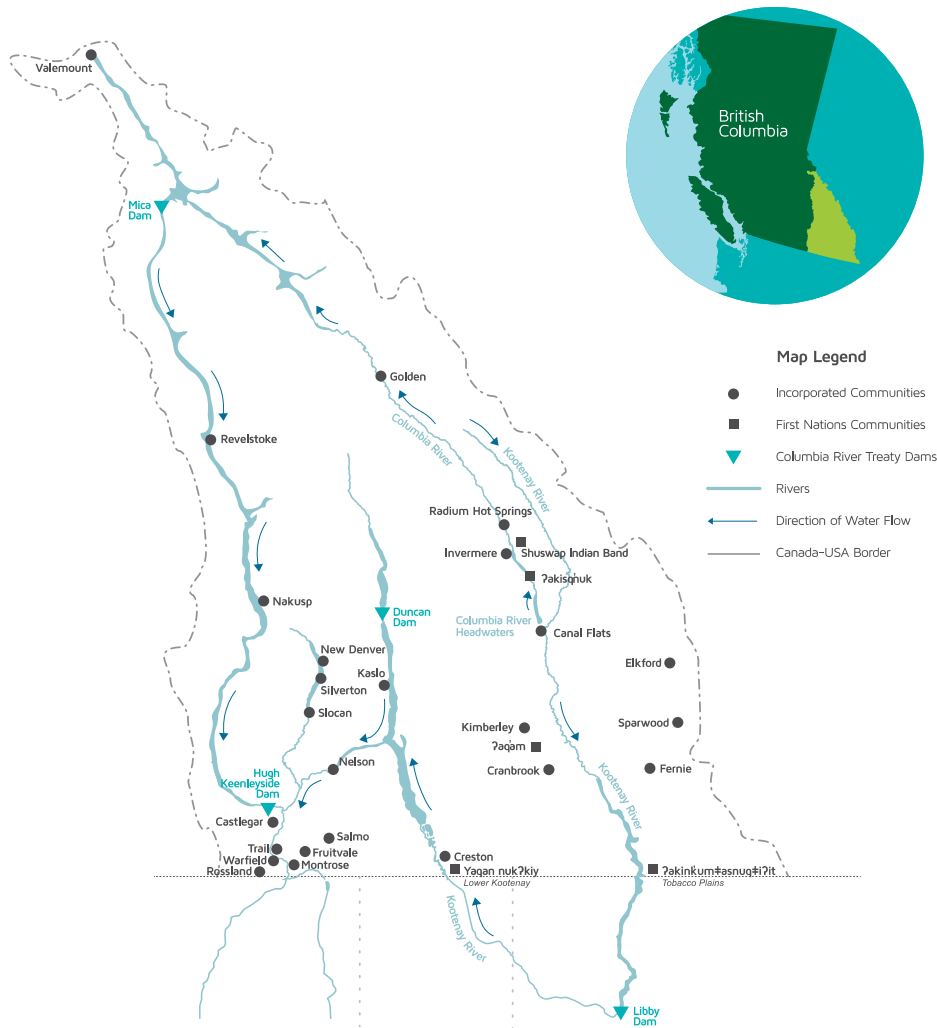

Figure 1: Overview of the Upper Columbia Basin.²

² Columbia Basin Trust Map. Retrieved from: https://ourtrust.org/wp-content/uploads/downloads/2016-11_Trust_RegionMap_FINAL-1.pdf

1.1.1 Program Objectives

The objectives of the Upper Columbia Basin Groundwater Monitoring Program are to:

- (1) collect groundwater level data to determine how levels change seasonally and from year to year;
- (2) engage partners and citizens in the collection of data to increase knowledge and awareness about groundwater; and
- (3) share data publicly so they can be used by researchers, water managers, policy makers, groundwater licensing officers, consultants, and citizens to protect and manage the resource.

1.1.2 Program Rationale

The impetus for the Program is the lack of site-specific groundwater data in the Upper Columbia Basin to effectively inform groundwater protection and management, and adaptation to climate change. The provincial government aquifer mapping program has mapped 184 aquifers to date in the Upper Columbia Basin in areas where there is a history of human use³. Groundwater levels are monitored in six of these aquifers as part of the Provincial Groundwater Observation Well Network (PGOWN)⁴.

The needs to increase groundwater monitoring and analyses were highlighted in a 2017 comprehensive review of water monitoring and climate change in the Upper Columbia Basin⁵. Pressures on groundwater are likely to intensify as demand increases, climate change intensifies, and surface waters become seasonally restricted and/or of inadequate quality, reducing their viability as a water source. In 1999, an Auditor General report on protecting drinking water recommended that groundwater levels should be monitored in all developed aquifers across the Province⁶. The Auditor General report and a 2009 review of the PGOWN⁷ both suggested that partnerships involving communities, water users, and other stakeholders are needed to monitor groundwater to provide sufficient data for effective management. Living Lakes Canada's Upper Columbia Basin Groundwater Monitoring Program is facilitating those partnerships to collect, manage, and share groundwater data from existing wells in the Upper Columbia Basin.

³<https://www2.gov.bc.ca/gov/content/environment/air-land-water/water/groundwater-wells-aquifers/understanding-aquifers>

⁴<https://www2.gov.bc.ca/gov/content/environment/air-land-water/water/groundwater-wells-aquifers/groundwater-observation-well-network>

⁵ Carver, M. 2017. Water Monitoring and Climate Change in the Upper Columbia Basin Summary of Current Status and Opportunities. Report prepared for the Columbia Basin Trust. January 2017. Retrieved from: https://ourtrust.org/wp-content/uploads/downloads/WaterMonitoringandClimateChange_FullReport_2017_FINAL_Web-5.pdf

⁶ Office of Auditor General of British Columbia. 1999. Protecting Drinking Water Sources - Auditor General Report. October 1999. Retrieved from: <https://www.bcauditor.com/sites/default/files/publications/1999/report5/report/protecting-drinking-water-sources.pdf>

⁷ Hy-Geo Consulting, Hodge Hydrogeology Consulting, and Azar & Associates. 2009. Provincial Observation Well Network Review British Columbia. Prepared for Water Stewardship Division BC Ministry of Environment. Retrieved from: http://a100.gov.bc.ca/appsdata/acad/documents/r20489/ObsWellNetworkReviewVol1_1292876648183_8691bd33a0340692500d37fb4a445e7ed50dda2e2a5107fdc65fb54918231a94.pdf

1.1.3 How the Program Works

The Program identifies priority areas and suitable wells for monitoring in partnership with community groups, landowners, researchers, consultants, well drillers, First Nations, municipalities, and regional and provincial governments. The 2009 PGOWN review recommended priority aquifers for monitoring by region (Table 1). In 2017, the Ministry of Forests, Lands, and Natural Operations and Rural Development (FLNRORD) provided an updated list of priority aquifers for monitoring to Living Lakes Canada (LLC) and LLC initially focused on finding wells to monitor in those aquifers (Table 2). Community groups, landowners, and local and regional governments have also provided information to Living Lakes Canada on priority monitoring areas and the Program is following up on those recommendations.

Table 1: Key areas and priority aquifers for monitoring in the Kootenay/Columbia sub region recommended in the 2009 Provincial Groundwater Observation Well Network Review.⁸

Key Area	Aquifer Number (Unconsolidated Aquifers)	Aquifer Number (Bedrock Aquifers)
Cranbrook-Kimberley	524,525, 538, and 540	523, 535, 535, and 537
Golden	456	
Wardner-Jaffrey	521 and 528	529
Castlegar	505, 507, and 508	
Kootenay Lake	516	
Invermere- Windermere	603	
Creston	487	488
Slocan	514	511

Table 2: Key areas and priority aquifers for monitoring recommended to Living Lakes Canada by the Ministry of Forests, Lands, and Natural Resources Operations and Rural Development in 2017.

Key Area	Aquifer Number
Cranbrook - Kimberley	524, 525, 538
Wardner – Jaffray	528
Golden	456
Castlegar	505, 508
Kootenay Lake	516
Blewett	511
Invermere - Windermere	603
Creston	487
Slocan	514

⁸ Adapted from Table 35 in Hy-Geo Consulting, Hodge Hydrogeology Consulting, and Azar & Associates. 2009. Provincial Observation Well Network Review British Columbia. Prepared for Water Stewardship Division BC Ministry of Environment. Retrieved from: http://a100.gov.bc.ca/appsdata/acat/documents/r20489/ObsWellNetworkReviewVol1_1292876648183_8691bd33a0340692500d37fb4a445e7ed50dda2e2a5107fdc65fb54918231a94.pdf

Wells to be used for monitoring are identified by searching on-line provincial databases (i.e. the provincial government's online data repository for well and aquifer information, [GWELLS](#))⁹; contacting provincial government ministries, First Nations, local and regional governments, stewardship groups, well drillers, consultants, and local residents; through outreach events such as conferences, workshops and presentations to town councils; and requests on social media. Wells are initially assessed to determine their suitability for monitoring based on the following screening criteria:

- not duplicate monitoring efforts of the Provincial Groundwater Observation Well Network (PGOWN);
- feasibility of incorporating the well into the PGOWN in the future;
- meets the construction standards of the BC Groundwater Protection Regulation (e.g. well casing sticks up a sufficient amount above the ground, and adequate surface seal is present);
- the lithology and well completion details are known;
- is easily accessible;
- can likely be sustainable for long term monitoring (> 10 years);
- well owner is willing to sign an agreement for site access and to share data publicly;
- can provide information on ambient aquifer conditions (e.g. it is not influenced by pumping of nearby wells); and
- the groundwater level data will increase understanding of groundwater resources in the Basin and/or increase awareness about groundwater.

If a well is assessed to be suitable, the Program staff work with the well owner to establish the well as a Volunteer Observation Well (VOW). This includes signing a site access and data sharing agreement and selecting and installing water level sensors and data loggers. Often, several years of data are required to assess if the well is appropriate for long-term monitoring and to determine the factors influencing the water level response.

While searching for suitable wells to monitor, it was discovered that many of the wells in Upper Columbia Basin drilled in sand and gravel aquifers did not have well screens installed, and some are missing lithology and well construction details. Some of these wells were initially included in the Program despite the lack of construction information and/or well screens to begin developing protocols for the Program and test their suitability for long-term monitoring despite not having screens installed.

To facilitate the management of large data sets (i.e. hourly groundwater level and temperature information) data from the Program are stored and analyzed in a Tableau® database managed by Living Lakes Canada. Data cleaning (i.e. removing pumping effects, outliers, correcting for instrument drift) and preliminary data interpretation (i.e. water level data compared to precipitation and hydrometric monitoring data, trend analysis, monthly, seasonal yearly variation of groundwater levels) are completed within the Tableau® data frame. The groundwater level data are shared publicly on British Columbia's Provincial Government's [Real-time Water Data Website](#)¹⁰ for monitoring sites where the well owner has signed a data sharing agreement with Living Lakes Canada.

⁹ <https://apps.nrs.gov.bc.ca/gwells/>

¹⁰ <https://www2.gov.bc.ca/gov/content/environment/air-land-water/water/water-science-data/water-data-tools/real-time-water-data-reporting>

1.2 Report Purpose

The purpose of this report is to summarize the data collected to date in the Upper Columbia Basin Groundwater Monitoring Program. It provides information on the wells and aquifers being monitored, methods, and results to support use of the Program's water level data that are available on the [BC Real-time Water Data Website](#). Graphical representations of the data are also presented and compared to precipitation and stream flow data to facilitate interpretation of groundwater level data. A preliminary water level assessment was conducted to identify the types of groundwater systems being monitored by the Volunteer Observation Wells.

2 Methods

2.1 Summary of Well and Aquifer Information

Well and aquifer information were compiled from well construction records provided by well owners, provincial aquifer mapping reports, aquifer factsheets, and information from the [GWELLS](#) database. Additional information was compiled from site visits by LLC staff, contractors, and volunteers, and site-specific reports provided by the well owners and program partners. Well construction details (e.g. well depth) are typically reported in imperial units, even for wells drilled recently. All imperial units have been converted to metric for this report.

Appendix A describes the well and aquifer information that have been compiled for each Volunteer Observation Well. Preliminary high-level assessments of hydraulic connectivity between the aquifers being monitored and surface waters were conducted by LLC's advisors based on information from iMapBC, GWELLS, and Google Earth. The well and aquifer information are presented in *Monitoring Well Information Sheets* in Appendix B. Appendix B also includes location maps and well construction logs for each Volunteer Observation Well.

2.2 Water Level Monitoring

Water level, water temperature, and barometric pressure measurements are being collected using water level sensors and data loggers. The majority of the Volunteer Observation Wells are using or HOBOMX 2001 Bluetooth or HOBOU20 Water Level Loggers. Some sites have different water level sensors and data loggers based on the requirements of the well, the availability of equipment, and the needs of the well owner. The monitoring equipment at each well is listed in *Well Information Sheets* (Appendix B). For most sites, measurements are being collected hourly, consistent with the Provincial Groundwater Observation Well Network.

Data from the HOBOU20 Loggers are downloaded using HOBOWaterproof Shuttle whereas data from the HOBOMX 2001 loggers are downloaded via Bluetooth using Onset's HOBOMobile App. Water levels are determined by collecting the absolute pressure of the water column above the sensor, compensating it for atmospheric pressure, and calibrating it with manual water level measurements using either the HOBOWare Pro software or the HOBOMobile App. For the conversion of pressure to water level the water density of freshwater is adjusted for water temperature. The barometric pressure is typically measured by a barometer in the airspace at the top of the well as described on the *Well Information Sheets*.

Reference water levels (manual measurements) are collected using water level meters (i.e. Solinst Water Level tapes) and are measured from a marked point at the top of the well casing. Typically, the water level is calibrated based on a reference manual water level measurement at the beginning of a monitoring period. At each site visit the manual water level is compared to the data logger output, and the reference water level is updated if the manual and water logger data differ more than +/-0.01m.

Sites visits are conducted by Living Lakes Canada staff, contractors, and/or the well owners or volunteers following protocols outlined in the Upper Columbia Basin Groundwater Monitoring Program Field Manual. Data are recorded using a standardized monitoring form. Typically, data are downloaded and manual water level measurements are collected at each site four times per year (in the spring, summer, winter, and fall) to ensure equipment is working properly and to upload data to the BC Real-time Water Data Website in a timely manner.

2.3 Data Management, Review & Analyses

Data are imported into Living Lakes Canada's Tableau® database for review, display, analyses, and interpretation by Living Lakes Canada and its technical advisors. Water levels are converted from meters below top of casing (mTOC) to meters below ground surface (mbgs) using the stick-up (the distance from the ground surface to the top of the well casing) in the *Well Information Sheets* (Appendix A). Data have not been reported in meters above sea level as legal surveys of the wells have not been conducted.

Data are reviewed to ensure the water levels are within the operating range of the water level sensors. The quality of data is assessed by comparing the logger data with manual water level measurements. Outliers and pumping effects are identified and excluded from the data sets that are used for analyses. The resulting data are then uploaded to the Real-time Water Data Website.

Appendix B presents the following graphs for each well where sufficient data have been collected to date:

Water Level and Water Temperature: *Time series of the groundwater level and groundwater temperature data collected to date.* The data are sorted by measurement type, showing both the sensor and manual groundwater level measurements. These graphs also show outliers and pumping effects that have been removed from the data sets used in subsequent analyses. For the majority of the sites, the water level/temperature sensor is not at the same depth as the well screen, or there is no screen in the well, and therefore the water temperature may be representative of the water temperature in the well casing rather than the aquifer.

Water Level and Daily Total Precipitation: *Time series of the cleaned groundwater level data set and daily total precipitation from nearby Environment and Climate Change Canada Climate Stations¹¹.* Climate stations were selected based on proximity to the well and completeness of the precipitation record. For instance, only stations which had less than 20 days of data missing per year were considered.

Water Level & Cumulative Precipitation Departure from Average (CPD): *Time series of the cleaned groundwater level data sets, cumulative precipitation departure from average (CPD), and monthly total precipitation from nearby climate stations.* The cumulative precipitation departure from average (CPD) is a

¹¹ https://climate.weather.gc.ca/historical_data/search_historic_data_e.html

derivative of precipitation data¹². For this Program, CPD is calculated by determining the mean monthly precipitation over the groundwater level monitoring period and summing the cumulative difference between the actual monthly precipitation and the mean monthly precipitation for each month in the monitoring period. The CPD mathematically returns to zero for the last month of the monitoring period. If the CPD is negative, it is often termed a cumulative precipitation deficit. The CPD is sometimes used to evaluate the temporal correlation of precipitation with surface water or groundwater levels. However, CPD may not be the most suitable analyses methods for evaluating the temporal correlation of rainfall with groundwater levels because of several factors including the fact that precipitation is not typically normally distributed, the choice of beginning and end points of the data can affect the results, the lack of consideration that above-average rainfall can reset the hydrologic system without mathematically eliminating the accumulated deficit, and the lack of support for the necessary inference that rainfall events and hydrologic levels widely separated in time are linked¹³. Use of the CPD presented in this report should consider these factors and be used in conjunction with other analyses, such as site-specific detailed water budget analysis.

Historical Daily Flow Data and Water Level: *Average monthly and daily surface water levels from nearby hydrometric stations and average monthly and daily groundwater levels based on the cleaned data sets.* The data included in the monthly and daily averages for the flow and groundwater level are shown in the time series. Historical daily and monthly stream flow (surface water level) data were compiled from nearby hydrometric stations stored in the [HYDAT database](#)¹⁴, the National Water Data Archive for Water Survey of Canada Hydrometric Stations.

Water Level Yearly Comparison: *Groundwater level data of the cleaned data sets plotted by year.*

2.4 Preliminary Water Level Assessment

The preliminary water level assessment is based on well construction and aquifer information (summarized in Appendix B on the *Well Information Sheets*), water level data collected to date, and comparisons of the groundwater levels to precipitation, stream flow, and the Cumulative Precipitation Departure from Average (CPD) curves.

2.5 Data Uploads to BC Real-time Water Data Website

For Volunteer Observation Wells where the well owner has signed a data sharing agreement, the cleaned data sets are uploaded to BC Real-time Water Data Website after each site visit, typically four times throughout the year in the early spring, fall, winter, and summer. The Water Level and Water Temperature graphs in Appendix B identify the outliers and pumping effects that are removed to form the data sets available on the BC Real-time Water Data Website.

¹² Weber, K., and M. Stewart, 2004. A Critical Analysis of the Cumulative Rainfall Departure Concept. *Ground Water* Vol. 42, No. 6, 953-938.

¹³ Ibid.

¹⁴ <https://www.canada.ca/en/environment-climate-change/services/water-overview/quantity/monitoring/survey/data-products-services/national-archive-hydat.html>

3 Results

Fourteen wells have been incorporated into Living Lakes Canada's Groundwater Monitoring Program to date (Figure 2). Graphs are presented in Appendix B for sites where sufficient data have been collected to date. On-going monitoring is occurring in 13 wells and data for 11 wells are available on the [BC Real-time Water Data Website](#) (Table 3). Several of the Volunteer Observation Well have data gaps associated with sourcing and securing monitoring equipment during the initial phases of the Program. However, most of the wells now have continuous data sets.

Data from most of the wells are suitable for long-term monitoring and assessing seasonal and annual and groundwater level trends. However, it should be noted that several of the wells are missing construction and/or lithology information and were constructed without screens even though they are in sand and gravel aquifers (see *Well Information Sheets* in Appendix B for which wells have screens). In some of the wells, groundwater levels are influenced by groundwater pumping, either of the Volunteer Observation Well itself, or nearby wells. If the data can be sorted to exclude these effects, the Volunteer Observation Well remains in the Program. Volunteer Observation Well (VOW) 08 in Cranbrook is no longer being included in the Program. In 2018, the Provincial Groundwater Observation Well Network (PGOWN) installed a monitoring well in the same aquifer as VOW-08 in another location.

The interpretive graphs for each Volunteer Observation Well are presented in Appendix B and the preliminary groundwater level assessments are presented in Table 4. It should be noted that for several of the wells comparisons were made to precipitation data from climate stations that are at different elevations and/or in different hydrologic regions than the aquifer being monitored. Similarly, the closest hydrometric stations are not always located in the same sub-watersheds as the aquifers being monitored and may not be representative of the surface water bodies that could be influencing the aquifer. It should also be noted that much of the hydrometric data are historic and were not collected at the same time as the groundwater level data. Therefore, the graphs presented in this report should be interpreted with caution. For example, for VOW_07 in Cranbrook the closest hydrometric station is on the Kootenay River near Fort Steele, which represents flow from a large watershed, whereas the aquifer that VOW_07 is monitoring is likely influenced by the much smaller Joseph Creek tributary stream. The interpretive graphs and preliminary water level assessments are presented here as a first step to understanding the response of groundwater level to precipitation events, connection to surface water bodies, and recharge regimes in different aquifer systems in the Upper Columbia Basin.

The Volunteer Observation Wells in the Program to date represent a variety of groundwater systems found in the Upper Columbia Basin, including those dominated by surface water-groundwater interactions, mountain recharge, and precipitation infiltration recharge. Further research, additional groundwater level data, and data on other parameters (e.g. climate, water withdrawals, land cover) are needed to determine the factors affecting groundwater level response.

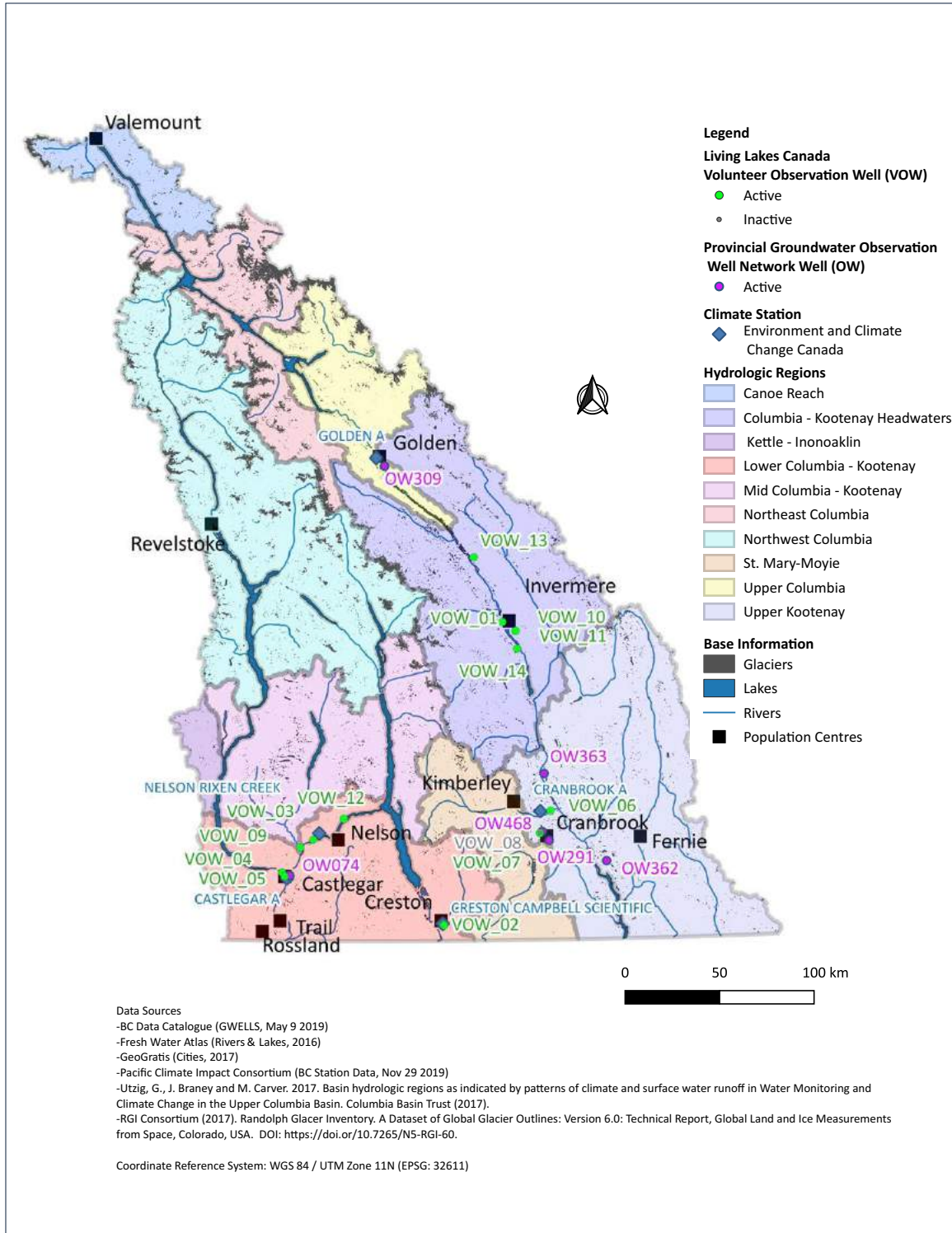

Figure 2: Living Lakes Canada Volunteer Observation Wells (VOW) and Provincial Groundwater Observation Well Network Wells (OW) in the Upper Columbia Basin.

Table 3: Summary of Volunteer Observation Wells in the Upper Columbia Basin.

Station ID	Location Description	Well Tag Number	Aquifer Number	Data available on BC Real-time Water Data Website	Status of Monitoring	Length of Monitoring Record
VOW_01	District of Invermere; near wastewater treatment plant.	None	603	Yes	Active	2013-10-12 to Current
VOW_02	Creston, S Goat River Road.	106697	487 (need to confirm)	Yes	Active	2017-02-03 to Current
VOW_03	Blewett, Carlson Road East.	87879	511	Yes	Active	2016-12-09 to Current
VOW_04	Castlegar, Near 13th Ave & Columbia Ave.	23702	505	Yes	Active	2016-11-29 to Current
VOW_05	Southeast of Castlegar, downstream of Kootenay and Columbia River confluence.	None	508	No	Active	2017-03-02 to Current
VOW_06	ᑭᐱᑭᐱ, North side of St.Mary River.	None	538	Data are held by ᑭᐱᑭᐱ	Active	2017-02-28 to Current
VOW_07	Cranbrook, Laurier St. W.	None	524	Yes	Active	2008-07-24 to 2017-05-24; 2020-02-14 to Current
VOW_08	Cranbrook, Laurier St. W.	None	525	No	Inactive	2008-07-24 to 2017-05-24
VOW_09	Playmor Junction, Playmor Road.	32162	514	Yes	Active	2019-09-10 to Current
VOW_10	Windermere, Windermere Loop Road.	66814	453	Yes	Active	2018-10-24 to Current
VOW_11	Windermere, Windermere Loop Road.	None	453	Yes	Active	2018-10-24 to Current
VOW_12	Willow Point, Heddle Road. North shore of the West Arm of Kootenay Lake.	107254	517 (need to confirm)	Yes	Active	2019-08-22 to Current
VOW_13	Brisco, Sylvania Road. East side of Columbia Wetlands.	101596	1039	Yes	Active	2019-09-17 to Current
VOW_14	North of Fairmont, Westside Road.	103641	n/a	Yes	Active	2020-01-06 to Current

Table 4: Preliminary Water Level Assessment for Volunteer Observation Wells in the Upper Columbia Basin

Station ID	Preliminary Water Level Assessment	Assessment Summary
VOW_01	<p>The yearly average groundwater fluctuation is approximately 1.5 meters. Maximum water level in June-July coincides with the high surface water level suggesting the water level is likely influenced by surface water systems. Additionally, water level follows the precipitation events (CPD curve) suggesting a strong dependency to build-up in precipitation. For instance, increasing groundwater level from October 2013 to April 2017 corresponds to an increase in precipitation during that period (CPD curve shows an upwards trend).</p>	<p>Primarily influenced by surface water-groundwater interactions.</p>
VOW_02	<p>The yearly average groundwater fluctuation is approximately 1.6 meters. Groundwater level follows the stream level change for hydrometric stations located at higher elevations. However, there is a month delay to surface water levels (i.e. Kootenay River) for hydrometric stations located at similar elevation. Maximum groundwater levels (which are typically occurring in May) are likely associated with spring freshet events. Ground levels are strongly dependant on precipitation events at higher elevations (CPD curve).</p>	<p>Mountain recharge system where water level follows a delayed freshet regime.</p>
VOW_03	<p>The yearly average groundwater fluctuation is approximately 5.1 meters. This large fluctuation is typical of deep groundwater bedrock systems. Maximum groundwater level (typically occurring in April) correlates strongly with freshet events. Minimum groundwater level coincides with end of summer, when precipitation is the lowest. The groundwater level does not follow the nearby Kootenay River level suggesting a mountain recharge system where the recharge area might be located further upgradient from the well. The groundwater recharge in this system might occur through fractures and faults. In addition, there is strong correlation to precipitation events both in frequency and magnitude (CPD curve).</p>	<p>Strong mountain recharge system.</p>
VOW_04	<p>The yearly average groundwater fluctuation is approximately 1.5 meters. Two high groundwater level events occur annually. The first high water level occurs in January-February coinciding with the build-up of precipitation events during winter months. The second high groundwater level event occurs in August-September, which is likely related to a delayed response (i.e. over months, years) of freshet events. Although the groundwater level is dependent on precipitation, its response is delayed through different recharge system mechanisms, yet to be determined.</p>	<p>Influenced by surface water-groundwater interaction in addition to a response to infiltration from precipitation.</p>

Station ID	Preliminary Water Level Assessment	Assessment Summary
VOW_05	<p>The yearly average groundwater fluctuation is approximately 4.5 meters. The fluctuation and variation of groundwater level matches the magnitude and frequency of surface water level in the nearby surface waterbody (i.e. Columbia River) suggesting a strong connection to surface water at this depth and location. Maximum groundwater level occurs in May-June, coinciding with spring freshet events, and minimum level occurs in October, coinciding with the period of lowest precipitation build up (end of summer).</p>	<p>Strongly connected to surface waterbodies. Spring freshet recharge system.</p>
VOW_06	<p>The yearly average groundwater fluctuation is approximately 2.0 meters. Groundwater level is strongly correlated to surface water level (i.e. St. Mary River). Additionally, other changes in groundwater level might be due to nearby groundwater pumping. The main recharge systems for this well/aquifer is a combination of surface water and direct infiltration from precipitation. However, the response to precipitation might be delayed. The high groundwater level occurs in May-June (coinciding with spring freshet events) and low level occurs in November to January.</p>	<p>Strongly connected to surface waterbodies. Delayed spring freshet recharge system.</p>
VOW_07	<p>The yearly average groundwater fluctuation is minimum and estimated at approximately 0.5 meters, suggesting a small recharge. However, in the ten years of data (2008-2017) groundwater has fluctuated 2 meters, correlating to precipitation events (CPD curve). There are no hydrometric stations in close proximity. The hydraulic connectivity assessment indicates the aquifer may be partially recharged through local tributary streams (i.e. Joseph Creek) because of the proximity of the unconfined aquifer to the surface.</p>	<p>Precipitation infiltration recharge system (delayed spring freshet regime) and may be connected to surface waterbodies.</p>
VOW_08	<p>The yearly average groundwater fluctuation is approximately 0.2 meters (from 2008 to 2012). The water level is greatly influenced by water withdrawals and/or pumping tests (more so after 2013). The groundwater level is precipitation driven as shown by the increasing groundwater level trend from 2008 to 2017 coinciding with the increasing build up in precipitation during that period (CPD curve). There is no direct connection to surface water streams (i.e. Joseph Creek) and the aquifer may be connected to the overlying aquifer. Based on the groundwater level, the recharge system is a mountain regime with high water level happening in July (delayed response to freshet) and minimum water level occurring in November (delayed response to low precipitation events).</p>	<p>Mainly precipitation infiltration recharge system (delayed spring freshet regime).</p>
VOW_09	<p>Limited information. Based on the well construction report, the level in the aquifer might respond to a delayed freshet system.</p>	<p>Need longer data set to assess (Began monitoring in September 2019).</p>

Station ID	Preliminary Water Level Assessment	Assessment Summary
VOW_10	The yearly average groundwater fluctuation is approximately 0.7 meters based on the one year of data collected to date. The high level occurred in October and minimum in May-June. No connection to surface water is identified. The groundwater level mainly follows the build-up in precipitation events (CPD curve). The groundwater level increases during months of increased precipitation and decreases in months with less precipitation.	Mainly precipitation infiltration recharge system (spring freshet regime).
VOW_11	The yearly average groundwater fluctuation is approximately 0.7 meters based on the one year of data collected to date. The high level occurred in October and minimum in May-June. No connection to surface water is identified. The level mainly follows the build-up in precipitation events (CPD curve). The groundwater level increases during months of increased precipitation and decreases in months with less precipitation.	Mainly precipitation infiltration recharge system (spring freshet regime)
VOW_12	Limited information. Based on well construction and local topography, the groundwater level in this deep system might respond to a delayed freshet regime.	Need longer data set to assess (Began monitoring in August 2019).
VOW_13	Limited information. However, the shallow water level and the well construction details suggest an upward flow associated with a mountain recharge system may be occurring at this location.	Need longer data set to assess (Began monitoring in September 2019).
VOW_14	Limited information. Well located on the west benches of the Columbia Wetlands.	Need longer data set to assess (Began monitoring in January 2020).

4 Conclusions and Recommendations

The goal of the Upper Columbia Basin Groundwater Monitoring Program is to provide long-term groundwater level data that will help manage and protect groundwater resources in the Basin for ecological and human needs. The Program is successfully collecting and sharing groundwater level data by partnering with well owners and establishing Volunteer Observation Wells. This report provides information on the Volunteer Observation Wells, interpretive graphs on the data collected to date, and preliminary water level assessments to support use of the groundwater level data from this Program that are available publicly on the [BC Real-time Water Data Website](#).

The data collected in the Program can support a variety of regulatory, planning, and research needs to effectively manage and protect groundwater resources. For example, data may be used in groundwater supply investigations, aquifer mapping, aquifer water budgets and assessments, source water protection planning, identifying groundwater recharge areas, studying groundwater-surface water interactions, and monitoring and managing the impacts of land-use, water withdrawals, and climate change on groundwater resources. For many of these purposes, data on other parameters such as climate, surface water flows, water withdrawals, and landcover are also needed. The Program should support an integrated approach for collection of data across the Basin.

Additional information on the Volunteer Observation Wells would help maximize use of the data collected. For example, surveys of well elevations would support local groundwater flow modelling and water quality

data would assist further interpretation and characterization of the site-specific groundwater regimes. Water quality data can be used to corroborate recharge regimes based on water chemistry signatures and can assist with assessing the potability and suitability of water for drinking purposes and other uses in the region. If feasible, the Program should work with data users to determine site-specific and region-wide needs and incorporate these in sub-projects or into the Upper Columbia Basin Groundwater Monitoring Program.

The Program should continue to collect and share scientifically defensible data at existing and new sites. A minimum of five years of data are needed to conduct temporal trend analyses and therefore on-going monitoring of existing sites is a priority. New sites should be selected based on their relevance for supporting regulatory, planning, and research needs. Expansion of the Program to include more wells across a range of climatic, geological, topographical, hydrological, land cover, and water use conditions in the Basin will provide more information to support groundwater management and protection. Continued efforts to share data, including making them publicly available and outreach to the data users such as communities, governments, academia, and consultants, will ensure maximum use of the data. Through collaborative Programs, such as Living Lakes Canada's Upper Columbia Basin Groundwater Monitoring Program, the region will be able to collect, manage, and share data that benefit human and ecological needs.

5 Report Closure

Findings and conclusions presented herein are based on available information at the time of the study. The work has been carried out in accordance with generally accepted engineering practice. No other warranty is made, either expressed or implied. Engineering judgement has been applied in producing this report.

This report was prepared by personnel with professional experience in the fields covered.

We were pleased to produce this document. If you have any questions, please contact us.

Yours truly,



Carol Luttmer, BSc (Eng), M.Sc.
C Waters Consulting
carol.luttmer@gmail.com
carol@livinglakescanada.ca



Antonio Barroso, M.Sc, P.Eng
Hydrogeologist, GW Solutions
abarroso@gwsolutions.ca

Appendix A: Description of information included on the *Well Information Sheets*

The following information is presented in the *Monitoring Well Information Sheets*:

Well Station ID: The Volunteer Observation Well (VOW) station ID number assigned by Living Lakes Canada.

Location Description: A general description of the well location, nearest community, road or landmark.

Reason for monitoring: Reason why well is included in the Upper Columbia Basin Groundwater Monitoring Program.

General Well Information

Location Well Tag Number: The Well Tag Number (WTN) is assigned by the Province and the number associated with the well registration in [GWELLS](#)¹⁵.

Well Plate ID: The number on the metal plate attached to the well. Not all wells registered in GWELLS have Well Plate IDs and wells with Well Plate IDs may not be registered in GWELLS.

Owner Well ID: Any other well ID that may be used in reports or by the well owner.

EMS #: The Environmental Monitoring System (EMS) site number for wells with analytical results in the Provincial [EMS database](#)¹⁶.

Latitude: Decimal degrees to 6 decimal places.

Longitude: Decimal degrees to 6 decimal places.

Source of Location Coordinates: Source or accuracy of location coordinates.

Well Stick-up (m): The distance of the well casing that extends above the ground surface. This is typically taken from the well construction report or measured in the field during equipment installation, unless otherwise noted and is used to convert water level readings from meters below top of casing (mtoc) to meters below ground surface (mbgs).

Well Depth (mbgs): The depth of the well in meters below ground surface (mbgs). This is typically taken from the well construction report, unless otherwise noted.

Well Casing: Indicates the type of well casing.

Top of Screen (mbgs): The location of the top of the screen in meters below ground surface, generally taken from the well construction report.

Bottom of Screen (mbgs): The location of the bottom of the screen in meters below ground surface, generally taken from the well construction report.

¹⁵ <https://apps.nrs.gov.bc.ca/gwells/>

¹⁶ <https://www2.gov.bc.ca/gov/content/environment/research-monitoring-reporting/monitoring/environmental-monitoring-system>

Confining Layers: A zone in the subsurface that prevents the movement of groundwater. A confining layer is synonymous with a material being impervious to the flow of water (i.e. a thick layer of clay is a confining layer). The lithology information can help determine if a well is in the confined or unconfined region within an aquifer. Many aquifers in the Columbia Basin are partially confined. This may also help identify if the well is monitoring a particular aquifer.

Reason for monitoring: The initial intention of why the well was added to the Columbia Basin Groundwater Monitoring Program.

Initial Well Use/Reason for well construction: The original intended use of the well or the reason for its construction.

Monitoring Information:

Monitoring Status: The status of the monitoring at the time of this report.

Length of Monitoring Record: The length of groundwater level data available for the well.

Data available on BC Real-time Water Data Website: Yes/No, indicating if the water level data are available on the BC Real-time Water Data Website.

Monitoring Interval: Frequency the data logger collects a water level measurement.

Water Level Sensor: The type of water level sensor.

Water Level Sensor Depth (mbgs): The installed depth of the water level sensor in meters below ground surface.

Barometric Pressure Sensor: The type of barometric sensor used for compensating water pressure for barometric pressure, and the location of the sensor.

Data Logger Type: The type of data logger.

Comments: Provides any additional information on the well, maintenance or well upgrades that have been conducted, and any other information on the monitoring that could be useful for data interpretation.

Nearest meteorological station with a complete precipitation record

Climate Network Name: Climate Network Name

Climate Station Location/Name: Climate Station Location/Name

Climate Station Number: Climate Station Number

Aquifer Information

Aquifer: The provincially mapped aquifer number associated with the well. The associated aquifer is sometimes reported in the GWELLS database. If no associated aquifer is defined in GWELLS, the well construction, lithology, location, and static water level are reviewed to determine if the well can be associated with a provincially mapped aquifer.

Aquifer Material: The dominant aquifer material defined in GWELLS.

Aquifer Area (km²): The areal extent of the aquifer defined in GWELLS.

Aquifer Confinement: Information on aquifer confinement, generally taken from the aquifer mapping report in GWELLS. The confinement classification on GWELLS is generally listed as confined or unconfined. However, many aquifers in the Columbia are partially confined.

Description: Description of the aquifer from the Aquifer Factsheets.

Likelihood of hydraulic connection (Aquifer Factsheet): The likelihood of hydraulic connection between groundwater in an aquifer and water in a stream based on a broad regional assessment as reported on the [Aquifer Factsheets in GWELLS](#)¹⁷.

Hydraulic Connection Assessment by LLC: Indicates if hydraulic connectivity between the aquifer being monitored and surface water is likely based on the provincial guidance for determining the effect of diversion of groundwater on specific streams¹⁸. This is a preliminary high-level assessment based on information from iMapBC, GWELLS, and Google Earth. It was completed in 2017 by LLC's advisors.

Rational for hydraulic connection assessment by LLC: Provides rational for the hydraulic connectivity assessment conducted by LLC's advisors.

¹⁷ <https://apps.nrs.gov.bc.ca/gwells/aquifers>

¹⁸ Province of British Columbia. (2016). Determining the Likelihood of Hydraulic Connection – Guidance for the Purpose of Apportioning Demand from Diversion of Groundwater on Streams. Water Science Series, WSS2016-01, 26. Retrieved from: http://a100.gov.bc.ca/appsdata/acat/documents/r50832/HydraulicConnectMW3_1474311684426_4310694949.pdf

**Appendix B – Well location maps, well information sheets,
well construction logs, and interpretative graphs for Volunteer
Observation Wells**

Monitoring Location: VOW_01 - Athalmer, Near Wastewater Treatment Plant

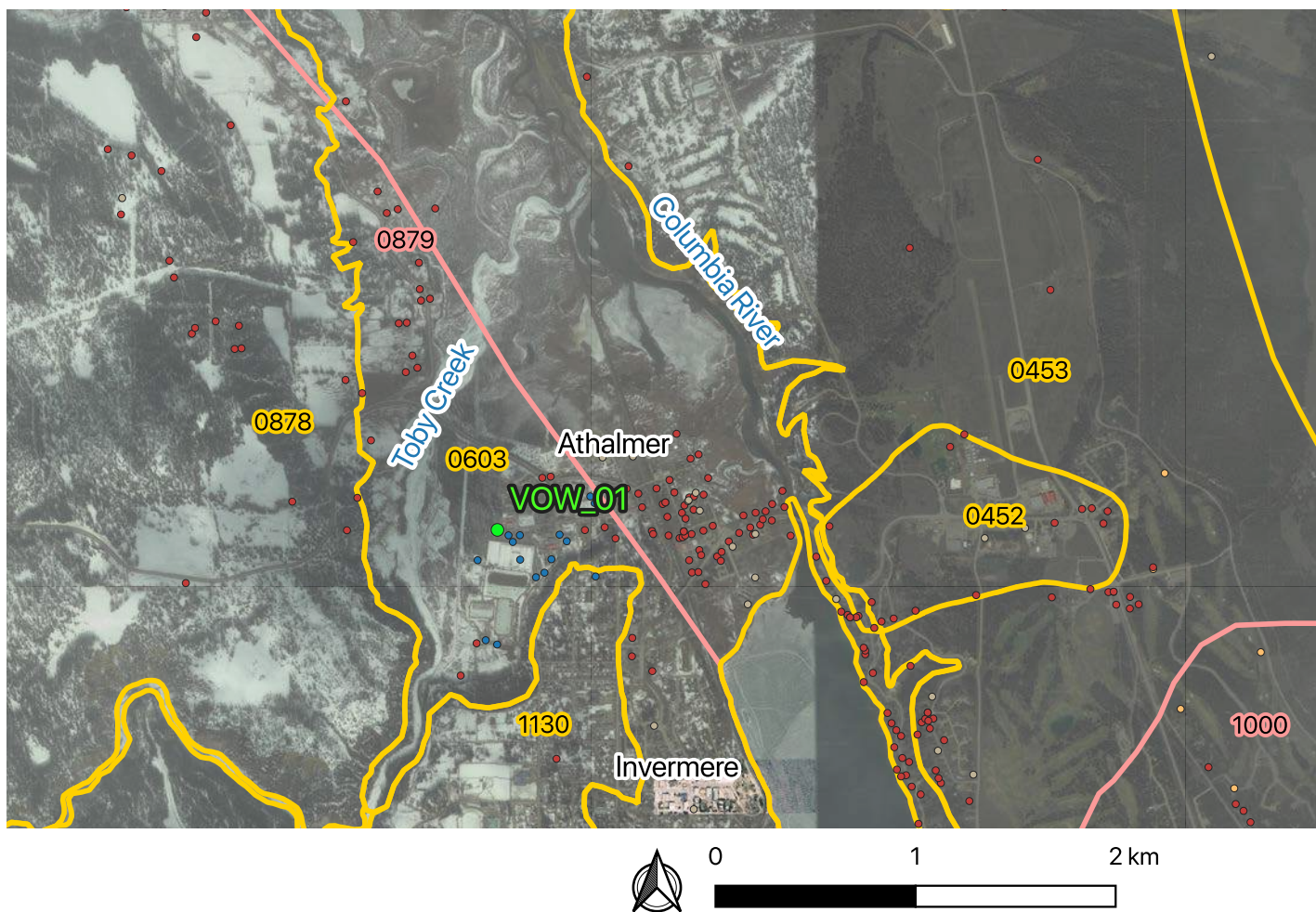

Legend

Living Lakes Canada

Volunteer Observation Well (VOW)

- Active

Provincially Mapped Aquifers

- ▭ Bedrock Aquifer
- ▭ Sand & Gravel Aquifer

Wells registered in GWELLS

- Well Decommissioned
- Well assigned to a Mapped Aquifer
- Well not assigned to a Mapped Aquifer

Environmental Monitoring System

Groundwater Sampling

- Spring or Hot Spring
- Well
- Monitoring Well
- Contaminated Site
- Observation Well

Data Sources

-BC Data Catalogue (Groundwater Aquifers, Jun 4 2019; GWELLS, May 9 2019; Environmental Monitoring System, May 29 2019; BC Geographical Names, Dec 13 2019)
 -Google Satellite

Coordinate Reference System: WGS 84 / UTM Zone 11N (EPSG: 32611)

Well Station ID: LLC_VOW_01

Location Description: District of Invermere; Althamer near wastewater treatment plant.

Reason for monitoring: Aquifer 603 identified as priority for monitoring in 2009 PGOWN Review and suggested by FLNRORD.

Well Information

Well Tag Number:	None	Well ID # from owner:	115
Well Plate ID:	None		
Well Stick up (m):	0.7	EMS # :	E207277
Well Depth (mbgs):	8.47 (measured with water level tape)	Latitude:	50.515251
Well Casing:	4.5" PVC	Longitude:	-116.040475
		Source of Location	
Top of Screen (mbgs):	Unknown	Coordinates:	
Bottom of Screen (mbgs):	Unknown		Handheld GPS
Confining Layers:	No lithology information available for this well. Likely no confining layers based on lithology information from nearby wells.		

**Initial Well Use/Reason
for well construction:** Monitoring well, likely associated with Waste Water Treatment Plant.

Monitoring Information

Monitoring Status: Active

Monitoring Interval: 2013-10-12 to 2016-08-10 - Daily; 2016-08-10 to 2018-05-07 - 6 hours;
2018-05-07-present - Hourly

Length of Monitoring Record: 2013-10-12 to Current

Data available on BC Real-time Water

Data Website? Yes

Water Level Sensor: HOBO U20-001-04 (Range-4m)

Barometric Pressure Sensor: HOBO U20-001-04 / installed in well

Data Logger Type: HOBO U20

Water Level Sensor Depth (mbgs): 5.97

Comments: District of Invermere Water Treatment Plant operators collect weekly water levels in other wells around treatment plant. This well is not monitored as part of the water treatment plant operations. Operators have observed that the main influence on water levels in the area is the water level in Toby Creek. Toby Creek experiences large fluctuations in the late fall and early winter, which may be due to ice jamming and then freeing with late fall/early winter temperature fluctuations. For comparison to precipitation data, should check Ministry of Transport and Infrastructure and Ministry of Forests, Lands, and Natural Resources Operations and Rural Development Climate Station data that may be more representative of local conditions.

Nearest climate station with a complete precipitation record

Climate Network Name: Environment Canada (Canadian Daily Climate Data)

Climate Station Location/Name: GOLDEN A

Climate Station Number: 1364

Aquifer Information

Aquifer #:	603 (assumed based on well location)
Aquifer Material:	Sand and gravel
Aquifer Area (km²):	13
Aquifer Confinement:	Mostly unconfined
Description¹:	Predominantly unconfined fluvial or glaciofluvial sand and gravel Aquifers found along rivers of moderate stream order with the potential to be hydraulically influenced by the river (subtype = 1b).
Likelihood of hydraulic connection¹:	Likely (based on broad regional assessment)
Hydraulic Connection Assessment by LLC²:	Likely connected to Toby Creek and the Columbia River.
Rational for Hydraulic Connection Assessment by LLC³:	Direction of GW flow - towards Columbia River. Eastern and Western limits may follow topography gradient, i.e. river valley. Recharge from precipitation and lateral flow from upslope unconsolidated aquifers 0453 & 0878 to the west. There also may be a hydraulic connection with Toby Creek and the Columbia River.

¹From Provincial aquifer factsheets available at <https://apps.nrs.gov.bc.ca/gwells/aquifers>

²Assessed by Living Lakes Canada. See methods in report.

³See methods in report.

Water Level & Water Temperature Station ID: LLC_VOW_01

Station ID
LLC_VOW_01

Measurement Type

- Manual data
- Logger data

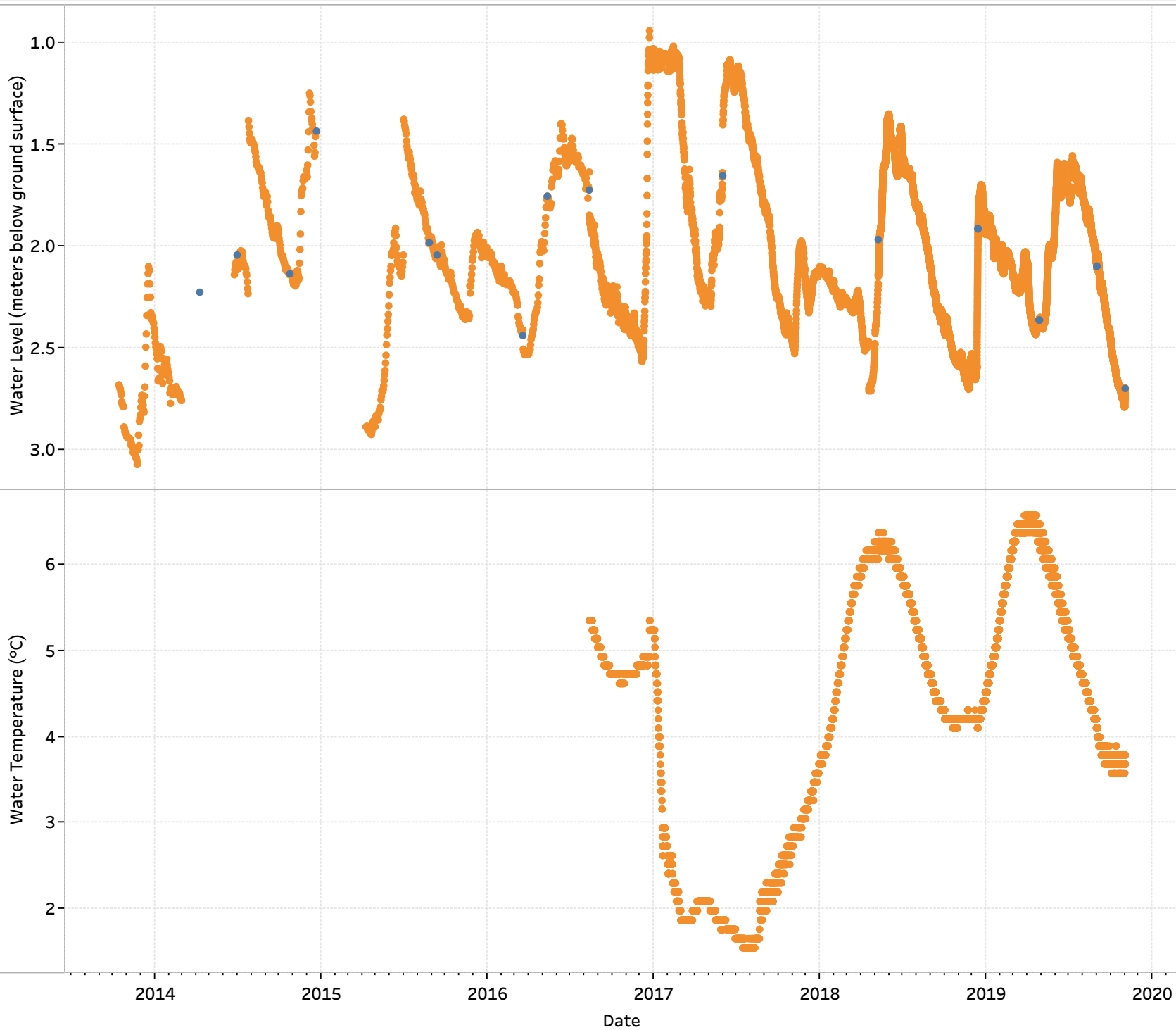

Well depth (mbgs)

8.47 (measured with water level tape)

Depth of Water Level Sensor (mbgs)

5.97 mbgs



Graphs produced by:

C Waters Consulting



GW SOLUTIONS
ASSESSMENT & PROTECTION OF GROUNDWATER

Water Level & Daily Total Precipitation

Station ID: LLC_VOW_01

Station ID Groundwater
LLC_VOW_01

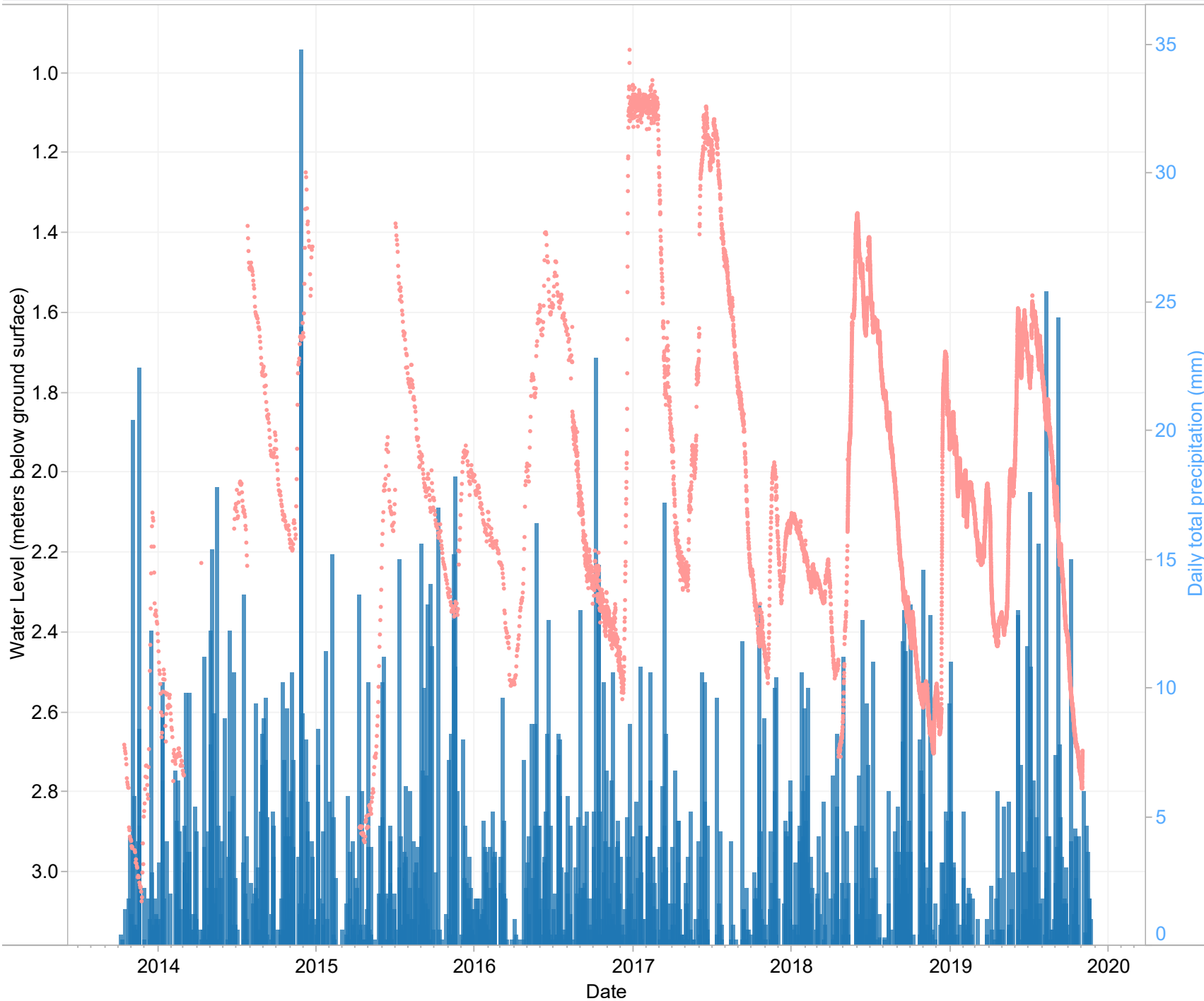

Station ID Legend
■ 1364
■ LLC_VOW_01

Precipitation	1364	GOLDEN A
Groundwater LLC_VOW_01		

District of Invermere; Althamer near wastewater treatment plant.



Graphs produced by:

C Waters Consulting



Water Level & Cumulative Precipitation Departure from Average (CPD)

Station ID: LLC_VOW_01

Station ID Groundwater
LLC_VOW_01

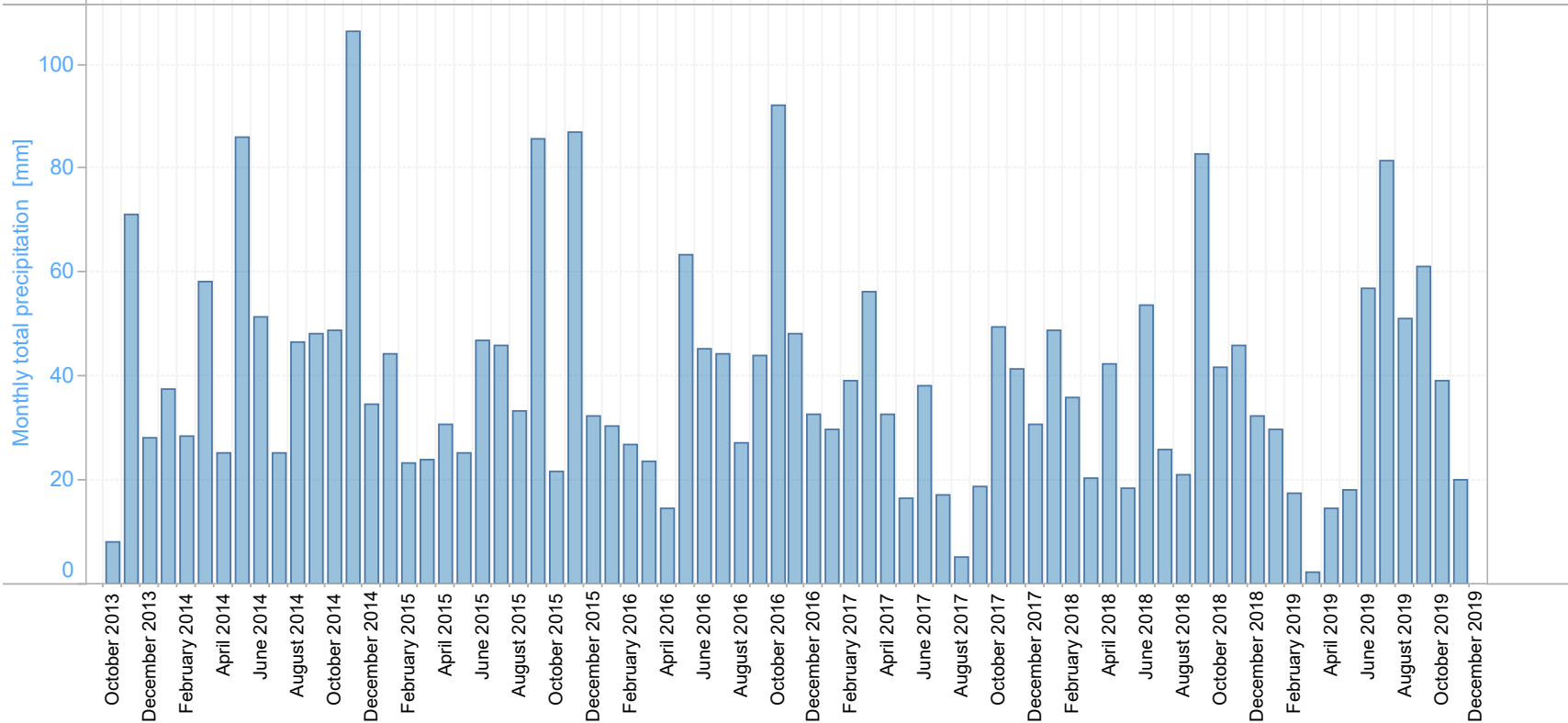
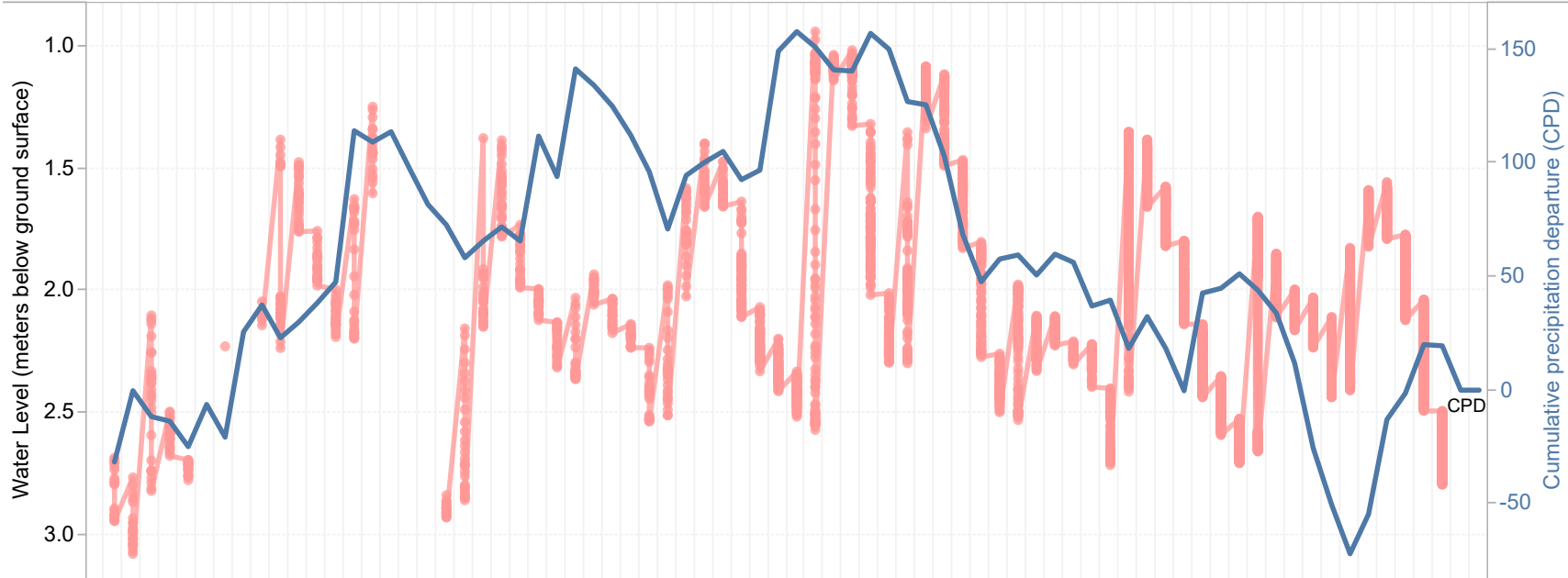

Graphs produced by:

C Waters
Consulting



Historical daily flow data for COLUMBIA RIVER AT ATHALMER & LLC_VOW_01 (All)

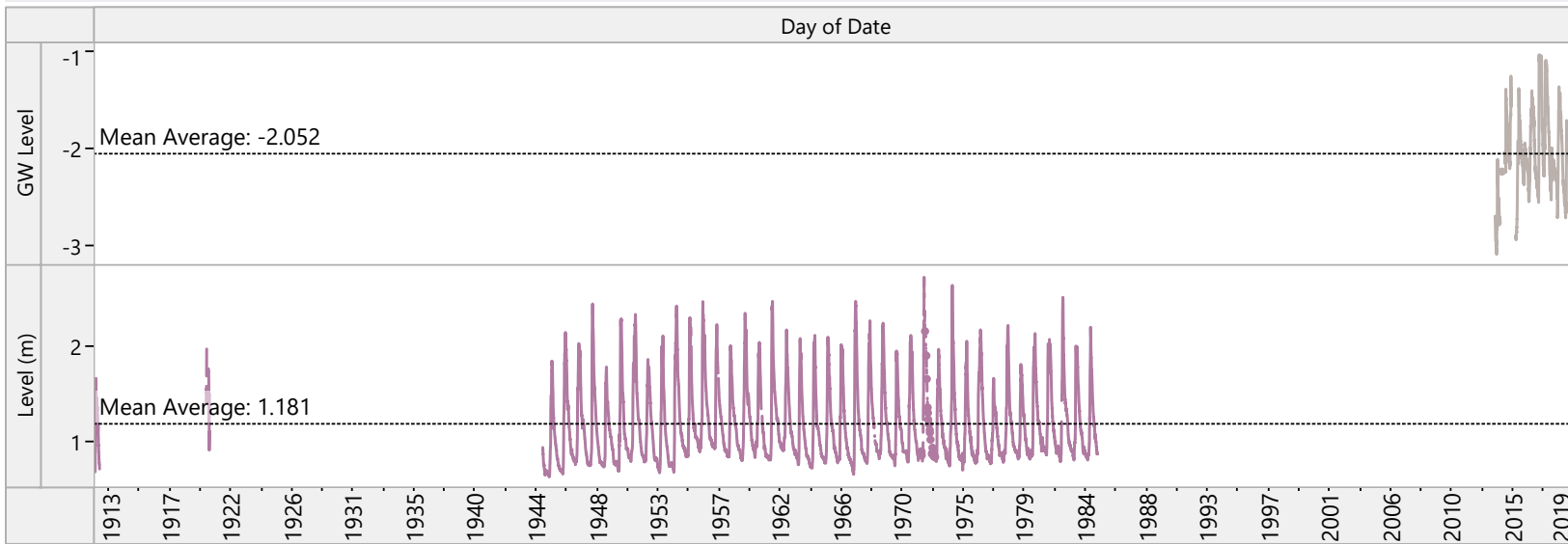

Parameter
Multiple values

Station Status
● ACTIVE
▼ DISCONTINUED

Station ID
■ 08NA004
■ LLC_VOW_01

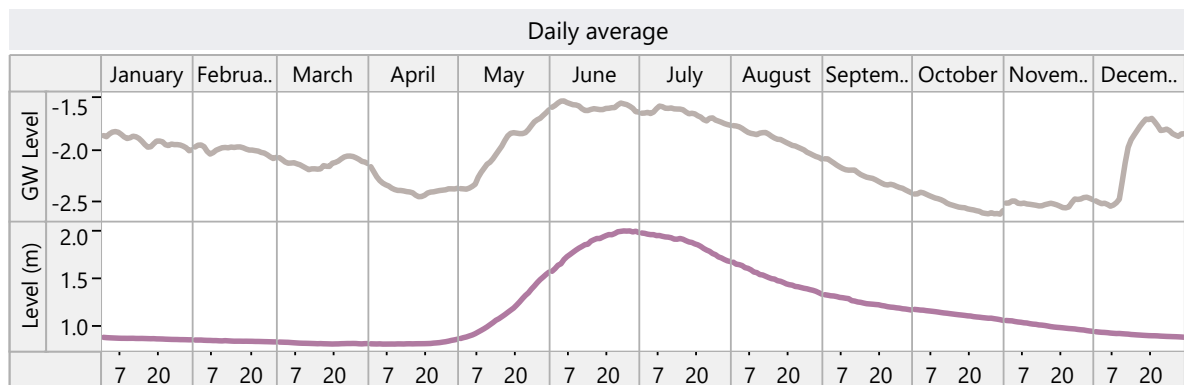
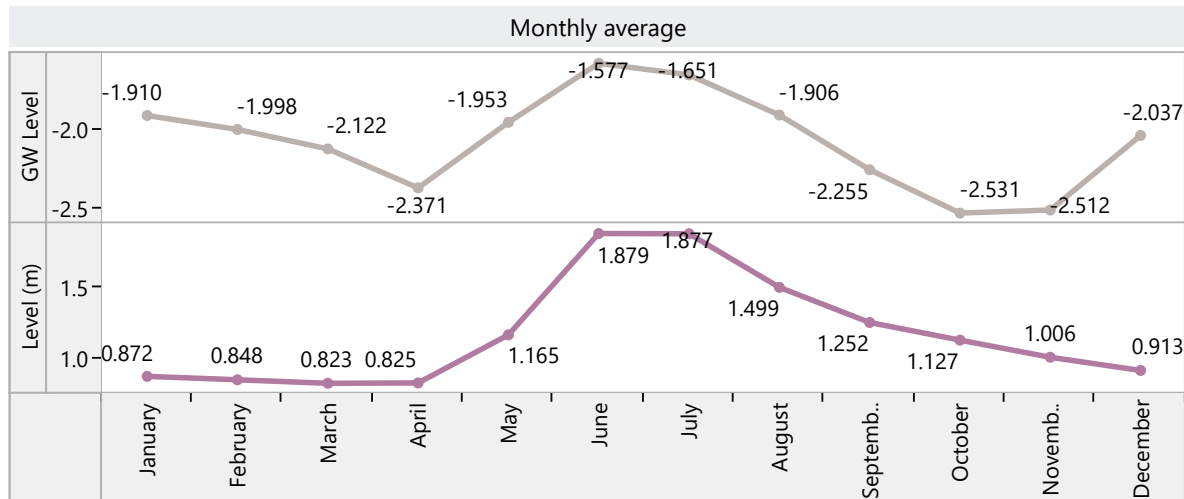
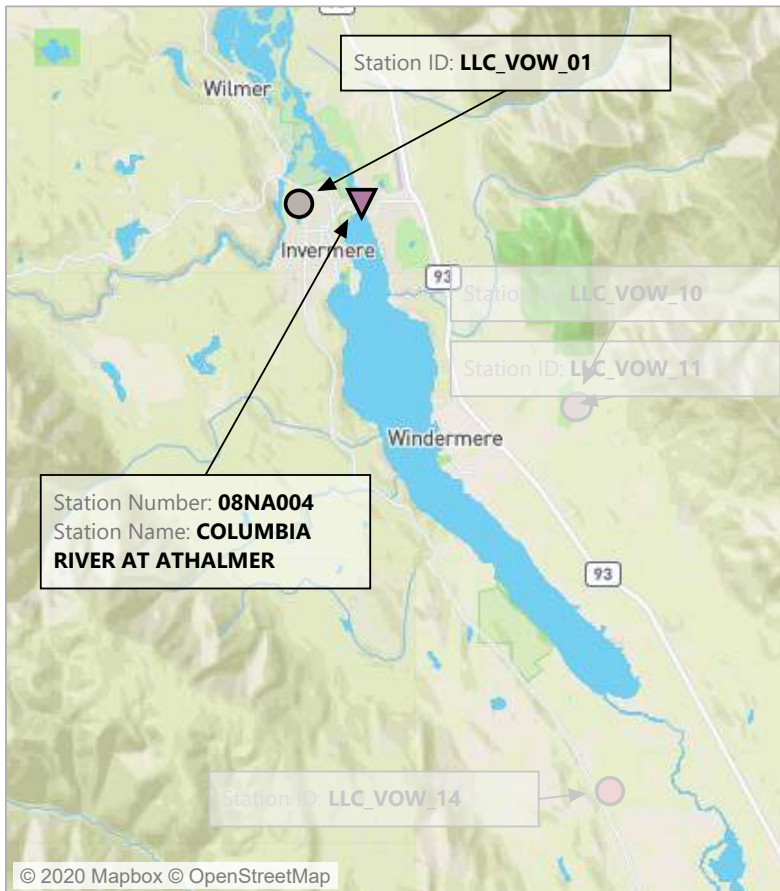

Water Level Yearly Comparison LLC_VOW_01

Station ID
LLC_VOW_01

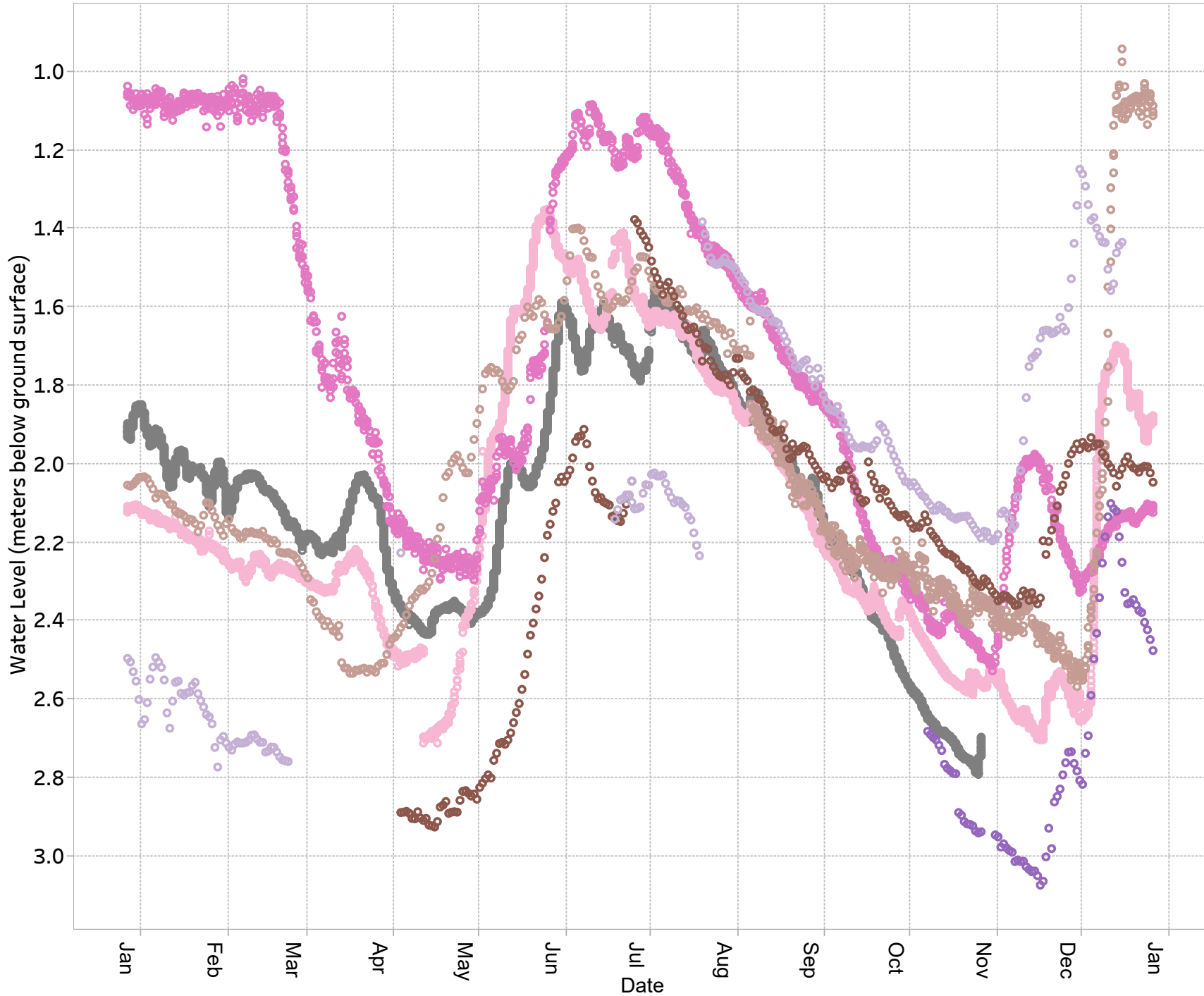

YEAR

- 2013
- 2014
- 2015
- 2016
- 2017
- 2018
- 2019



Graphs produced by:

C Waters
Consulting



Monitoring Location: VOW_02 - Creston, S Goat River Road.



Legend

**Living Lakes Canada
Volunteer Observation Well (VOW)**

- Active

Provincially Mapped Aquifers

- ▭ Bedrock Aquifer
- ▭ Sand & Gravel Aquifer

Wells registered in GWELLS

- Well Decommissioned
- Well assigned to a Mapped Aquifer
- Well not assigned to a Mapped Aquifer

Environmental Monitoring System

Groundwater Sampling

- Spring or Hot Spring
- Well
- Monitoring Well
- Contaminated Site
- Observation Well

Climate Station

- ◆ Environment and Climate Change Canada

Data Sources

- BC Data Catalogue (Groundwater Aquifers, Jun 4 2019; GWELLS, May 9 2019; Environmental Monitoring System, May 29 2019; BC Geographical Names, Dec 13 2019)
- Pacific Climate Impacts Consortium (BC Station Data, Nov 29 2019)
- Google Satellite

Coordinate Reference System: WGS 84 / UTM Zone 11N (EPSG: 32611)

Well Station ID: LLC_VOW_02

Location Description: Creston, S Goat River Road.

Reason for monitoring: Aquifer 487 identified as priority for monitoring in 2009 PGOWN Review and suggested by FLNRORD.

Well Information

Well Tag Number:	106697	Well ID # from owner:	n/a
Well Plate ID:	30483		
Well Stick up (m):	0.965	EMS #	n/a
Well Depth (m):	24.4	Latitude:	49.074912
Well Casing:	6" Steel	Longitude:	-116.491529
		Source of Location	
Top of Screen (mbgs):	No screen reported.	Coordinates:	GWELLS Database
Bottom of Screen (mbgs):	No screen reported.		(Handheld GPS)
Confining Layers:	Gravel and clay from 17.98 to 21.34 mbgs.		
Initial Well Use/Reason for well construction:	Monitoring to investigate water supply.		

Monitoring Information

Monitoring Status: Active

Monitoring Interval: 2017-02-03 to 2018-07-19 - 30 minutes; 2018-07-19- present - 1 hour

Length of Monitoring Record: 2017-02-03 to Current

Data available on BC Real-time Water Data Website? Yes

Water Level Sensor: HOBO U20-001-04 (Range-4m)

Data Logger Type: HOBO U20

Barometric Pressure Sensor: HOBO U20-001-04 / installed in well

Water Level Sensor Depth (mbgs): 10.1 mbgs then lowered to 10.8 mbgs on 2018-07-19.

Comments: The Aquifer Classification worksheet states "Well records indicate the surficial geology within the floodplain is quite complex... This area requires further groundwater exploration. Although two domestic wells show the upper fluvial material to be water bearing and high capacity there is insufficient data to differentiate between the two different depositional environments; fluvial and glacio-fluvial. Only the lower glacio-fluvial aquifer has been delineated." The Aquifer Classification Worksheet and Aquifer Factsheet for Aquifer 487 provide conflicting information. The Aquifer Factsheet states 487 is unconfined while the Aquifer Classification worksheet states that it is confined. The data gaps from 2017-07-03 to 2018-01-23 and from 2018-06-29 to 2018-07-05 are associated with setting up the data logger.

Nearest climate station with a complete record

Climate Network Name: Environment Canada (Canadian Daily Climate Data)

Climate Station Location/Name: Creston Campbell Scientific

Climate Station Number: 6838

Aquifer Information

Aquifer #:	Potentially aquifer 487. Need to confirm.
Aquifer Material:	Sands and gravels of fluvial or glacio-fluvial origin (from Aquifer Classification Worksheet).
Aquifer Area (km²):	10. 3 (Aquifer 487)
Aquifer Confinement:	Aquifer factsheet states unconfined. Aquifer Classification Worksheet states confined.
Description¹:	Unconfined glacio-fluvial outwash or ice contact sand and gravel aquifers generally formed near or at the end of the last period of glaciation (subtype = 4a). (Note this conflicts with some of the information in the Aquifer Classification Worksheet).
Likelihood of hydraulic connection¹:	Likely (based on broad regional assessment)
Hydraulic Connection Assessment by LLC²:	Likely connected to the Goat River
Rational for Hydraulic Connection Assessment by LLC³:	The well is installed in a generally flat floodplain, sand and gravel aquifer locally confined by valley walls along the north and south of the river edge and meander belt. Likely connected to the Goat River.

Foot Notes

¹From Provincial aquifer factsheets available at <https://apps.nrs.gov.bc.ca/gwells/aquifers>

²Assessed by Living Lakes Canada. See methods in report.

³Rational for hydraulic connectivity assessment by Living Lakes Canada.



GW SOLUTIONS
ASSESSMENT & PROTECTION OF GROUNDWATER



WELL ID:
LLC_VOW_02

EASTING: 537135
NORTHING: 5435908
DATE COMMENCED: 06 August, 2012
DATE COMPLETED: 08 August, 2012

LOCATION: Columbia Basin
CONTRACTOR: Wild West Drilling
STICK UP (m): 0.96

WELL ID PLATE No.: 30483
BC WELL TAG No.: 106697
DRILL RIG: Air rotary
DRILLER: Chris Barling
LOGGED BY: Driller

Graph log		Log description	Well construction details	
ft	m		ft	m
0	0			
4				
8				
12				
16	5			
20		unknown - sand and gravel?	20'	6.1
24				
28				
32	10			
36				
40	37			
44				
48		sand		
52	15			
56				
60	59			
64		clay and sand		
68	20			
72				
76	70			
80		unknown - sand?		
84	80			
	25			
			80'	24.4

8/6/2012

Logger
★

3 Bentonite Clay

6 inch Steel Casing

Water Level & Water Temperature Station ID: LLC_VOW_02

Station ID
LLC_VOW_02

Measurement Type

- Manual data
- Logger data

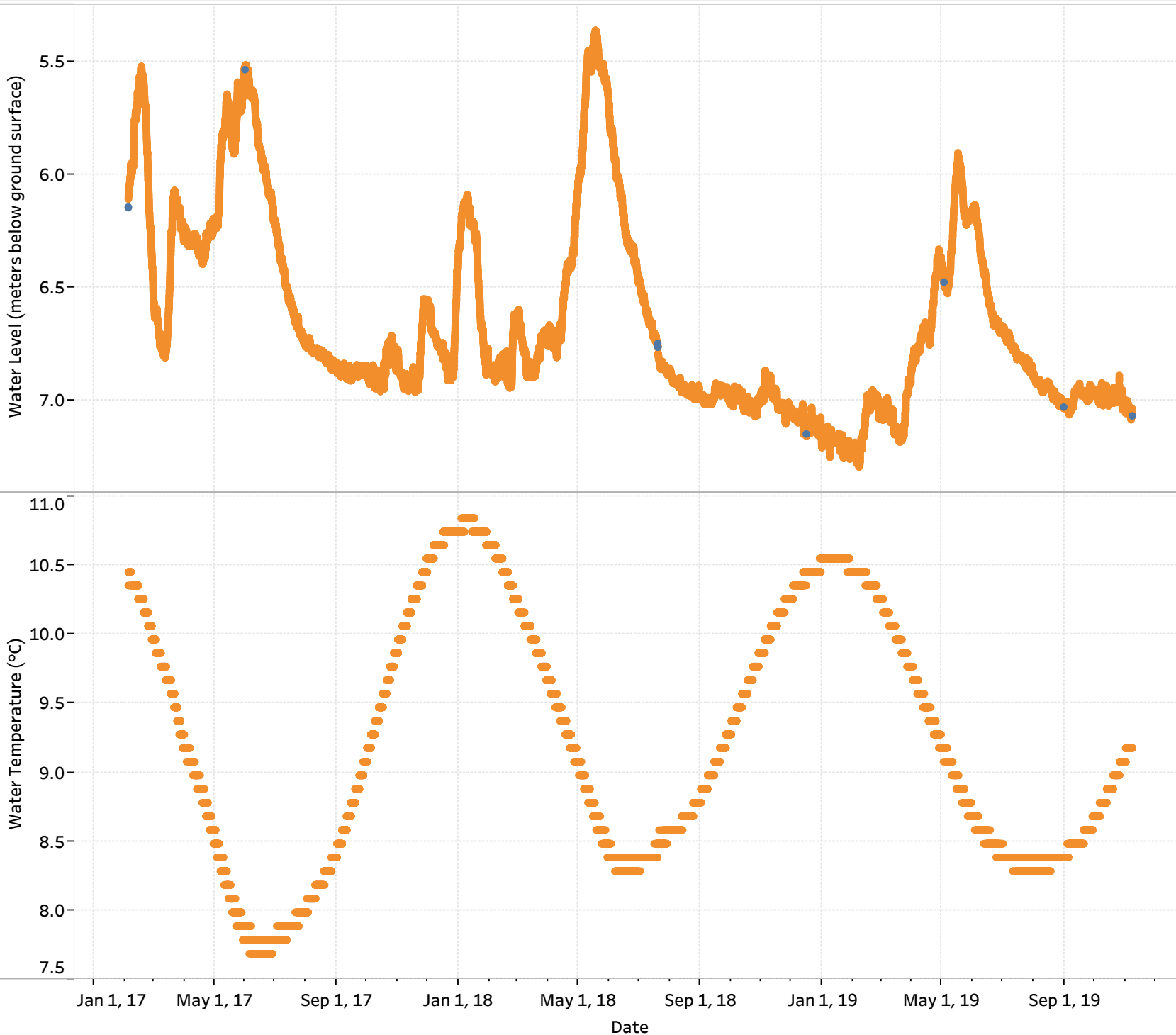

Well depth (mbgs)

24.4

Depth of Water Level
Sensor (mbgs)

10.1 mbgs then lowered to
10.8 mbgs on 2018-07-19.



Graphs produced by:

C Waters
Consulting



GW SOLUTIONS
ASSESSMENT & PROTECTION OF GROUNDWATER

Water Level & Daily Total Precipitation
Station ID: LLC_VOW_02

Station ID Groundwater
LLC_VOW_02

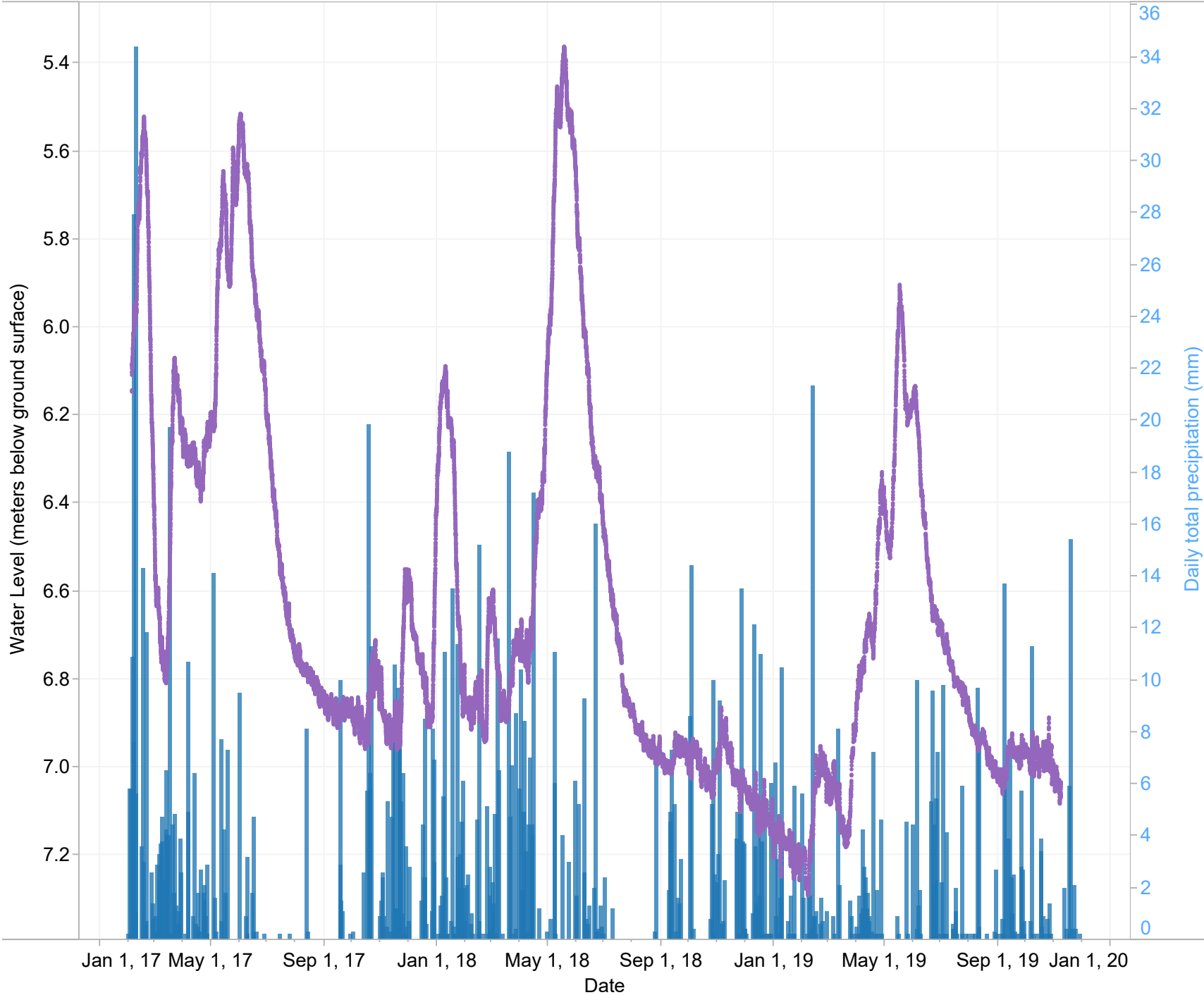

Station ID Legend

- 6838
- LLC_VOW_02

Precipitation	6838	CRESTON CAMPBELL SCIENTIFIC
Groundwater	LLC_VOW_02	Creston, S Goat River Road.



Graphs produced by:

C Waters Consulting



GW SOLUTIONS
ASSESSMENT & PROTECTION OF GROUNDWATER

Water Level & Cumulative Precipitation Departure from Average (CPD)

Station ID: LLC_VOW_02

Station ID Groundwater
LLC_VOW_02

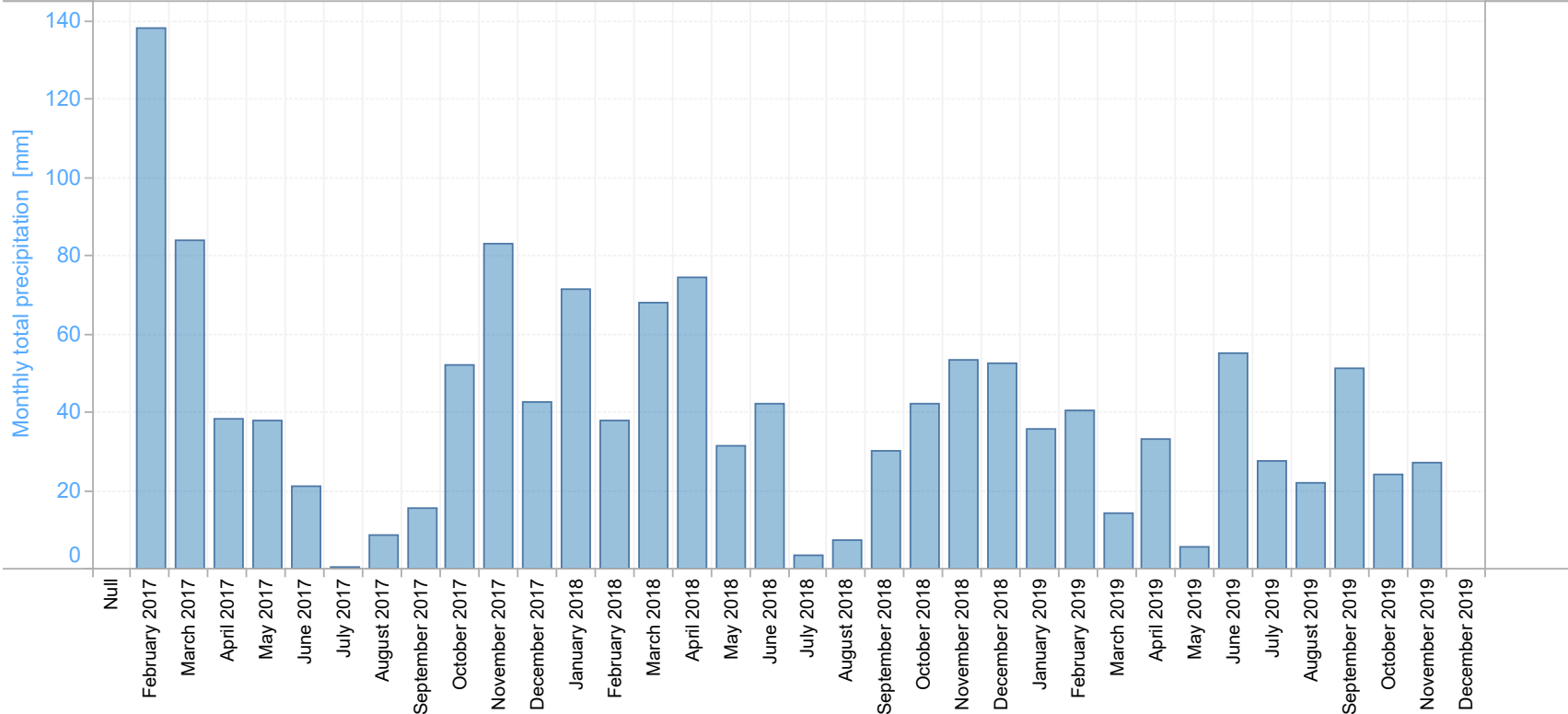
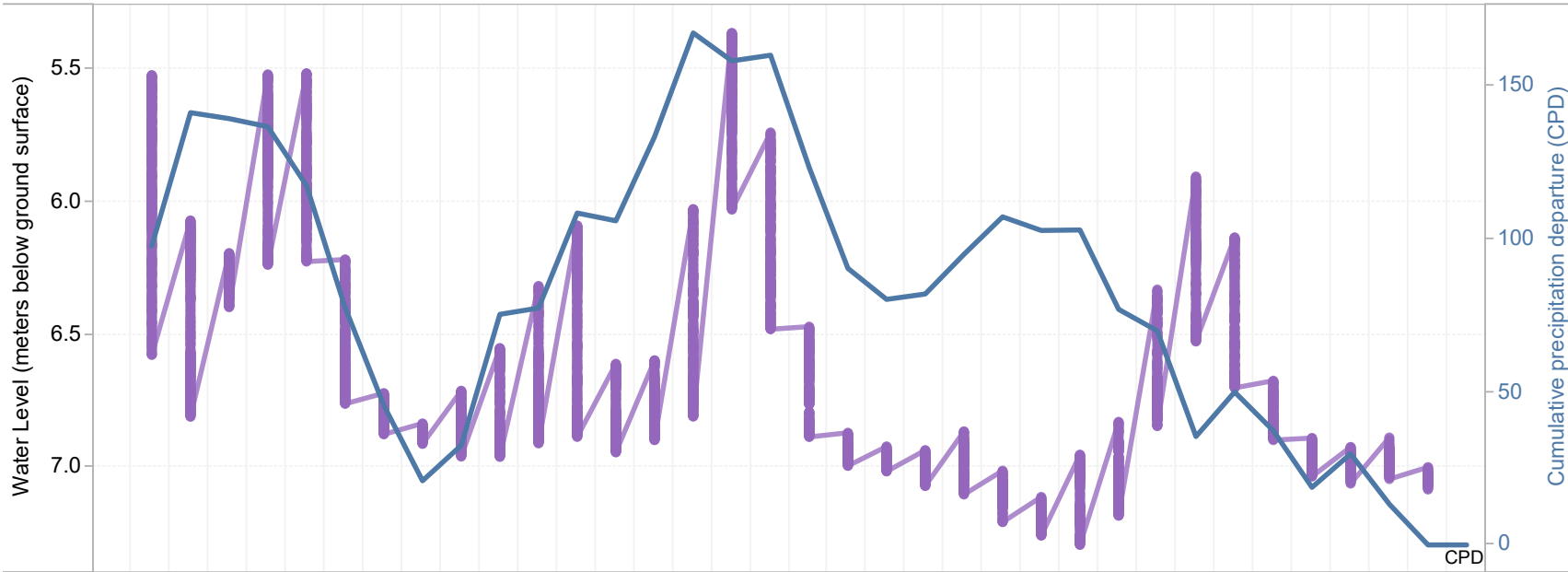

Graphs produced by:

C Waters Consulting



GW SOLUTIONS
ASSESSMENT & PROTECTION OF GROUNDWATER

Historical daily flow data for ARROW CREEK NEAR ERICKSON, LLC_VOW_02, SULLIVAN CREEK NEAR CANYON (All)

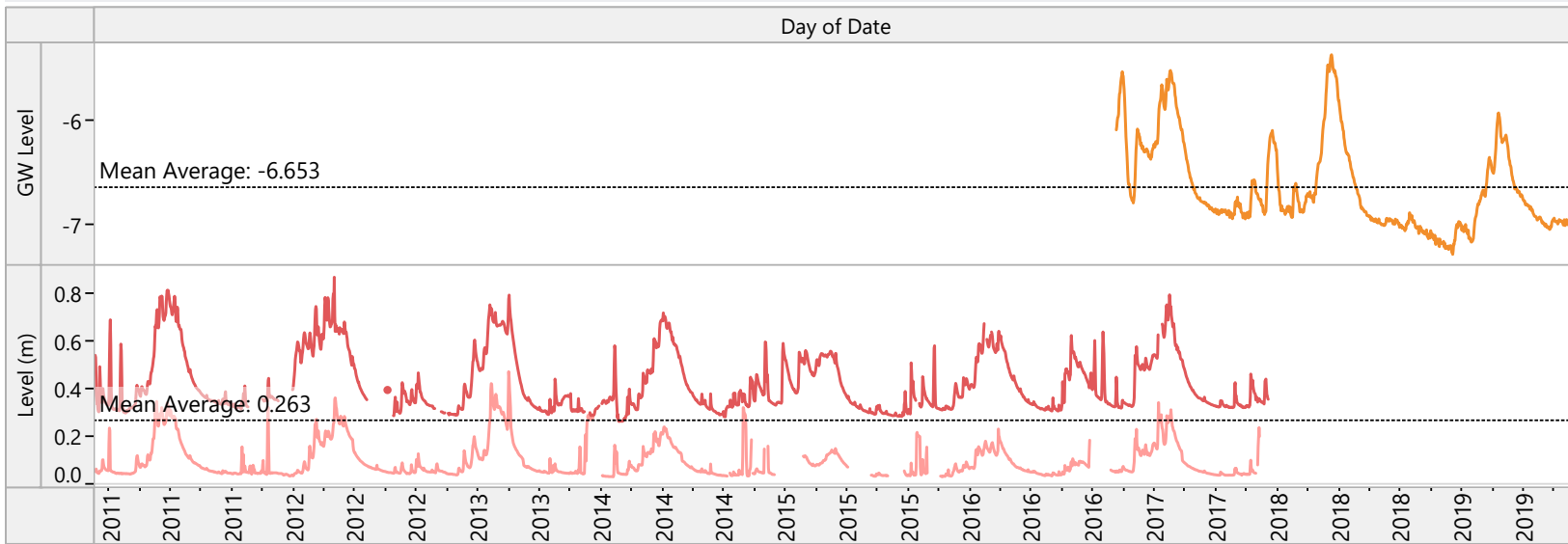

Parameter
Multiple values

Station Status
● ACTIVE
▼ DISCONTINUED

Station ID
■ 08NH084
■ 08NH115
■ LLC_VOW_02

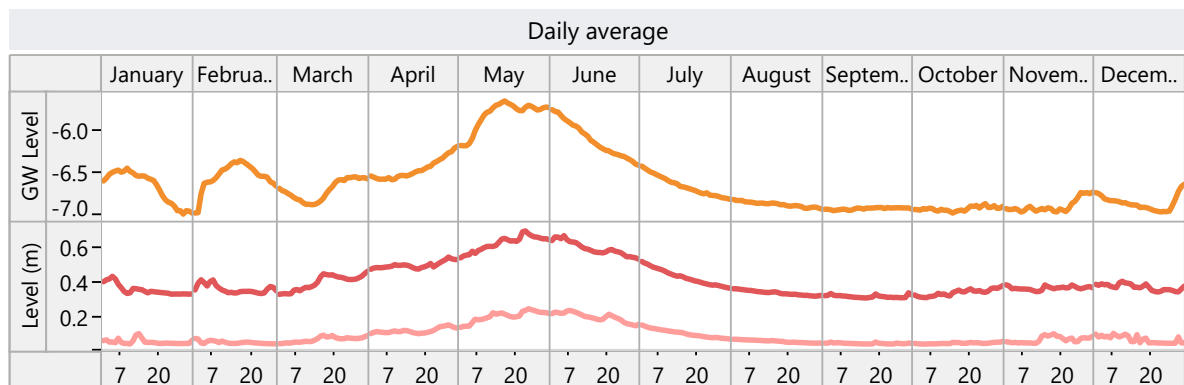
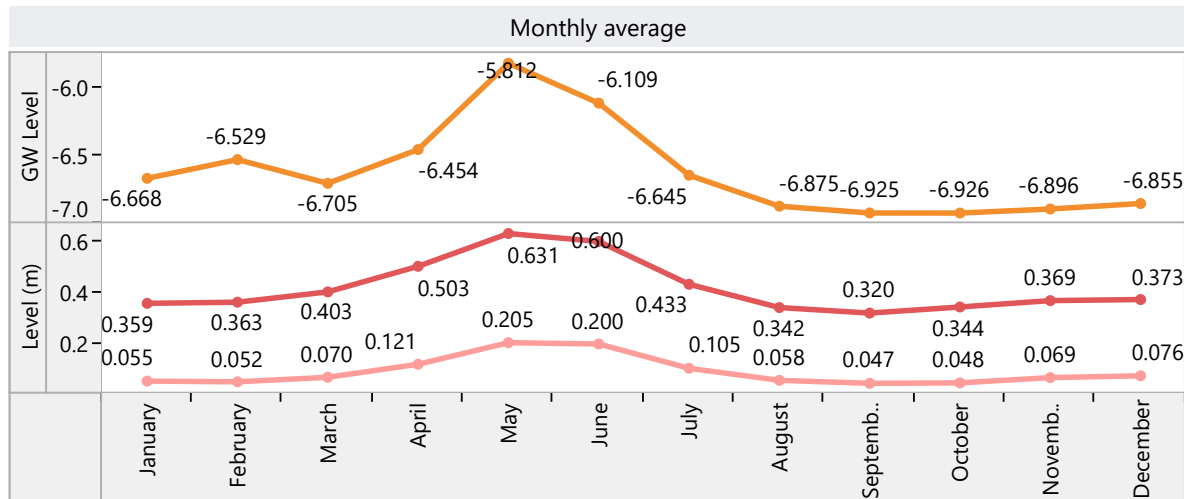
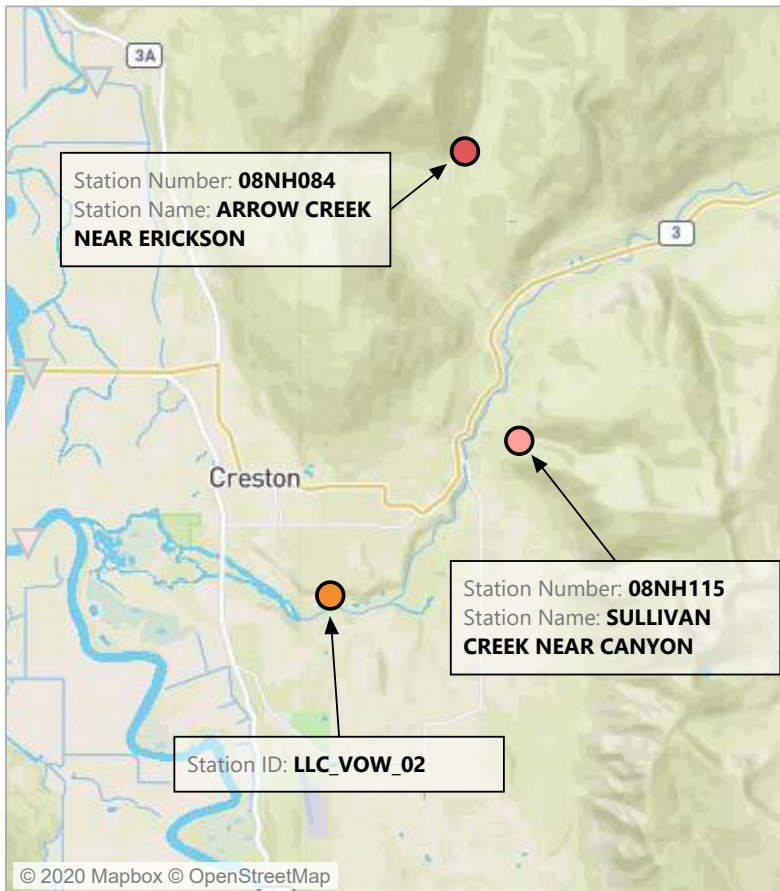

Water Level Yearly Comparison LLC_VOW_02

Station ID
LLC_VOW_02

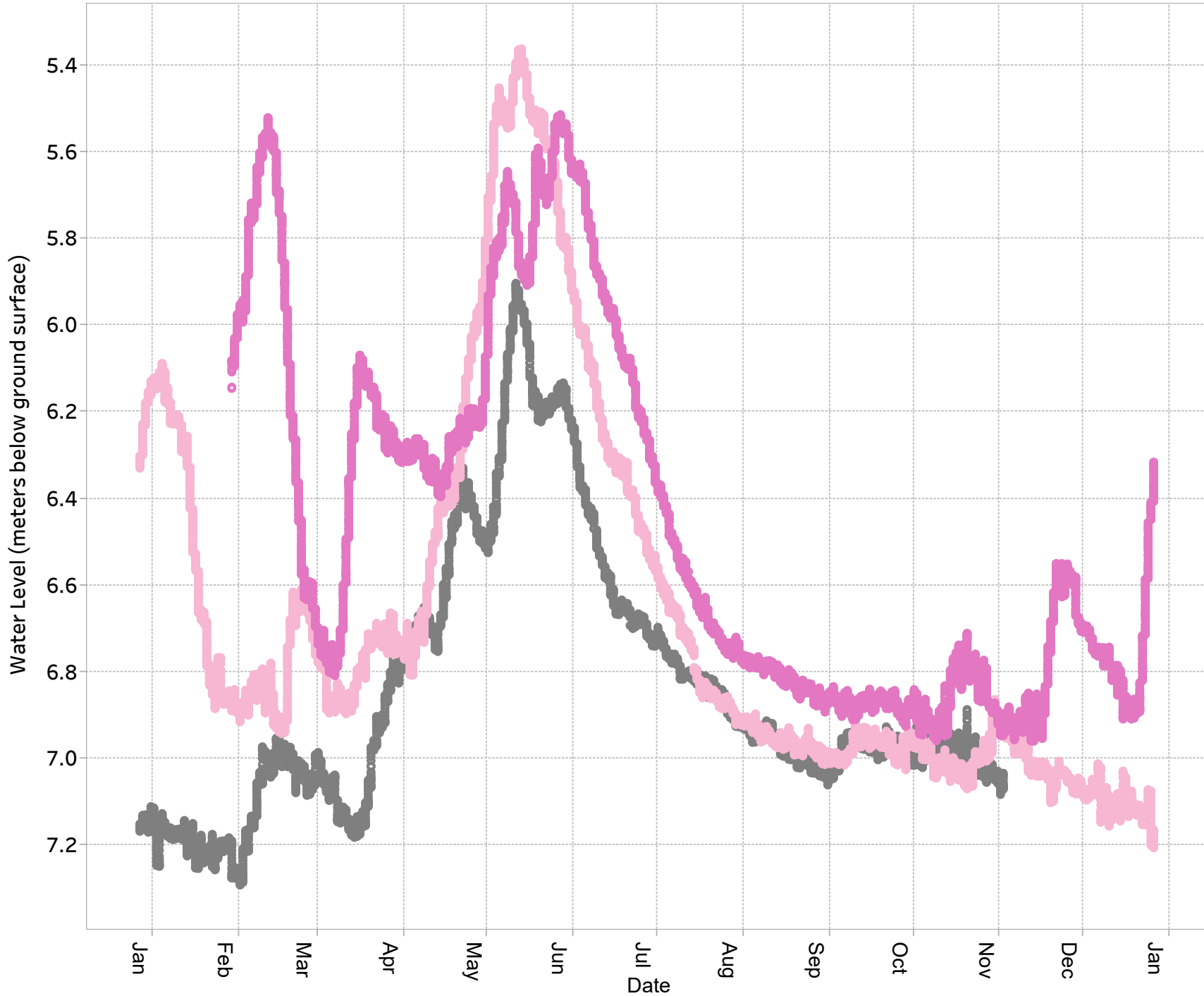

YEAR
2017
2018
2019



Graphs produced by:

C Waters
Consulting



Monitoring Location: VOW_03 - Blewett, Carlson Road East.

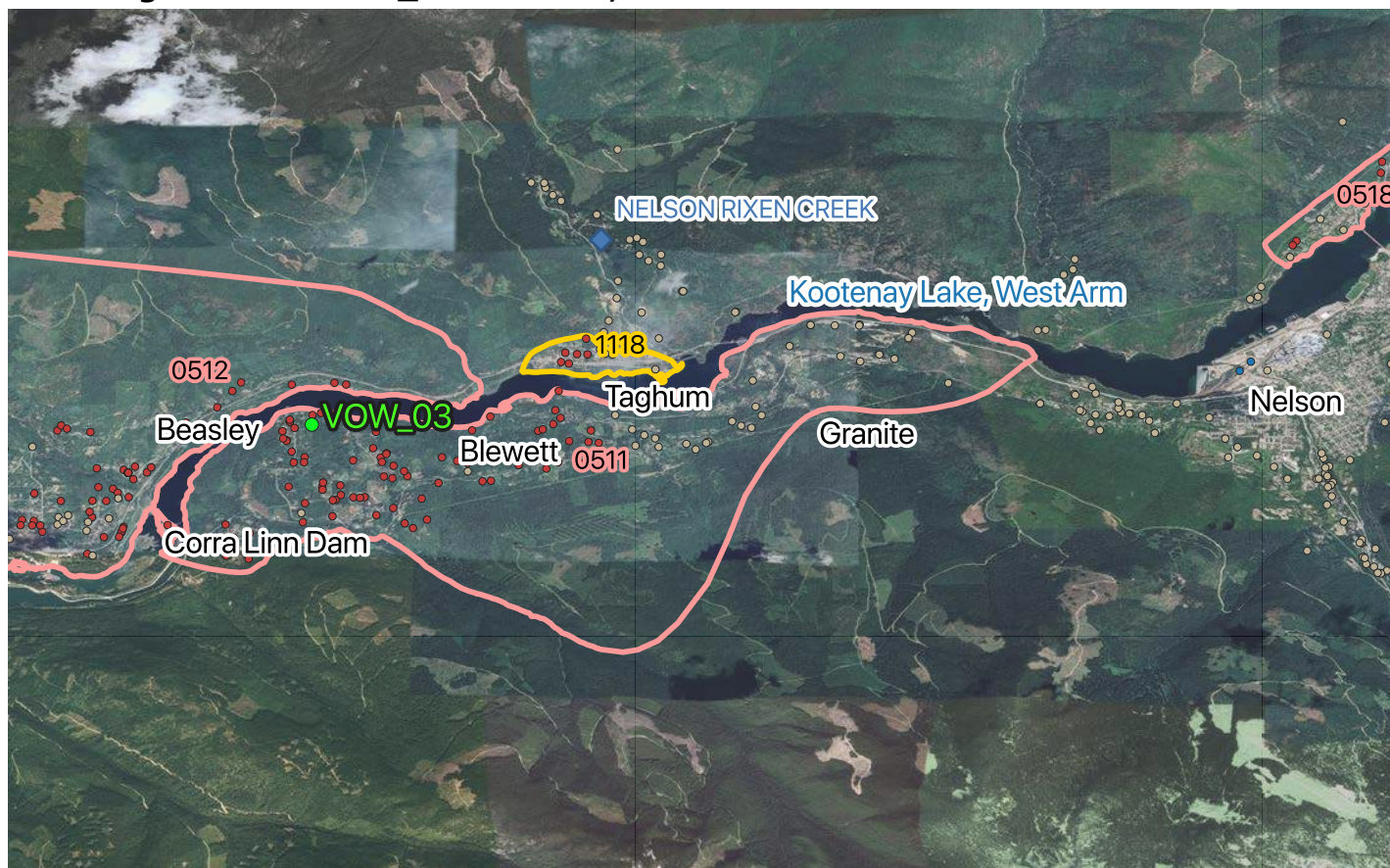

0 1 2 km



Legend

Living Lakes Canada

Volunteer Observation Well (VOW)

- Active

Provincially Mapped Aquifers

□ Bedrock Aquifer

□ Sand & Gravel Aquifer

Wells registered in GWELLS

- Well Decommissioned
- Well assigned to a Mapped Aquifer
- Well not assigned to a Mapped Aquifer

Environmental Monitoring System

Groundwater Sampling

- Spring or Hot Spring
- Well
- Monitoring Well
- Contaminated Site
- Observation Well

Climate Station

- ◆ Environment and Climate Change Canada

Data Sources

-BC Data Catalogue (Groundwater Aquifers, Jun 4 2019; GWELLS, May 9 2019; Environmental Monitoring System, May 29 2019; BC Geographical Names, Dec 13 2019)
 -Pacific Climate Impacts Consortium (BC Station Data, Nov 29 2019)
 -Google Satellite

Coordinate Reference System: WGS 84 / UTM Zone 11N (EPSG: 32611)

Well Station ID: LLC_VOW_03

Location Description: Blewett, Carlson Road East.
Reason for monitoring: Aquifer 511 identified as priority by FLNRORD; potential conflict among users.

Well Information

Well Tag Number:	87879	Well ID # from owner:	n/a
Well Plate ID:	17715		
Well Stick up (m):	0.508	EMS #	n/a
Well Depth (m):	140.2	Latitude:	49.481798
Well Casing:	6" Steel	Longitude:	-117.44414
		Source of Location	
Top of Screen (mbgs):	None	Coordinates:	GWELLS Database
Bottom of Screen (mbgs):	None		(Handheld GPS)
Confining Layers:	Granite from 2.44 mbgs(8') to 140.20 mbgs (460')		
Initial Well Use/Reason for well construction:	Domestic private water supply.		

Monitoring Information

Monitoring Status: Active
Monitoring Interval: 2016-09-20 to 2018-06-29 - 6 hours; 2018-07-05 to 2018-08-31 - hourly; 20

Length of Monitoring Record: 2016-12-09 to Current

Data available on BC Real-time Water

Data Website? Yes
Water Level Sensor: HOBO U20-001-01 (Range-9 m) replaced with HOBO MX2001-01 (Range 9m) on 2018-10-10.
Data Logger Type: HOBO U20 replaced with HOBO MX 2001 on 2018-10-10

Barometric Pressure Sensor: HOBO U20-001-04 replaced with HOBO MX2001 on 2018-10-10. (Both installed in airspace in well)

Water Level Sensor Depth (mbgs): 40 mbgs at installation, raised to 33.5 mbgs on 2016-12-09, lowered to 39.5 mbgs on 2018-07-05.

Comments: Well has never been used as a water supply. No pump is installed. Data gap due to water level dropping below water level sensor. Sensor has now been lowered.

Nearest climate station with a complete record

Climate Network Name: Environment Canada (Canadian Daily Climate Data)
Climate Station Location/Name: Nelson Rixen Creek
Climate Station Number: 1095

Aquifer Information

Aquifer #:	511
Aquifer Material:	Bedrock
Aquifer Area (km²):	23
Aquifer Confinement:	The aquifer is mostly confined, but shows windows in the confining layer, where the bedrock outcrops. (Aquifer Classification Worksheet).
Description¹:	Fractured crystalline (igneous intrusive or metamorphic, meta-sedimentary, metavolcanic, volcanic) rock aquifer (subtype =6b).
Likelihood of hydraulic connection¹:	Not likely (based on broad regional assessment)
Hydraulic Connection Assessment by LLC²:	Likely connected to Kootenay Lake
Rational for Hydraulic Connection Assessment by LLC³:	Fractured crystalline (igneous, intrusive, metamorphic) bedrock. Aquifer occurs within the Eagle Creek Plutonic Complex. The aquifer encompasses the minor unit of the Coryell Plutonic Rock. Confined mostly with unconfined windows. Shallow (0 m - 55.5 m). Flow direction is inferred to be towards the Northwest or the West Arm of the Kootenay Lake. Recharge occurs through direct precipitation and infiltration of surface water through fractures and cracks.

Foot Notes

¹From Provincial aquifer factsheets available at <https://apps.nrs.gov.bc.ca/gwells/aquifers>

²Assessed by Living Lakes Canada. See methods in report.

³Rational for hydraulic connectivity assessment by Living Lakes Canada.



GW SOLUTIONS
ASSESSMENT & PROTECTION OF GROUNDWATER



WELL ID:
LLC_VOW_03

EASTING: 467829
NORTHING: 5481112
DATE COMMENCED: 25 May, 2007
DATE COMPLETED: 25 May, 2007

LOCATION: Columbia Basin
CONTRACTOR: Thorman Drilling
STICK UP (m): 0.51

WELL ID PLATE No.: 17715
BC WELL TAG No.: 87879
DRILL RIG: Air rotary
DRILLER: Carl Mackenzie
LOGGED BY: Driller

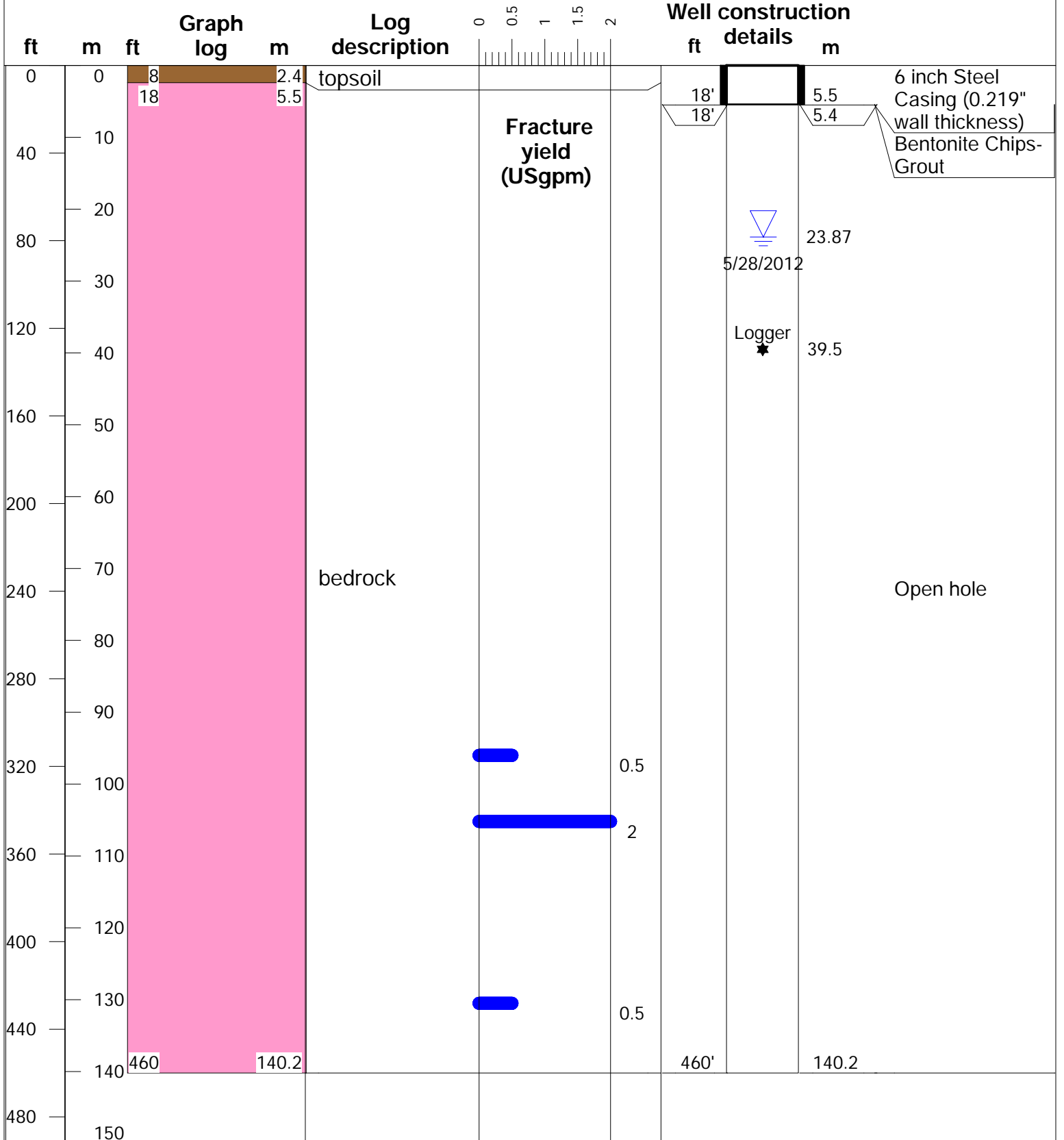

Water Level & Water Temperature Station ID: LLC_VOW_03

Station ID
LLC_VOW_03

Measurement Type
■ Logger dewatered
■ Manual data
■ Logger data

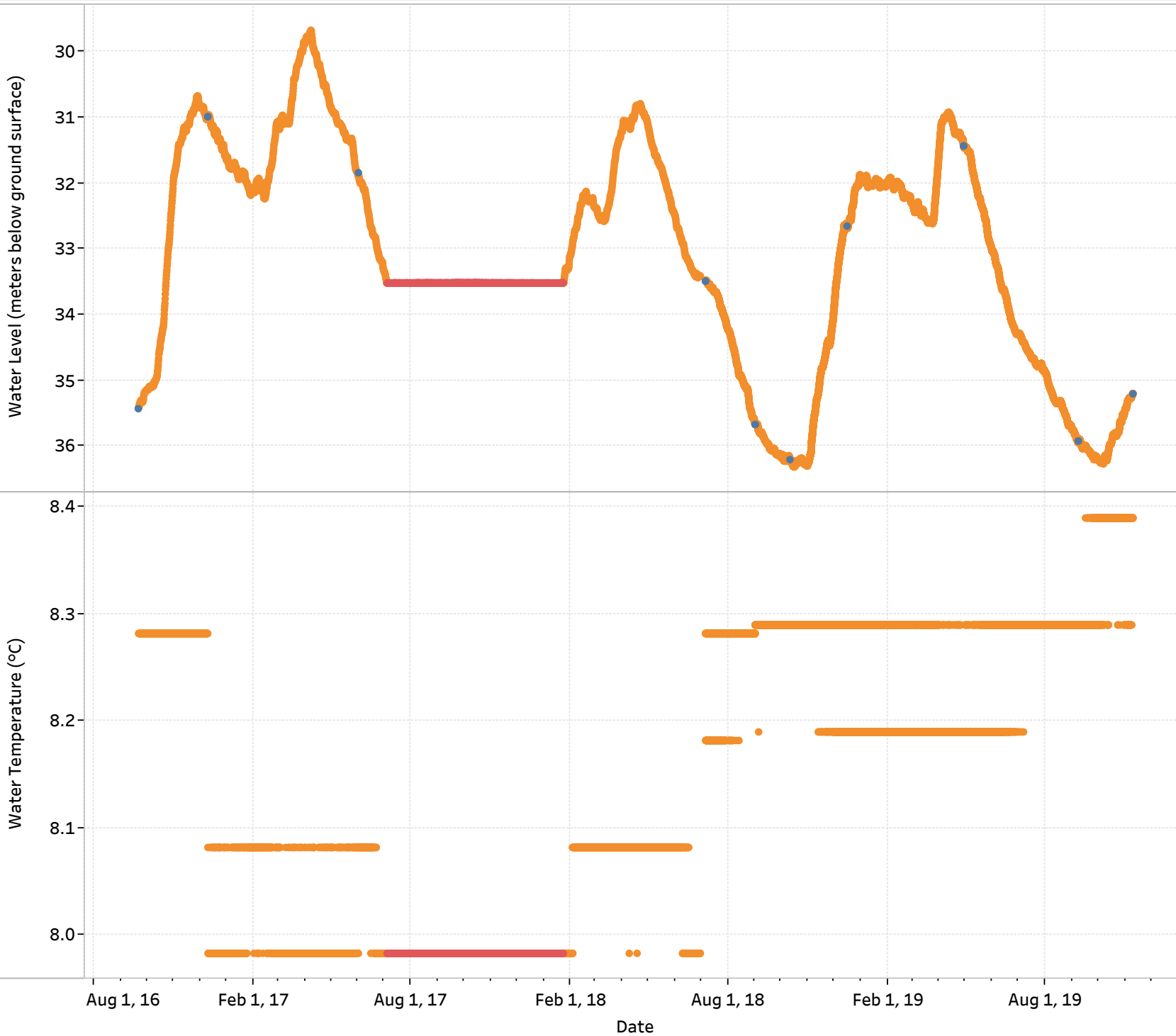

Well depth (mbgs)

140.2

Depth of Water Level Sensor (mbgs)

40 mbgs at installation, raised to 33.5 mbgs on 2016-12-09, lowered to 39.5 mbgs on 2018-07-05.



Graphs produced by:

C Waters Consulting



GW SOLUTIONS
ASSESSMENT & PROTECTION OF GROUNDWATER

Water Level & Daily Total Precipitation

Station ID: LLC_VOW_03

Station ID Groundwater
 LLC_VOW_03

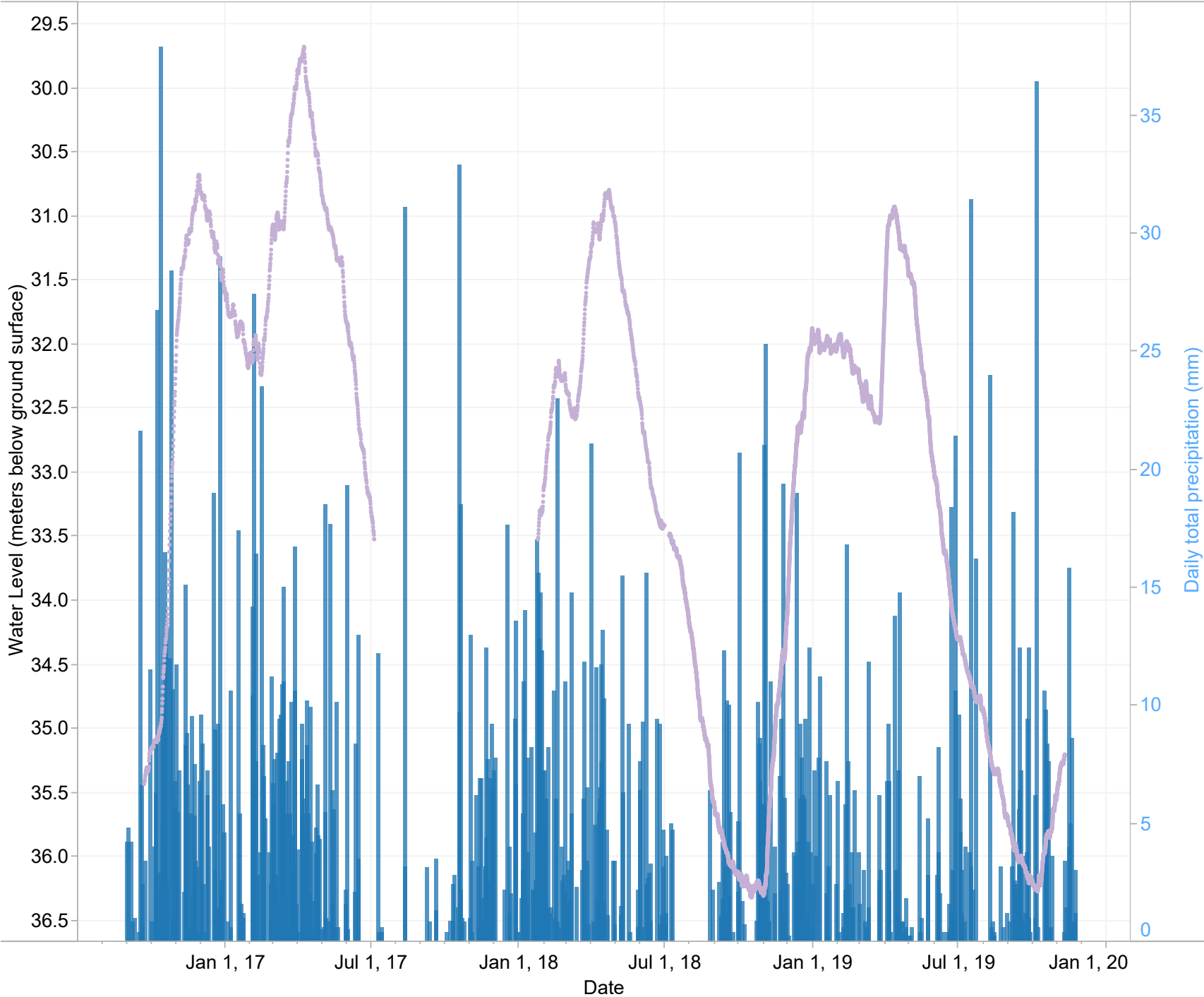

Station ID Legend

- 1095
- LLC_VOW_03

Precipitation	1095	NELSON RIXEN CREEK
Groundwater	LLC_VOW_03	Blewett, Carlson Road East.



Graphs produced by:

**C Waters
 Consulting**



GW SOLUTIONS
ASSESSMENT & PROTECTION OF GROUNDWATER

Water Level & Cumulative Precipitation Departure from Average (CPD)

Station ID: LLC_VOW_03

Station ID Groundwater
LLC_VOW_03

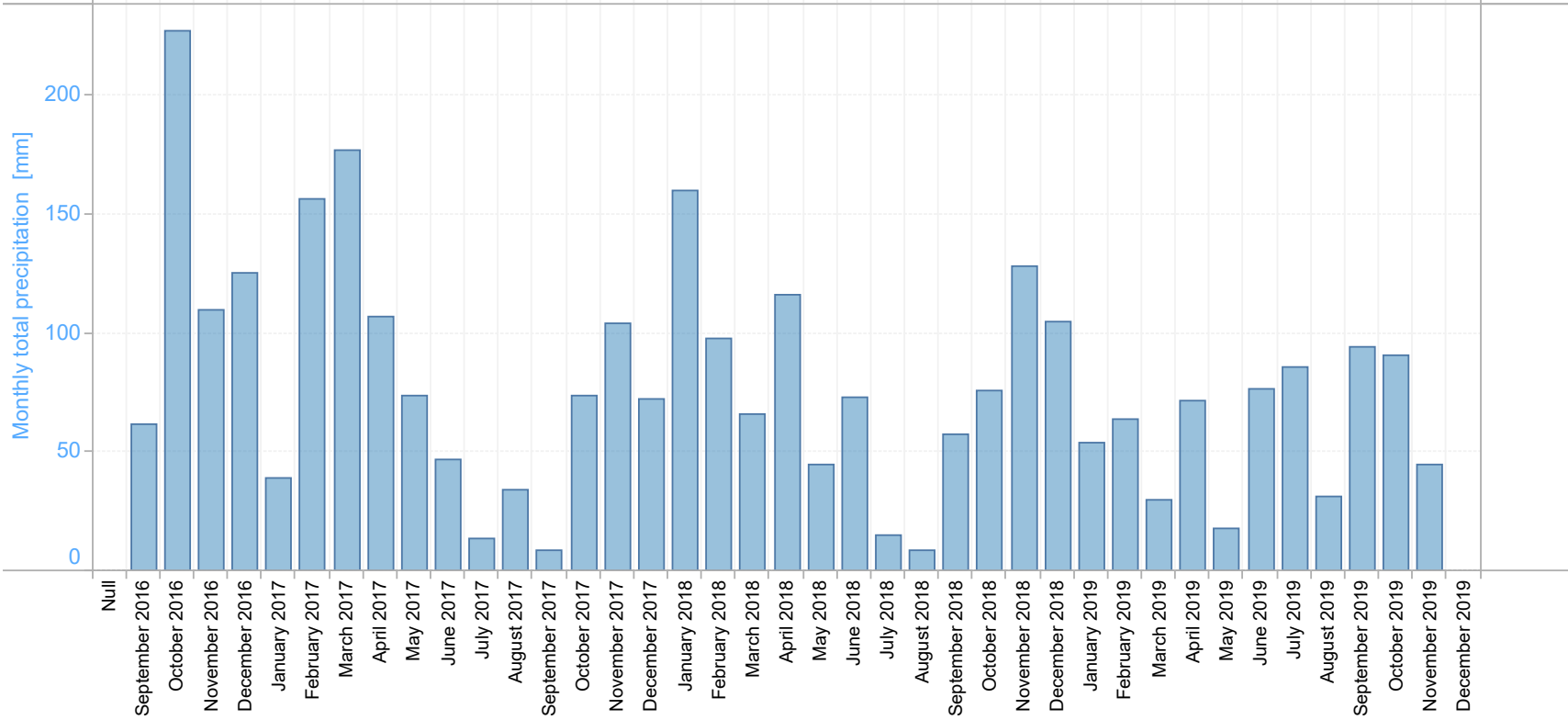
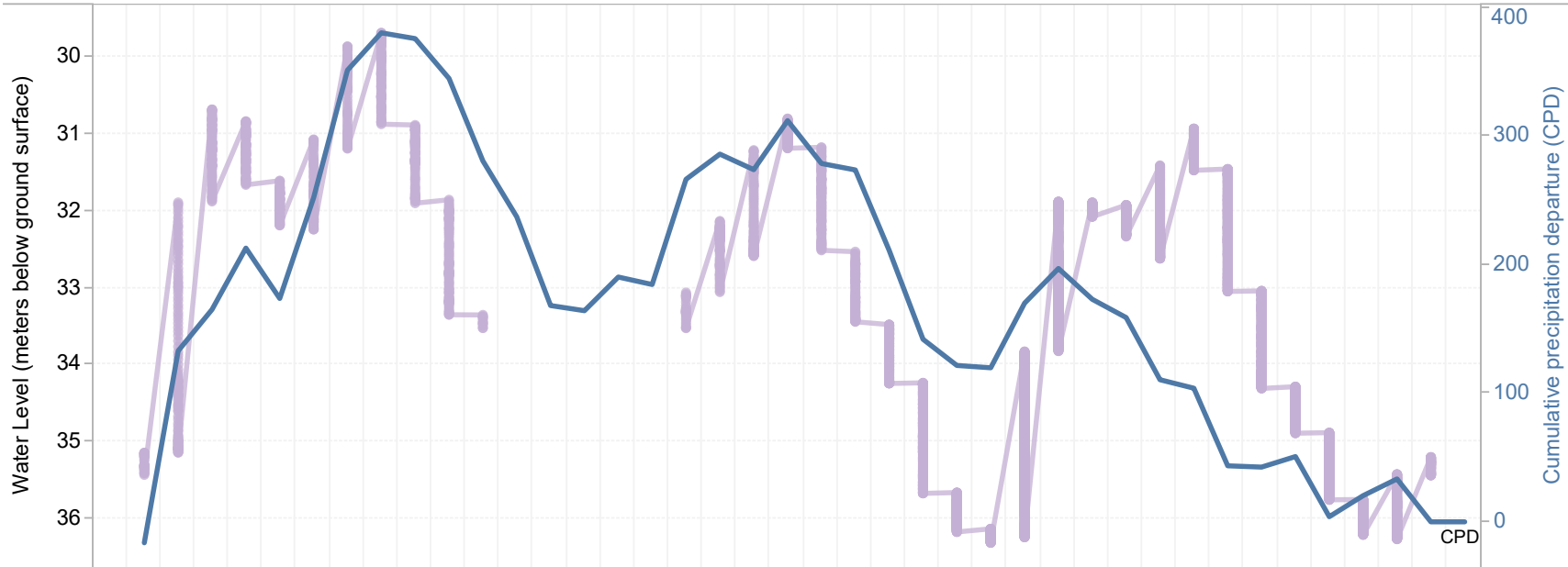

Graphs produced by:



Historical daily flow data for KOOTENAY RIVER ABOVE CORRA LINN & LLC_VOW_03 (All)

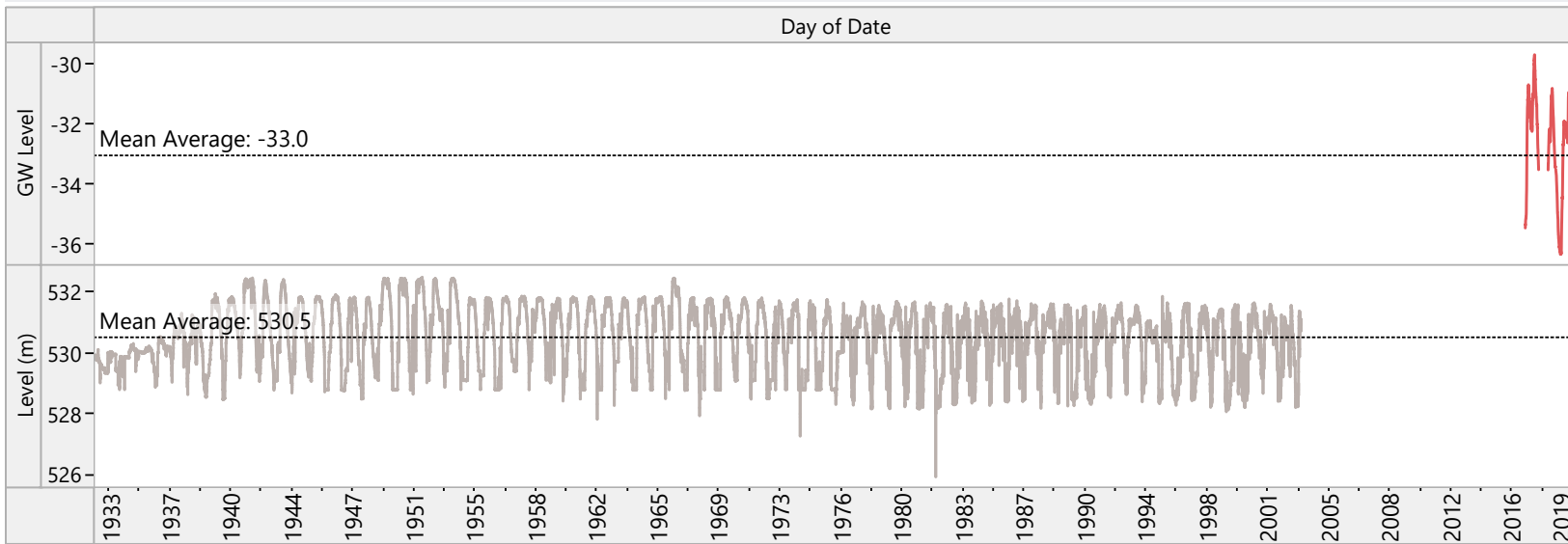

Parameter
Multiple values

Station Status
● ACTIVE
▼ DISCONTINUED

Station ID
■ 08NJ113
■ LLC_VOW_03

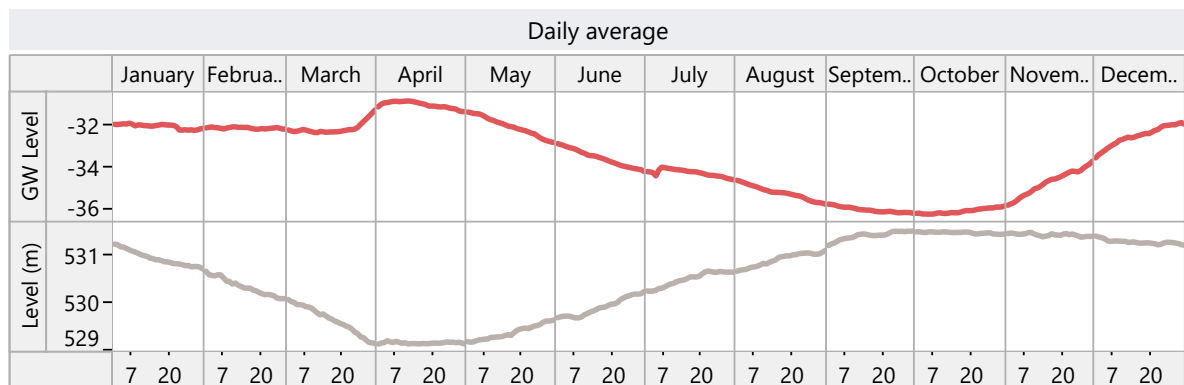
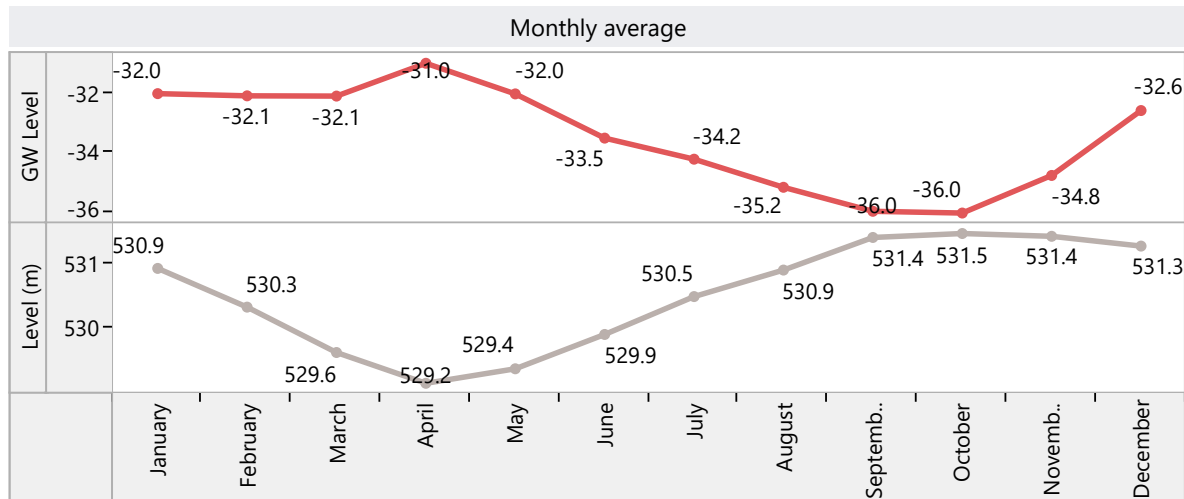

Water Level Yearly Comparison LLC_VOW_03

Station ID
LLC_VOW_03

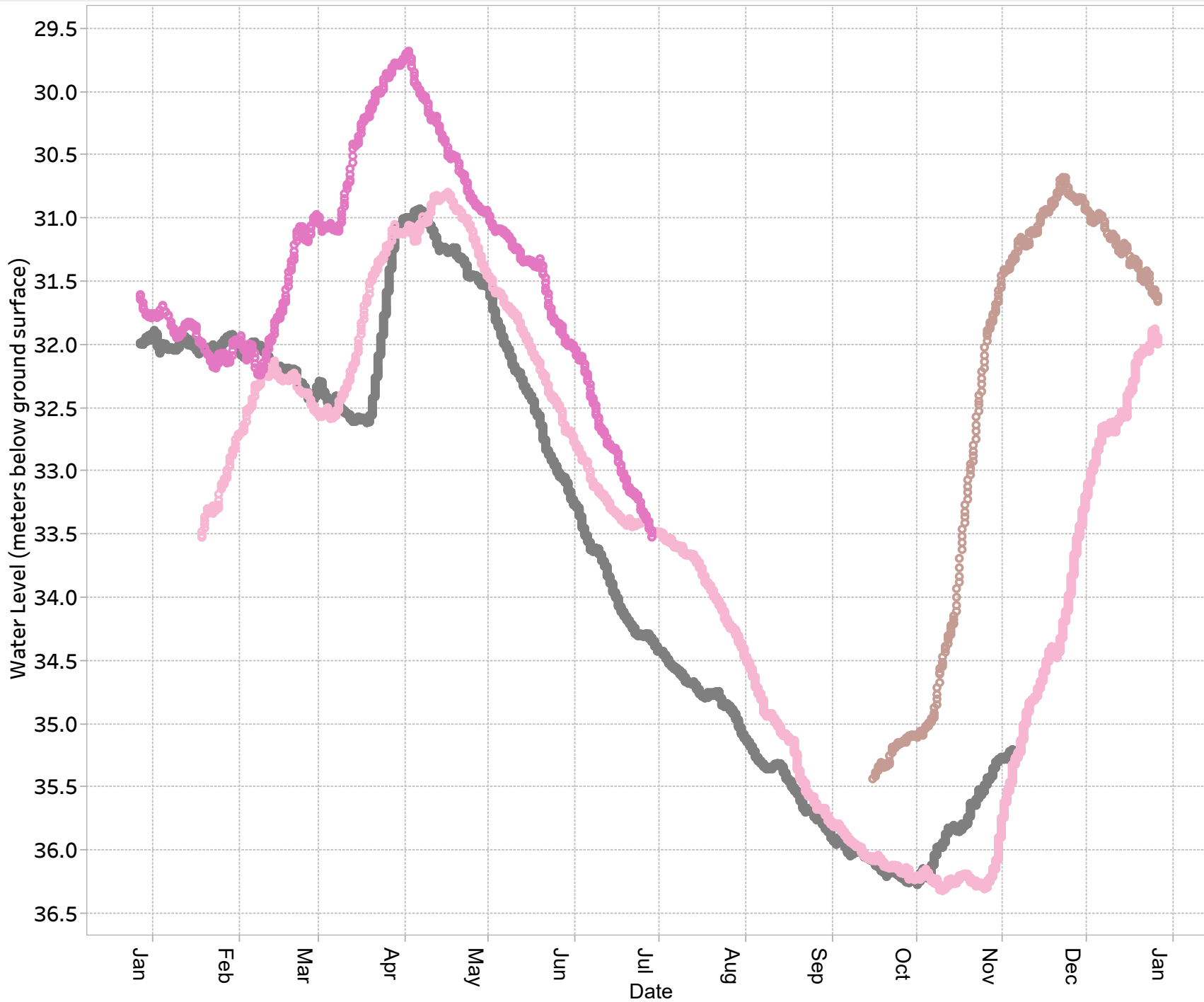

YEAR

- 2016
- 2017
- 2018
- 2019



Graphs produced by:



Monitoring Locations: VOW_04 - Castlegar; VOW_05 - South East Castlegar

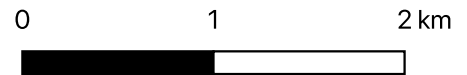

Legend

Living Lakes Canada

Volunteer Observation Well (VOW)

- Active

Provincial Groundwater Observation Well (OW)

- Active

Provincially Mapped Aquifers

- Bedrock Aquifer
- Sand & Gravel Aquifer

Wells registered in GWELLS

- Well Decommissioned
- Well assigned to a Mapped Aquifer
- Well not assigned to a Mapped Aquifer

Environmental Monitoring System

Groundwater Sampling

- Spring or Hot Spring
- Well
- Monitoring Well
- Contaminated Site
- Observation Well

Climate Station

- ◆ Environment and Climate Change Canada

Data Sources

- BC Data Catalogue (Groundwater Aquifers, Jun 4 2019; GWELLS, May 9 2019; Environmental Monitoring System, May 29 2019; BC Geographical Names, Dec 13 2019)
- Pacific Climate Impacts Consortium (BC Station Data, Nov 29 2019)
- Google Satellite

Coordinate Reference System: WGS 84 / UTM Zone 11N (EPSG: 32611)

Well Station ID: LLC_VOW_04

Location Description: Castlegar, Near 13th Ave & Columbia Ave.

Reason for monitoring: Aquifer 505 identified as priority for monitoring in 2009 PGOWN Review and suggested by FLNRORD.

Well Information

Well Tag Number:	23702	Well ID # from owner:	North Well/ Production
Well Plate ID:	16671		Well 3
Well Stick up (m):	0.1	EMS #	1401512
Well Depth (m):	38.4	Latitude:	49.324823
Well Casing:	Municipal Water Supply Well	Longitude:	-117.667222
		Source of Location	
Top of Screen (mbgs):	27.43/ 36.58 (two screen intervals)	Coordinates:	
Bottom of Screen (mbgs):	30.48/ 37.80 (two screen intervals)		Handheld GPS
Confining Layers:	None- all sand, gravel, till; bedrock at 38.40 mbgs		
Initial Well Use/Reason for well construction:	Water system supply well for domestic purposes.		

Monitoring Information

Monitoring Status: Active

Monitoring Interval: 5 minutes up to 2019-04-09 13:40; 10 minutes thereafter

Length of Monitoring Record: 2016-11-29 to Current

Data available on BC Real-time Water Data Website? Yes

Water Level Sensor: Keller Acculevel High Accuracy Submersible Level Transmitter, Range- 40 ft.

Data Logger Type: Keller/Campbell Scientific

Barometric Pressure Sensor: N/A - Pressure transducer vented to atmosphere.

Water Level Sensor Depth (mbgs): 26.1; assumed 29.9 mbgs from 2018-06-14 to 2018-12-15, repositioned to 26.14 mbgs on 2019-04-09

Comments: This well is an inactive water supply well. Pump is activated approximately monthly to test pump. After pumping, water levels return to static water levels quickly. Water levels influenced by pumping have been removed from the data set in the interpretive graphs in this report. The data gaps are associated with times data were removed due to pumping and problems with the data logger. All measurements are based on the initial manual water level reading at the time of installation of the pressure transducer. No manual water level measurements were collected after initial installation. Pressure transducer slipped on 2018-06-14. Data from 2018-06-14 to 2018-12-15 was corrected for slippage by assuming the transducer slipped 3.8 m. In April 2019, transducer was repositioned to 26.14 mbgs. No water level measurements were collected when the transducer was repositioned. Data from 2019-04-09 to 2019-10-02 assumes transducer is at 26.14 mbgs. No water temperature data collected.

Nearest climate station with a complete record

Climate Network Name: Environment Canada (Canadian Daily Climate Data)

Climate Station Location/Name: Castlegar A

Climate Station Number: 1105

Aquifer Information

Aquifer #:	505
Aquifer Material:	Sand and gravel
Aquifer Area (km²):	1.9
Aquifer Confinement:	Partially confined
Description¹:	Confined glacio-fluvial sand and gravel aquifers underneath till, in between till layers, or underlying glacio-lacustrine deposits (subtype = 4b).
Likelihood of hydraulic connection¹:	Not likely (based on broad regional assessment)
Hydraulic Connection Assessment by LLC²:	Likely connected to the Columbia River
Rational for Hydraulic Connection Assessment by LLC³:	The aquifer boundary follows the shoreline of the Columbia River (460 m elevation). The partially confined aquifer has overlaying lithology of interlayered sands and gravels with till and silt/clay. Groundwater flow likely follows the topographic gradient (high elevation to low elevation) towards the Columbia River. Recharge is likely from precipitation as well as the Columbia River.

Foot Notes

¹From Provincial aquifer factsheets available at <https://apps.nrs.gov.bc.ca/gwells/aquifers>

²Assessed by Living Lakes Canada. See methods in report.

³Rational for hydraulic connectivity assessment by Living Lakes Canada.



GW SOLUTIONS
ASSESSMENT & PROTECTION OF GROUNDWATER



WELL ID:
LLC_VOW_04

EASTING: 451516

NORTHING: 5463780

DATE COMMENCED: July 1970 (day unknown)

DATE COMPLETED: July 1970 (day unknown)

LOCATION: Columbia Basin

CONTRACTOR:

STICK UP (m): 0.00

WELL ID PLATE No.:

BC WELL TAG No.: 109719/23702

DRILL RIG:

DRILLER: W.L. Brown

LOGGED BY: Driller/Hydrogeologic

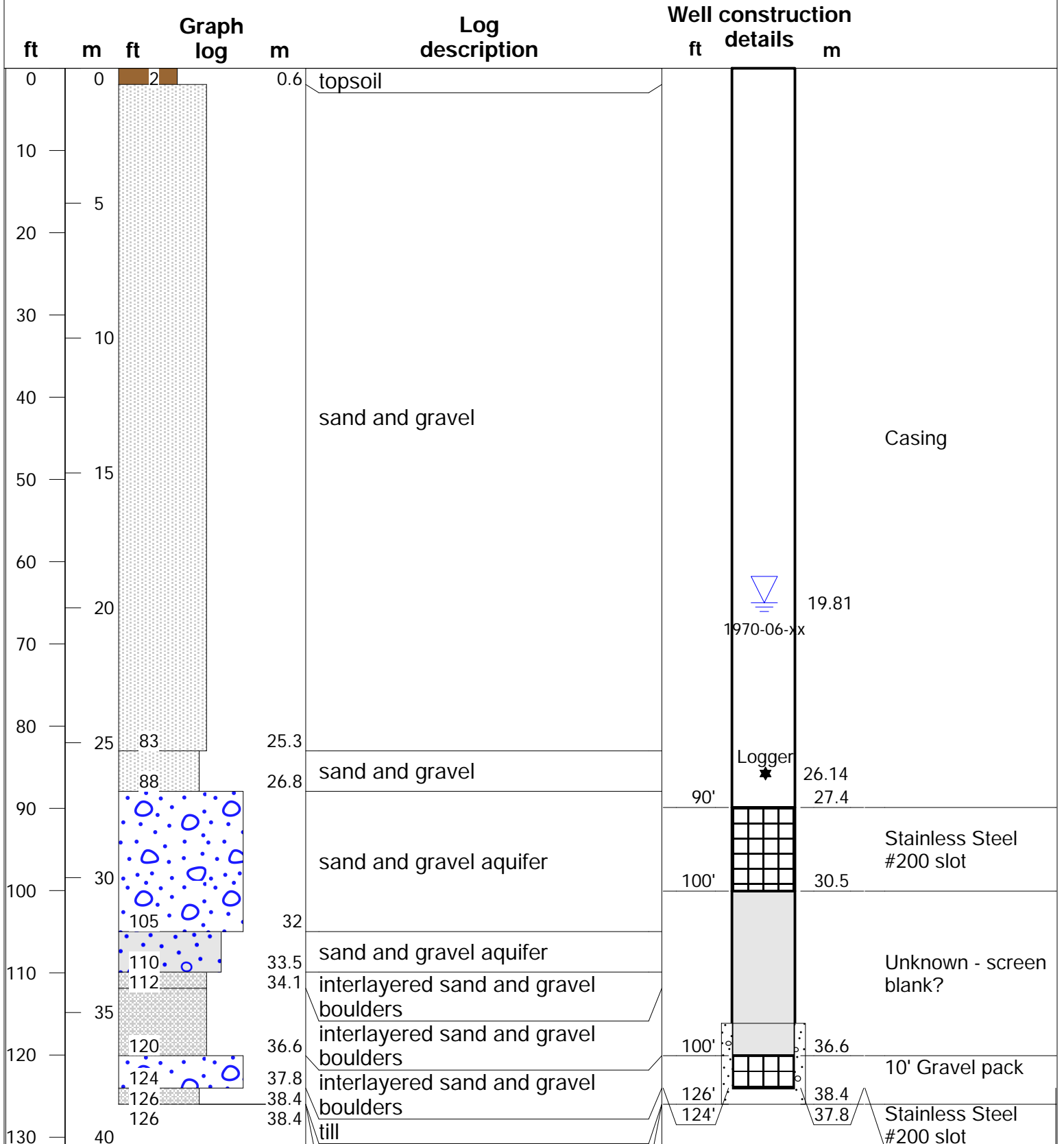

Water Level & Water Temperature Station ID: LLC_VOW_04

Station ID
LLC_VOW_04

Measurement Type

- Pumping effect
- Outlier
- Logger data

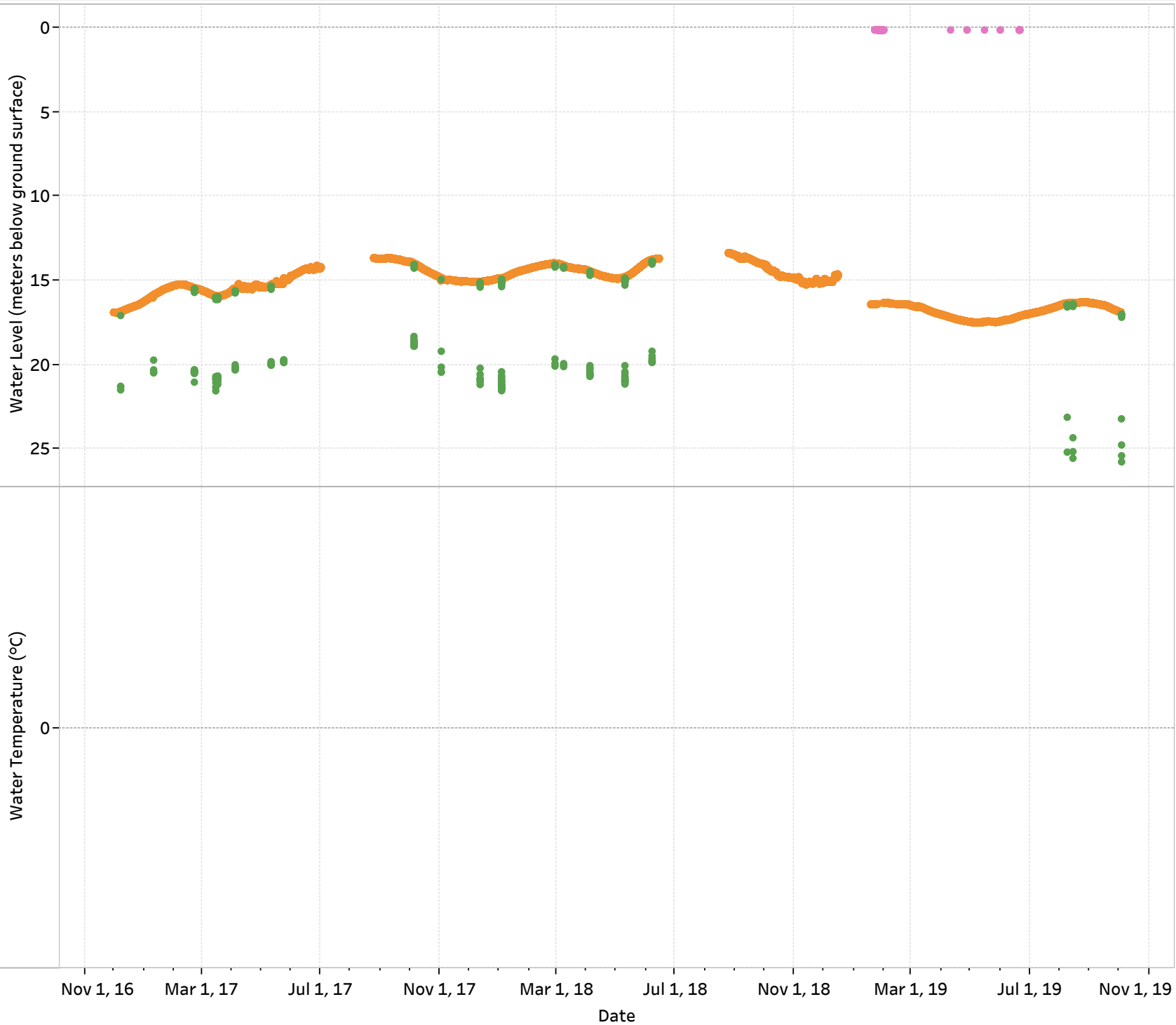

Well depth (mbsg)

38.4

Depth of Water Level
Sensor (mbsg)

26.1 mbsg (85'9" bgs.
From schematic)



Graphs produced by:

C Waters
Consulting



GW SOLUTIONS
ASSESSMENT & PROTECTION OF GROUNDWATER

Water Level & Daily Total Precipitation

Station ID: LLC_VOW_04

Station ID Groundwater
 LLC_VOW_04

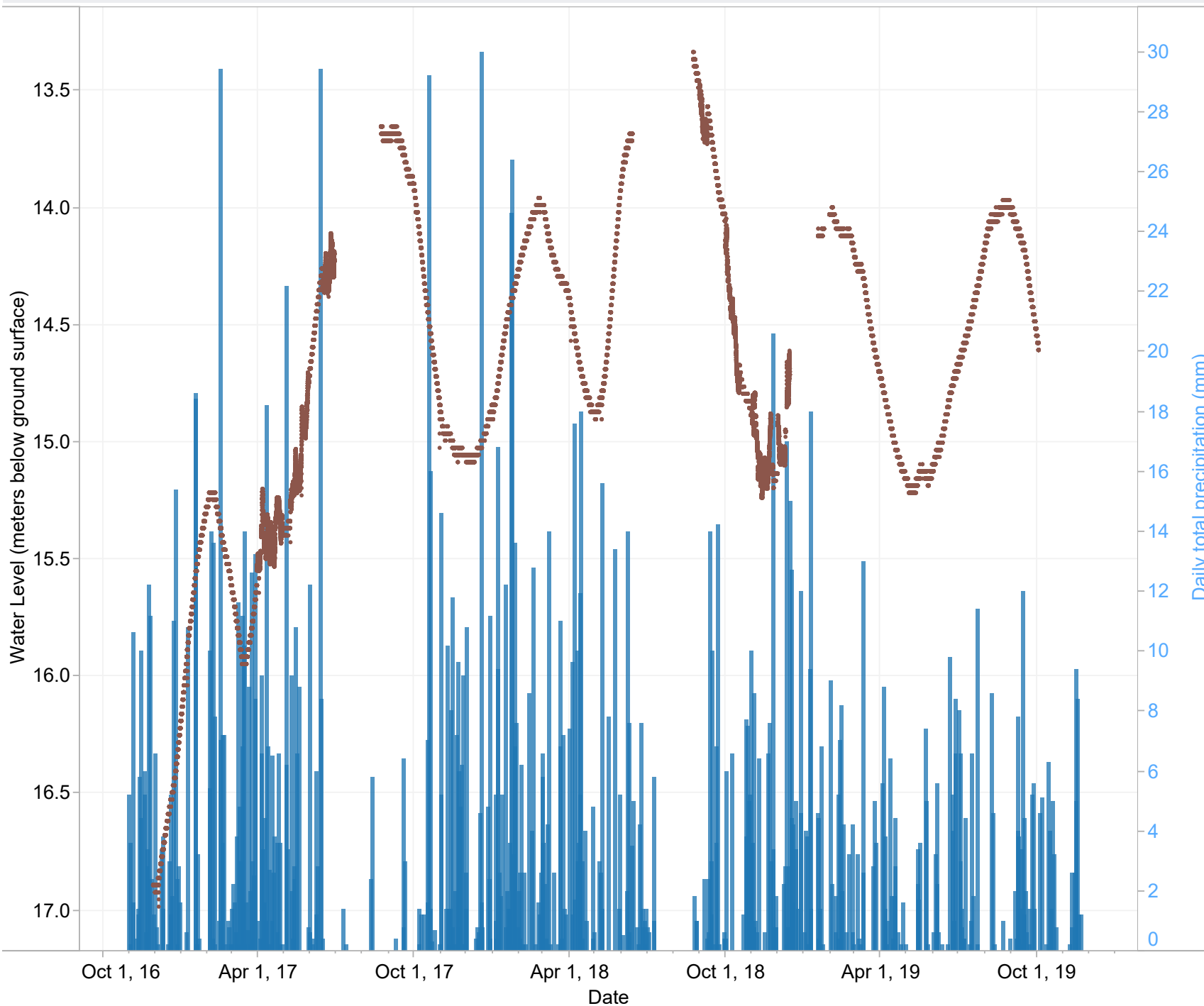

Station ID Legend
■ 1105
■ LLC_VOW_04

Precipitation	1105	CASTLEGAR ▲
Groundwater	LLC_VOW_04	Castlegar, Near 13th Ave & Columbia Ave.



Graphs produced by:

C Waters
 Consulting



GW SOLUTIONS
ASSESSMENT & PROTECTION OF GROUNDWATER

Water Level & Cumulative Precipitation Departure from Average (CPD)

Station ID: LLC_VOW_04

Station ID Groundwater
LLC_VOW_04

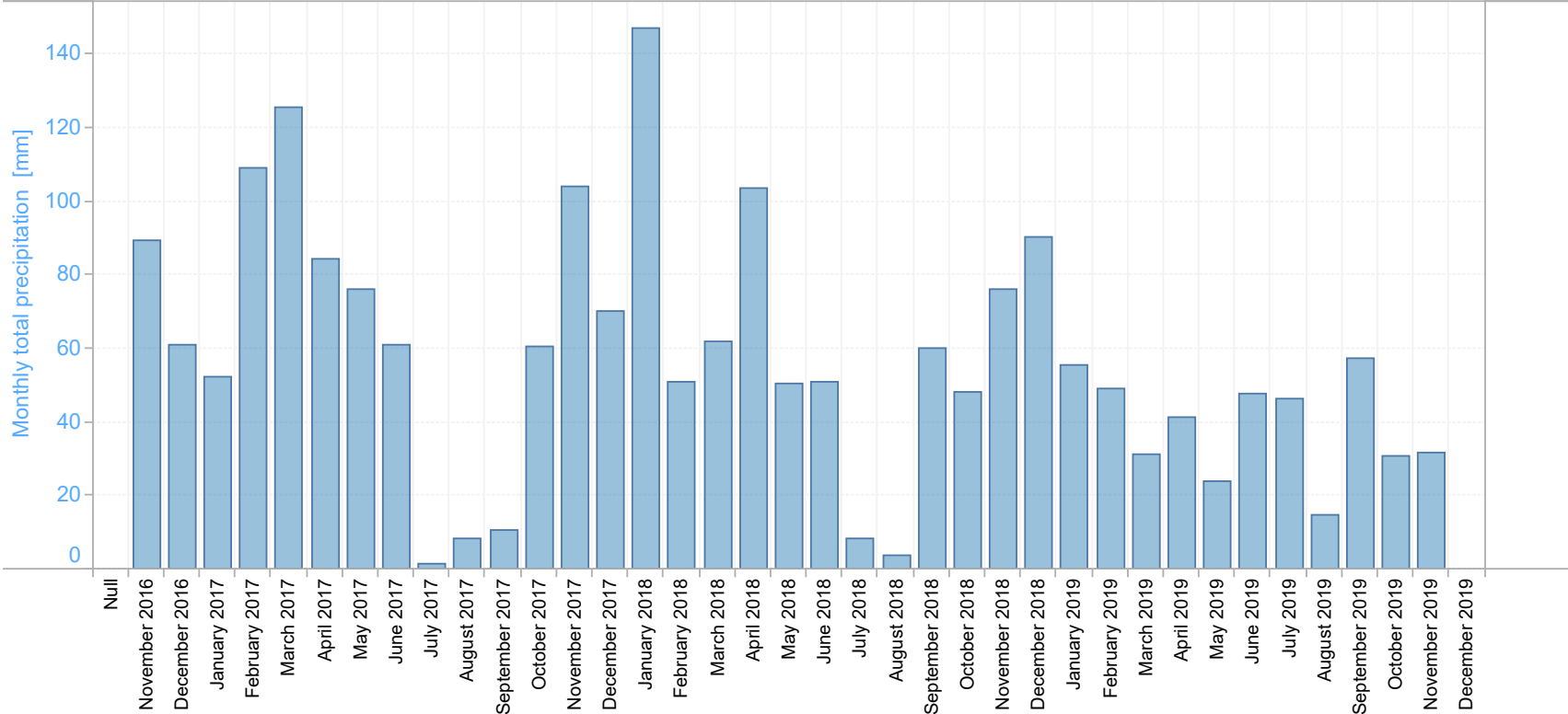
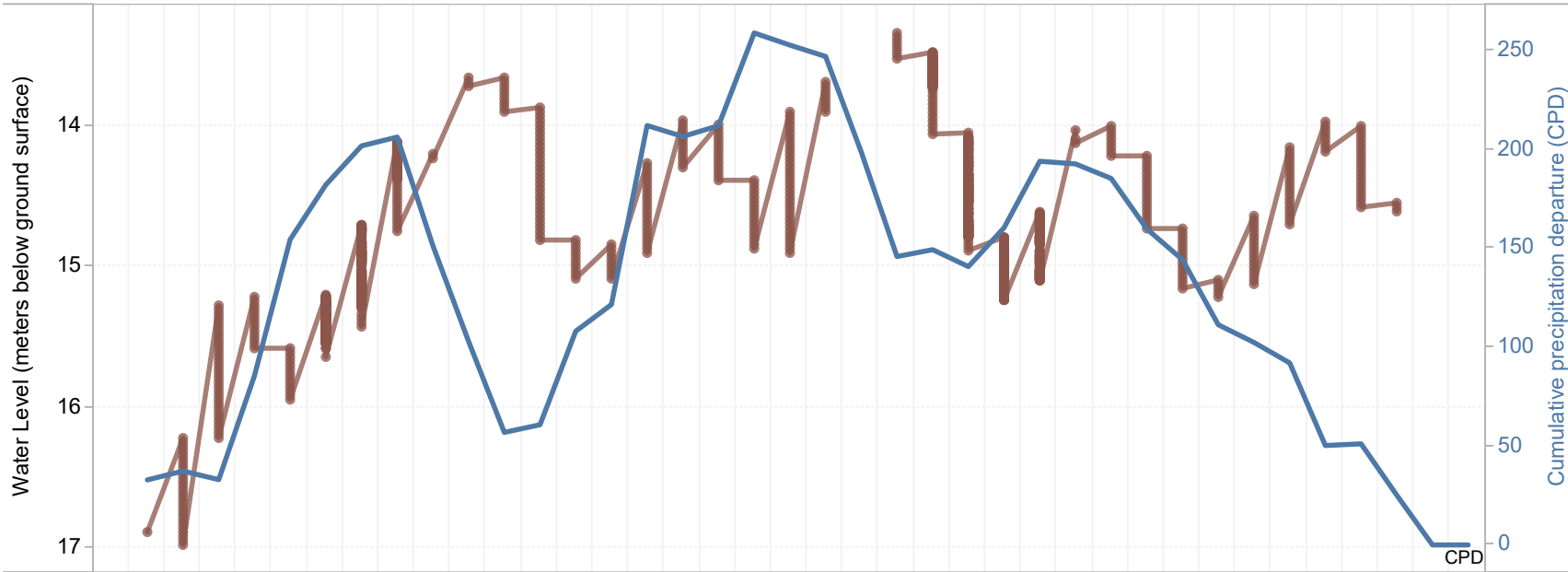

Graphs produced by:



Historical daily flow data for COLUMBIA RIVER AT BIRCHBANK & LLC_VOW_04 (All)

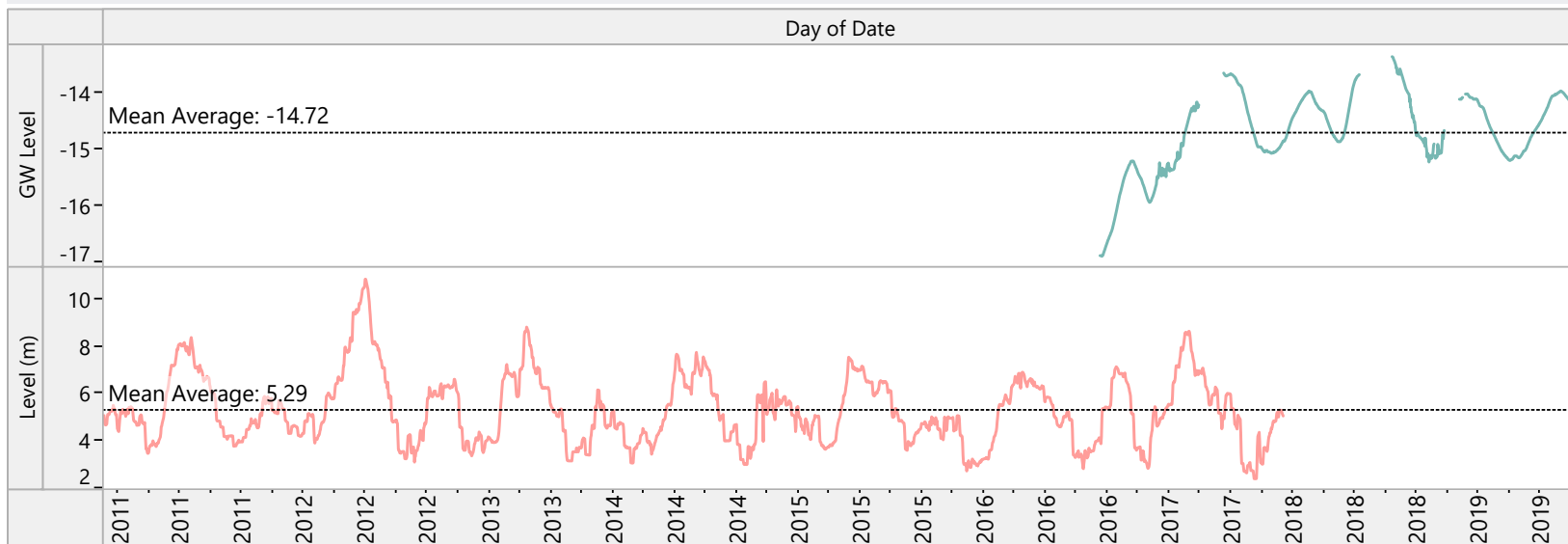

Parameter
Multiple values

Station Status
● ACTIVE
▼ DISCONTINUED

Station ID
■ 08NE049
■ LLC_VOW_04

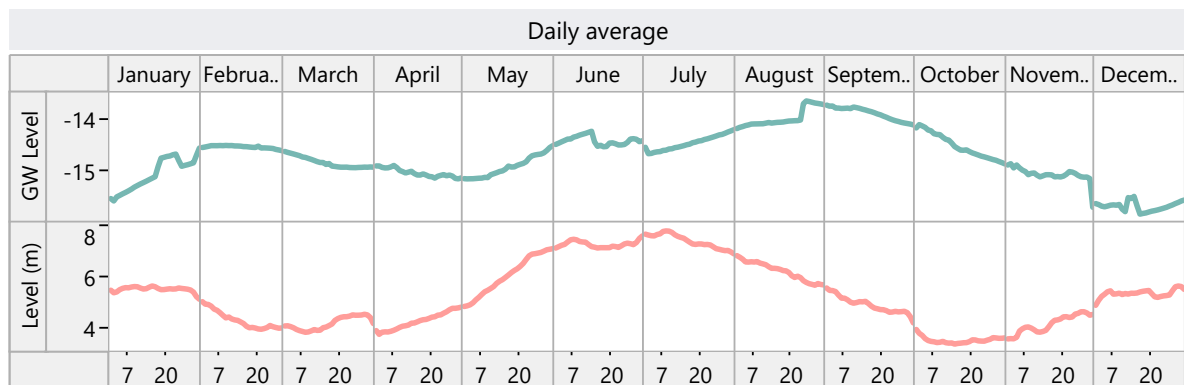
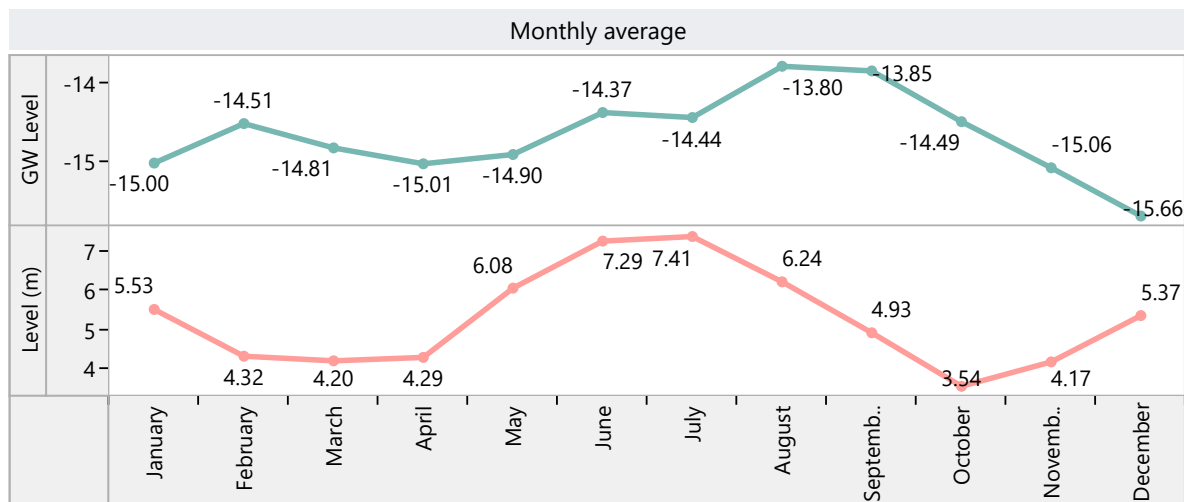
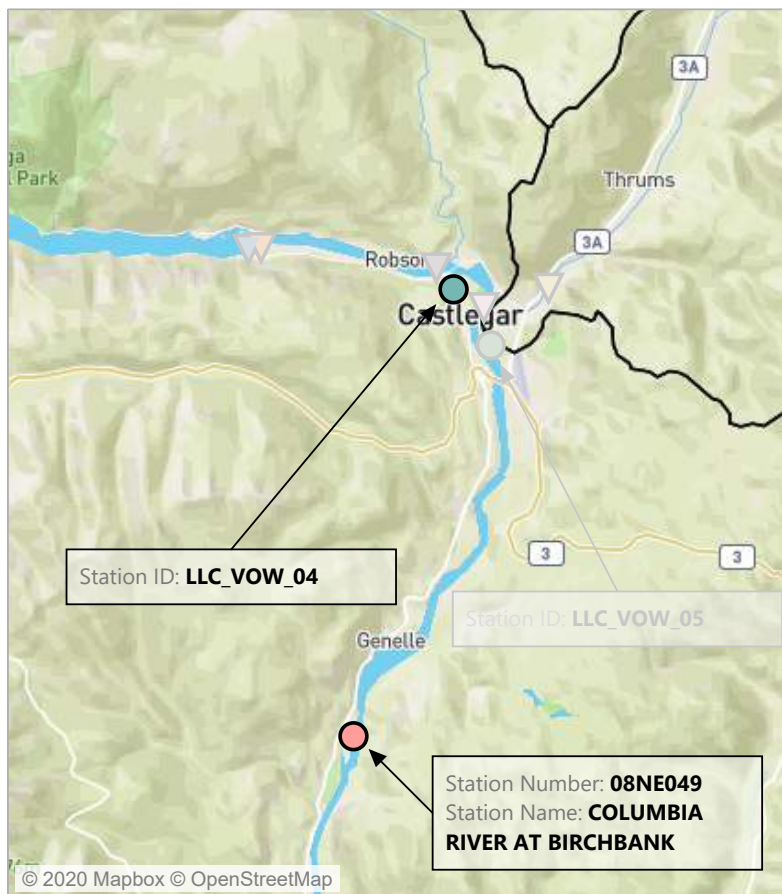

Water Level Yearly Comparison LLC_VOW_04

Station ID
LLC_VOW_04

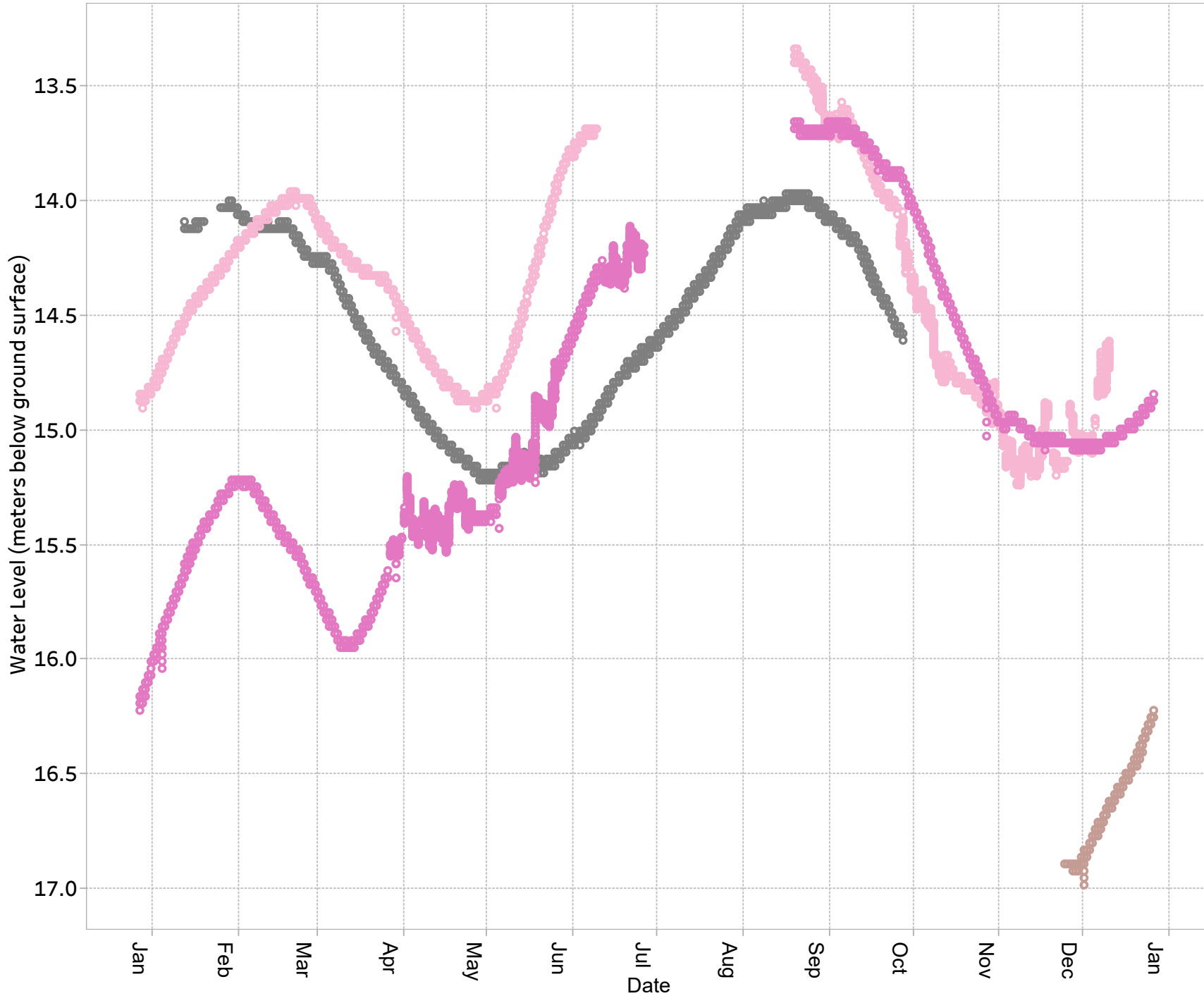

YEAR
2016
2017
2018
2019



Graphs produced by:



Well Station ID: LLC_VOW_05

Location Description: Southeast of Castlegar, downstream of Kootenay and Columbia River confluence.

Reason for monitoring: Aquifer 487 identified as priority for monitoring in 2009 PGOWN Review and suggested by FLNRORD.

Well Information

Well Tag Number:	None	Well ID # from owner:	n/a
Well Plate ID:	None, not registered in database		
Well Stick up (m):	0	EMS #	n/a
Well Depth (m):	14.1	Latitude:	49.3064
Well Casing:	12.5" well casing installed 2.4 m below ground surface. Well located in old shed.	Longitude:	-117.648505
Top of Screen (mbgs):	None	Source of Location Coordinates:	
Bottom of Screen (mbgs):	None		Handheld GPS
Confining Layers:	Unknown. No well construction or lithology information.		
Initial Well Use/Reason for well construction:	Historic well, likely built by Dukabors		

Monitoring Information

Monitoring Status: Active

Monitoring Interval: 2017-03-02 to 2017-10-14 - 15 minutes; 2018-03-07- current- Hourly

Length of Monitoring Record: 2017-03-02 to Current

Data available on BC Real-time Water Data Website? No

Water Level Sensor: HOB0 U20-001-02 (Range - 30.5m)

Data Logger Type: HOB0 U20

Barometric Pressure Sensor: HOB0 U20-001-04/ installed in airspace in well

Water Level Sensor Depth (mbgs): 12.9

Comments: Well does not meet the Groundwater Protection Regulations. Requires upgrades or decommissioning. Data gaps associated with setting up the data logger.

Nearest climate station with a complete record

Climate Network Name: Environment Canada (Canadian Daily Climate Data)

Climate Station Location/Name: Castlegar A

Climate Station Number: 1105

Aquifer Information

Aquifer #:	508
Aquifer Material:	Sand and gravel
Aquifer Area (km²):	1.4
Aquifer Confinement:	Partially confined
Description¹:	Confined glacio-fluvial sand and gravel aquifers underneath till, in between till layers, or underlying glacio-lacustrine deposits (subtype = 4b).
Likelihood of hydraulic connection¹:	Not likely (based on broad regional assessment)
Hydraulic Connection Assessment by LLC²:	Likely connected to the Kootenay and Columbia Rivers
Rational for Hydraulic Connection Assessment by LLC³:	Aquifer boundaries follow the shoreline of the Columbia and Kootenay River, or the break in slope along the 440 masL contour. Characterised as an aquifer found along rivers of moderate stream order with the potential to be hydraulically influenced by the river. Hydraulically connected to the Kootenay and Columbia Rivers.

Foot Notes

¹From Provincial aquifer factsheets available at <https://apps.nrs.gov.bc.ca/gwells/aquifers>

²Assessed by Living Lakes Canada. See methods in report.

³Rational for hydraulic connectivity assessment by Living Lakes Canada.

Water Level & Water Temperature Station ID: LLC_VOW_05

Station ID
LLC_VOW_05

Measurement Type

- Manual data
- Logger data

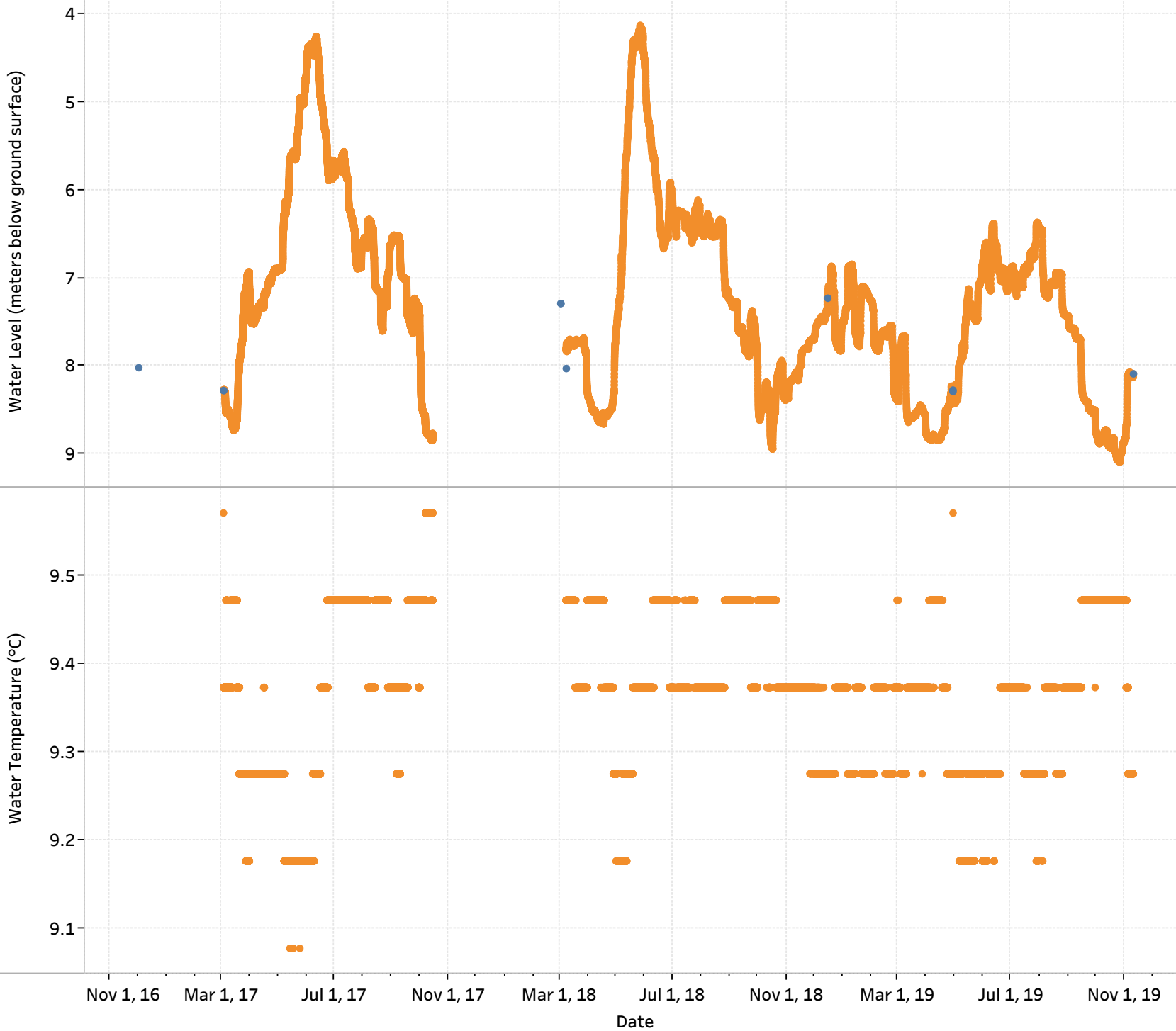

Well depth (mbgs)

14.1

Depth of Water Level Sensor (mbgs)

12.9 mbgs (Well casing is in pit, 2.4 m below the ground)



Graphs produced by:



GW SOLUTIONS
ASSESSMENT & PROTECTION OF GROUNDWATER

Water Level & Daily Total Precipitation

Station ID: LLC_VOW_05

Station ID Groundwater
LLC_VOW_05

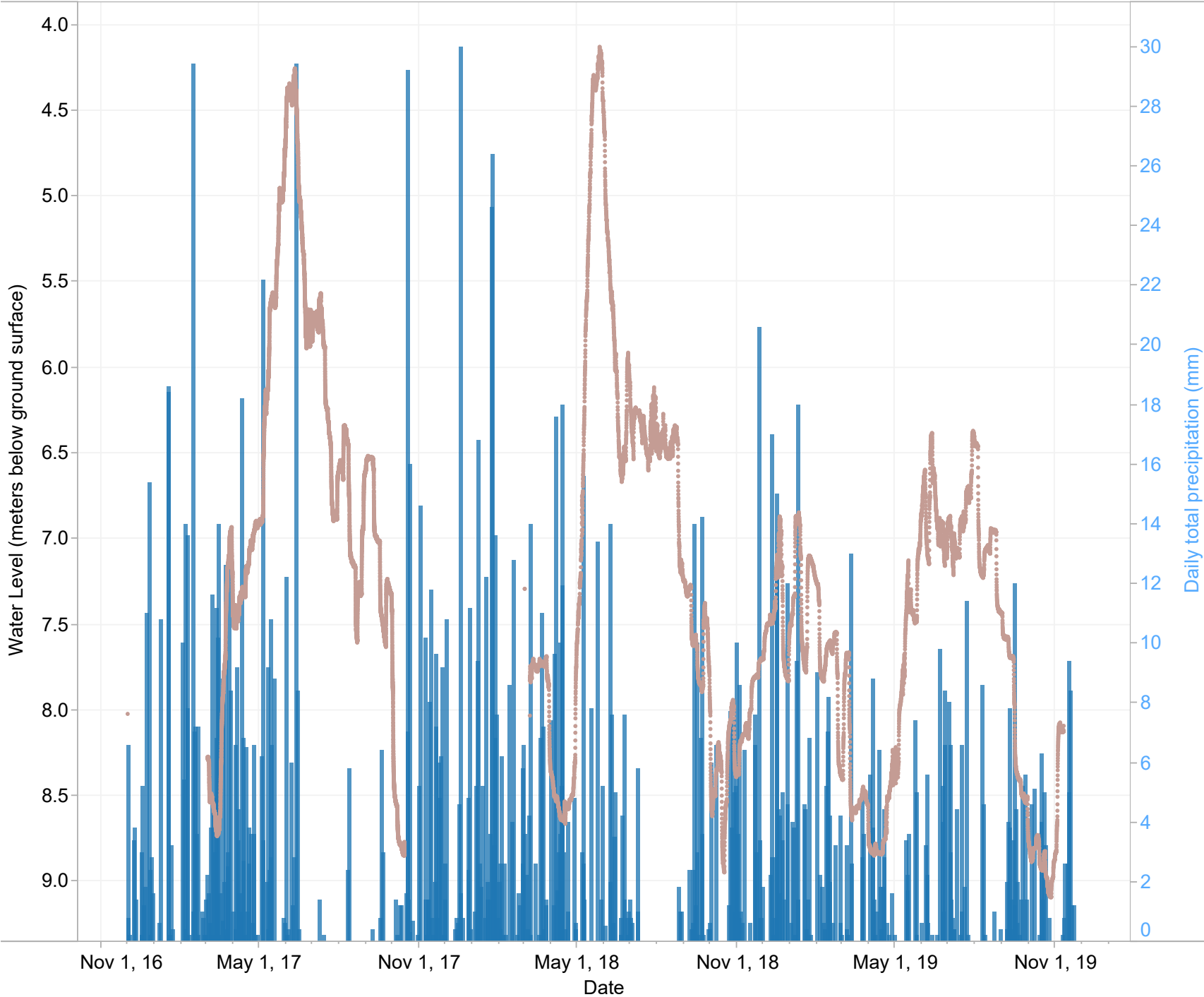

Station ID Legend

- 1105
- LLC_VOW_05

Precipitation	1105	CASTLEGAR A
Groundwater	LLC_VOW_05	Southeast of Castlegar, downstream of Kootenay and Columbia River confluence.



Graphs produced by:

C Waters
Consulting



GW SOLUTIONS
ASSESSMENT & PROTECTION OF GROUNDWATER

Water Level & Cumulative Precipitation Departure from Average (CPD)

Station ID: LLC_VOW_05

Station ID Groundwater
LLC_VOW_05

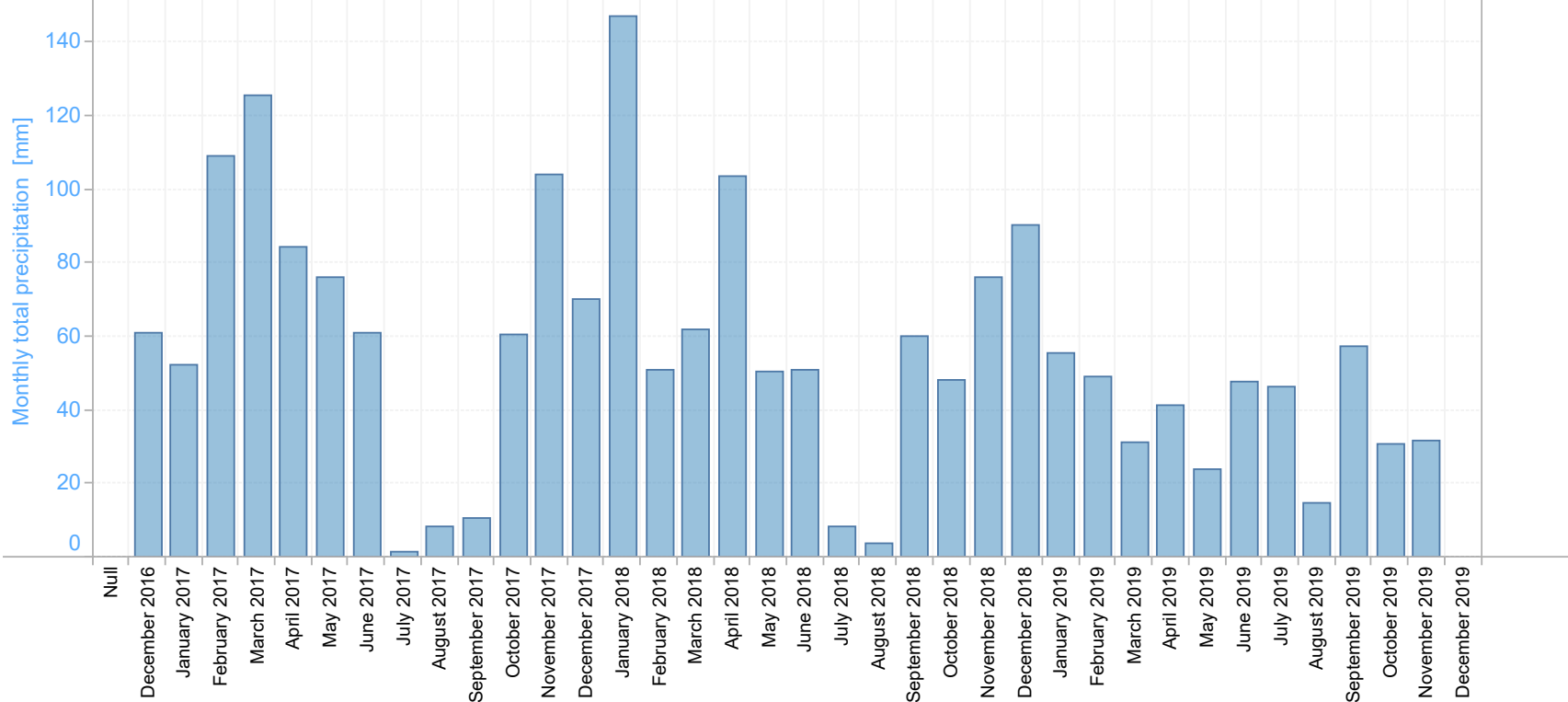
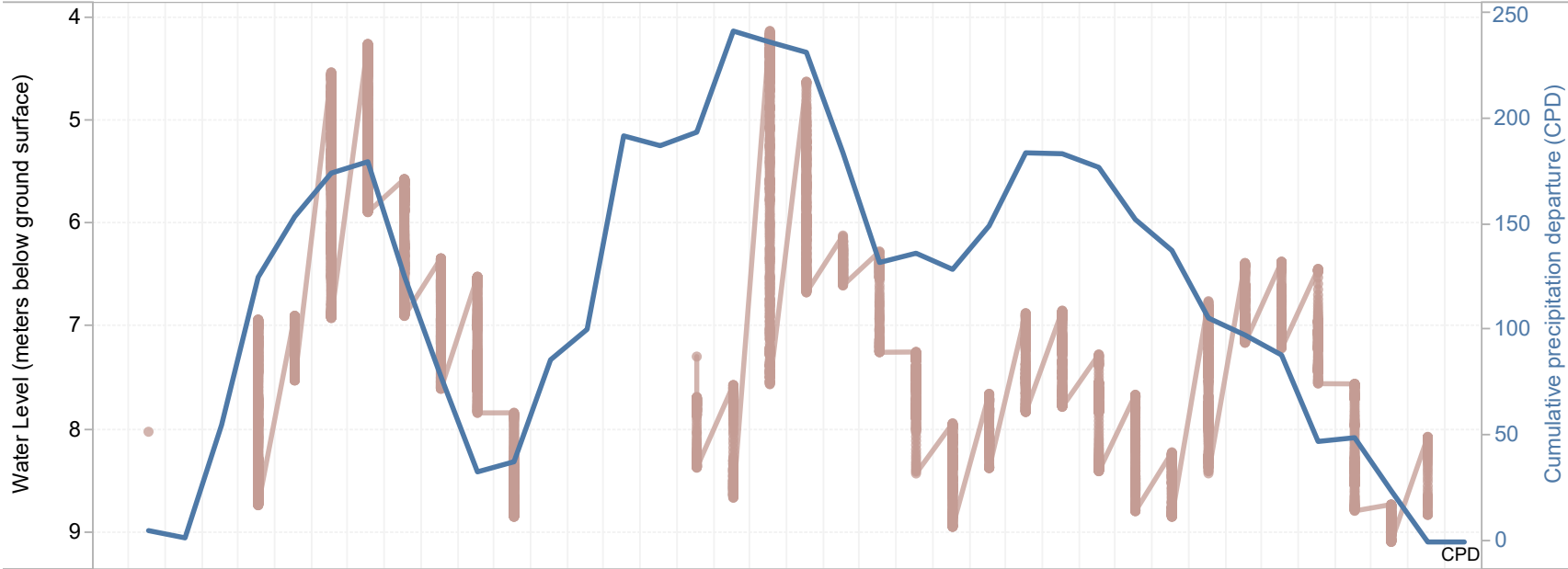

Graphs produced by:



Historical daily flow data for COLUMBIA RIVER AT BIRCHBANK & LLC_VOW_05 (All)

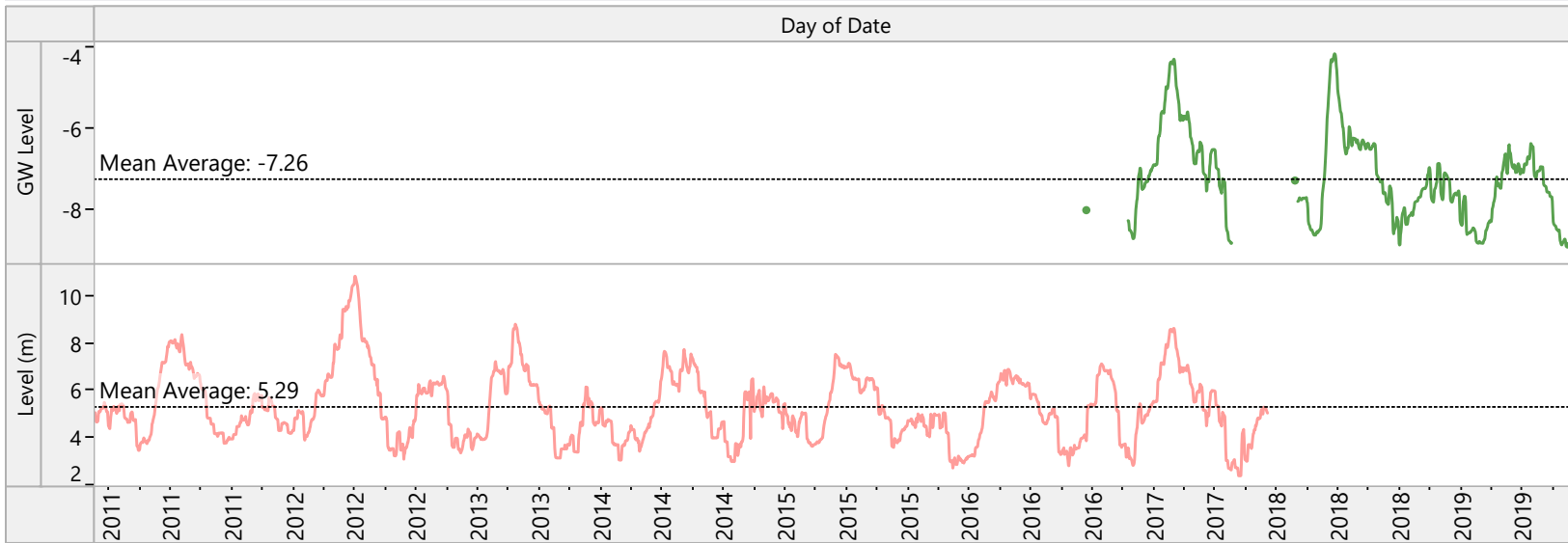

Parameter
Multiple values

Station Status
● ACTIVE
▼ DISCONTINUED

Station ID
08NE049
LLC_VOW_05

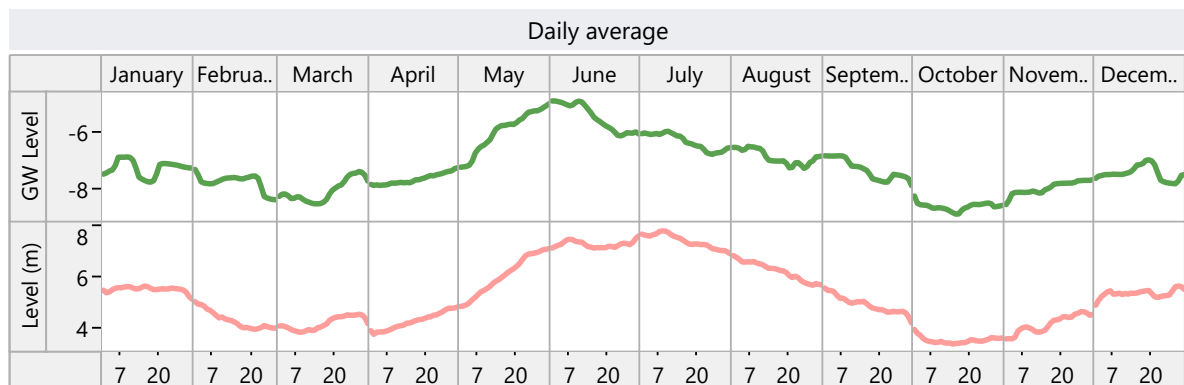
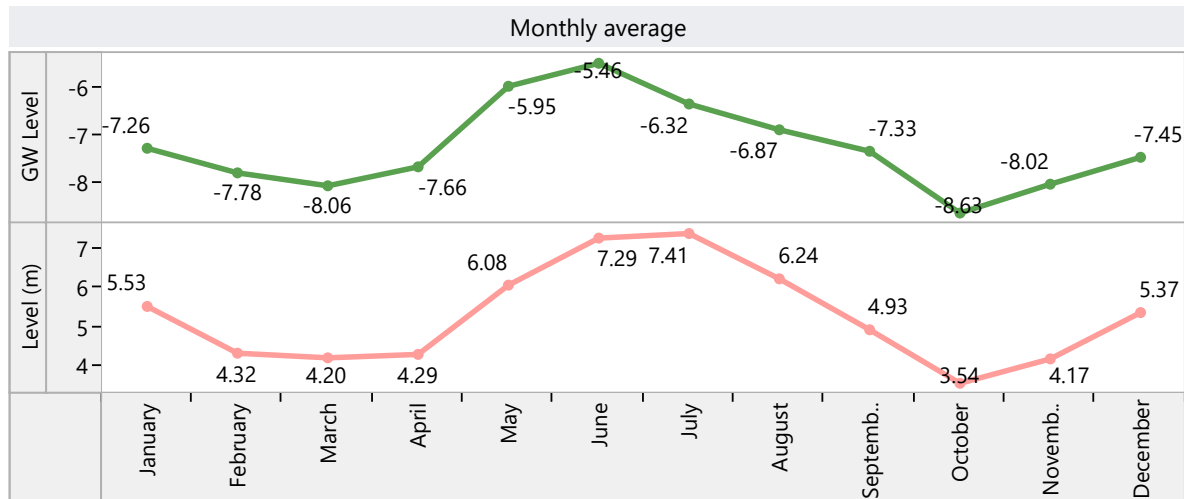
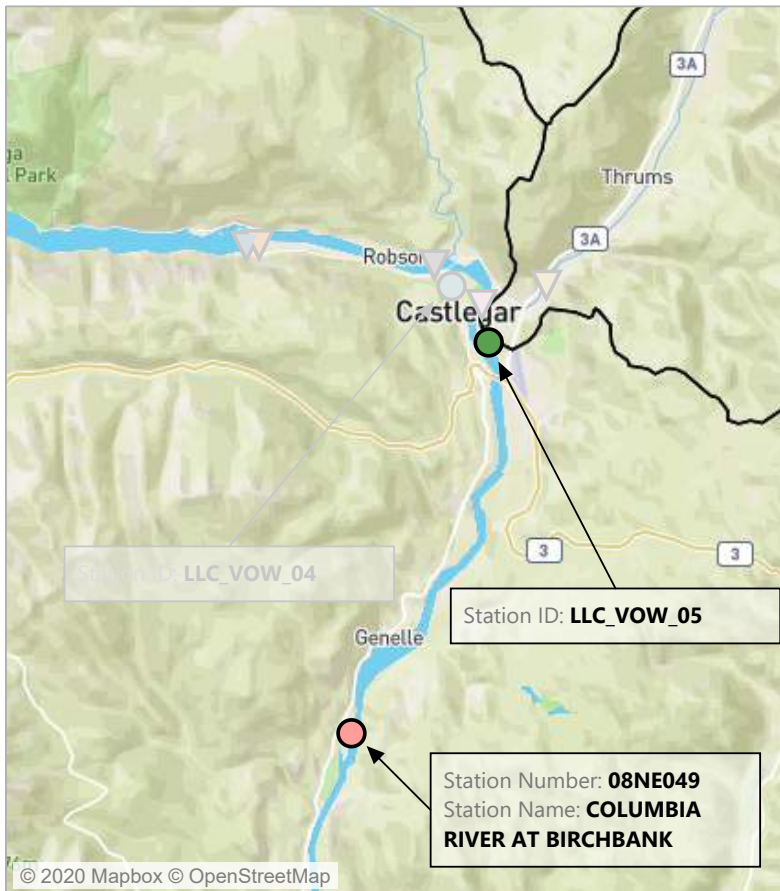

Water Level Yearly Comparison LLC_VOW_05

Station ID
LLC_VOW_05

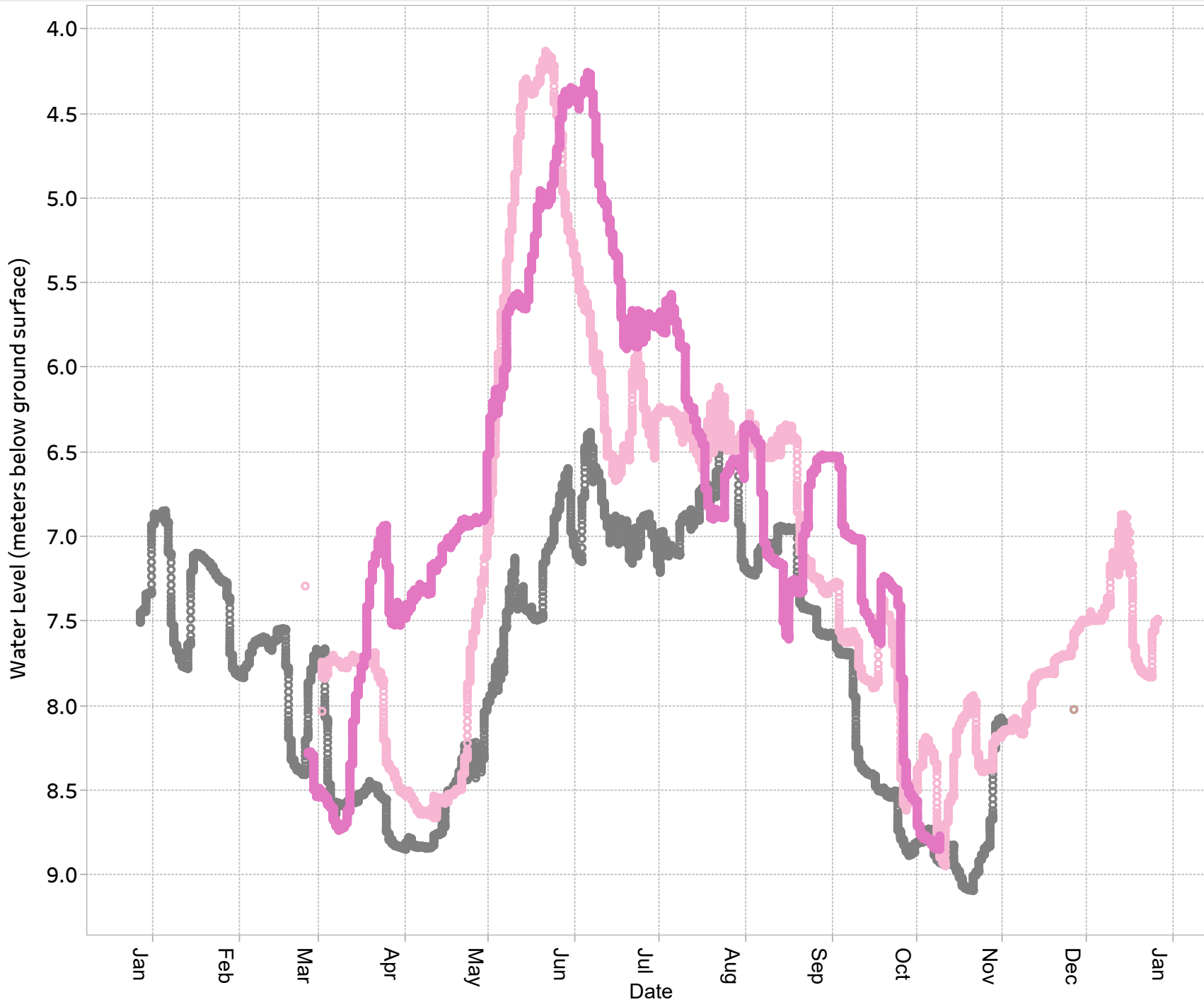

Graphs produced by:



Monitoring Locations: VOW_06 - Aq'am, North side of St. Mary River



Legend

Living Lakes Canada

Volunteer Observation Well (VOW)

- Active

Provincially Mapped Aquifers

- ▭ Bedrock Aquifer
- ▭ Sand & Gravel Aquifer

Wells registered in GWELLS

- Well Decommissioned
- Well assigned to a Mapped Aquifer
- Well not assigned to a Mapped Aquifer

Environmental Monitoring System

Groundwater Sampling

- Spring or Hot Spring
- Well
- Monitoring Well
- Contaminated Site
- Observation Well

Climate Station

- ◆ Environment and Climate Change Canada

Data Sources

- BC Data Catalogue (Groundwater Aquifers, Jun 4 2019; GWELLS, May 9 2019; Environmental Monitoring System, May 29 2019; BC Geographical Names, Dec 13 2019)
- Pacific Climate Impacts Consortium (BC Station Data, Nov 29 2019)
- Google Satellite

Coordinate Reference System: WGS 84 / UTM Zone 11N (EPSG: 32611)

Well Station ID: LLC_VOW_06

Location Description: ʔaᑭam Community, North side of St. Mary's River.

Reason for monitoring: Aquifer 538 identified as priority for monitoring in 2009 PGOWN Review and suggested by FLNRORD.

Well Information

Well Tag Number:	None	Well ID # from owner:	n/a
Well Plate ID:	20279		
Well Stick up (m):	0.305	EMS #	n/a
Well Depth (m):	10.7	Latitude:	49.613703
Well Casing:	6" Steel	Longitude:	-115.7046
		Source of Location	Handheld GPS
Top of Screen (mbgs):	No screen.	Coordinates:	
Bottom of Screen (mbgs):	No screen.		
Confining Layers:	None. Lithology indicates all sand and gravel.		
Initial Well Use/Reason for well construction:	Well drilled by ʔaᑭam for groundwater studies.		

Monitoring Information

Monitoring Status: Active
Monitoring Interval: 2017-02-28 to 2017-05-14- 5 minutes; 2018-08-21 to current- hourly

Length of Monitoring Record: 2017-02-28 to Current

Data available on BC Real-time Water Data Website?

No

Water Level Sensor: HOBO U20-001-04 (Range - 4m)/ replaced with HOBO MX2001-01 (Range -9 m) on 2018-08-21

Data Logger Type: HOBO U20 replaced with HOBO MX2001 on 2018-08-21

Barometric Pressure Sensor: HOBO U20-001-04 replaced with HOBO MX2001 on 2018-08-21 (both installed in airspace in well).

Water Level Sensor Depth (mbgs): 10.9

Comments: Large gap in data associated with water level sensor cable rusting and awaiting new data logger. New water level sensor has plastic casing. Water level fell below the water level sensor on Nov 27-28 2019, which may have been associated with pumping of nearby wells.

Nearest climate station with a complete record

Climate Network Name: Environment Canada (Canadian Daily Climate Data)

Climate Station Location/Name: Cranbrook A

Climate Station Number: 50818

Aquifer Information

Aquifer #:	538
Aquifer Material:	Sand and gravel
Aquifer Area (km²):	11
Aquifer Confinement:	Mostly unconfined
Description¹:	Predominantly unconfined fluvial or glaciofluvial sand and gravel Aquifers found along major rivers of higher stream order with the potential to be hydraulically influenced by the river (subtype = 1a).
Likelihood of hydraulic connection¹:	Likely (based on broad regional assessment)
Hydraulic Connection Assessment by LLC²:	The aquifer is likely hydraulically connected to both the Kootenay and St. Mary Rivers
Rational for Hydraulic Connection Assessment by LLC³:	The southern and eastern boundaries follow Kootenay and St. Mary Rivers. The northern and western boundaries roughly follow the edge of the fluvial valley. Aquifer materials consist of fluvial sand and gravel. General flow direction is likely towards the Kootenay River to the east and south towards St. Mary River. Shallow aquifer, depth varies between 2.4 m - 11.6 m. Recharge is through surface and groundwater. Water table is high as seen in the seasonal fluctuation of regional kettle lakes. The shallow water table appears to be in direct contact with both rivers.

Foot Notes

¹From Provincial aquifer factsheets available at <https://apps.nrs.gov.bc.ca/gwells/aquifers>

²Assessed by Living Lakes Canada. See methods in report.

³Rational for hydraulic connectivity assessment by Living Lakes Canada.



GW SOLUTIONS
ASSESSMENT & PROTECTION OF GROUNDWATER



WELL ID:
LLC_VOW_06

EASTING: 593578
NORTHING: 5496488
DATE COMMENCED: 27 March, 2008
DATE COMPLETED: 28 March, 2008

LOCATION: Columbia Basin
CONTRACTOR:
STICK UP (m): 0.30

WELL ID PLATE No.: 20279
BC WELL TAG No.:
DRILL RIG: Air Rotary
DRILLER: Tim Hoechsmann
LOGGED BY: Driller

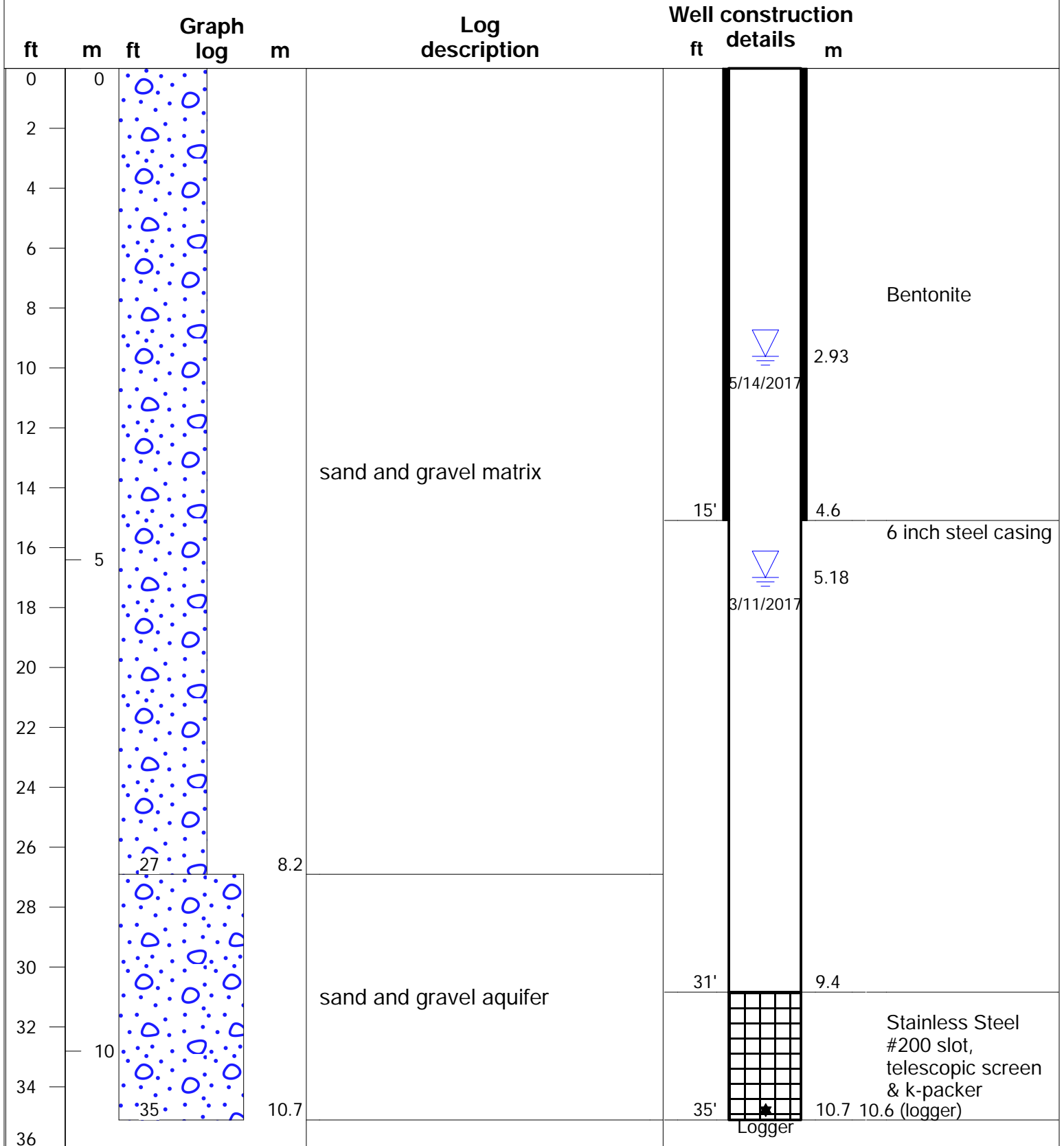

Water Level & Water Temperature Station ID: LLC_VOW_06

Station ID
LLC_VOW_06

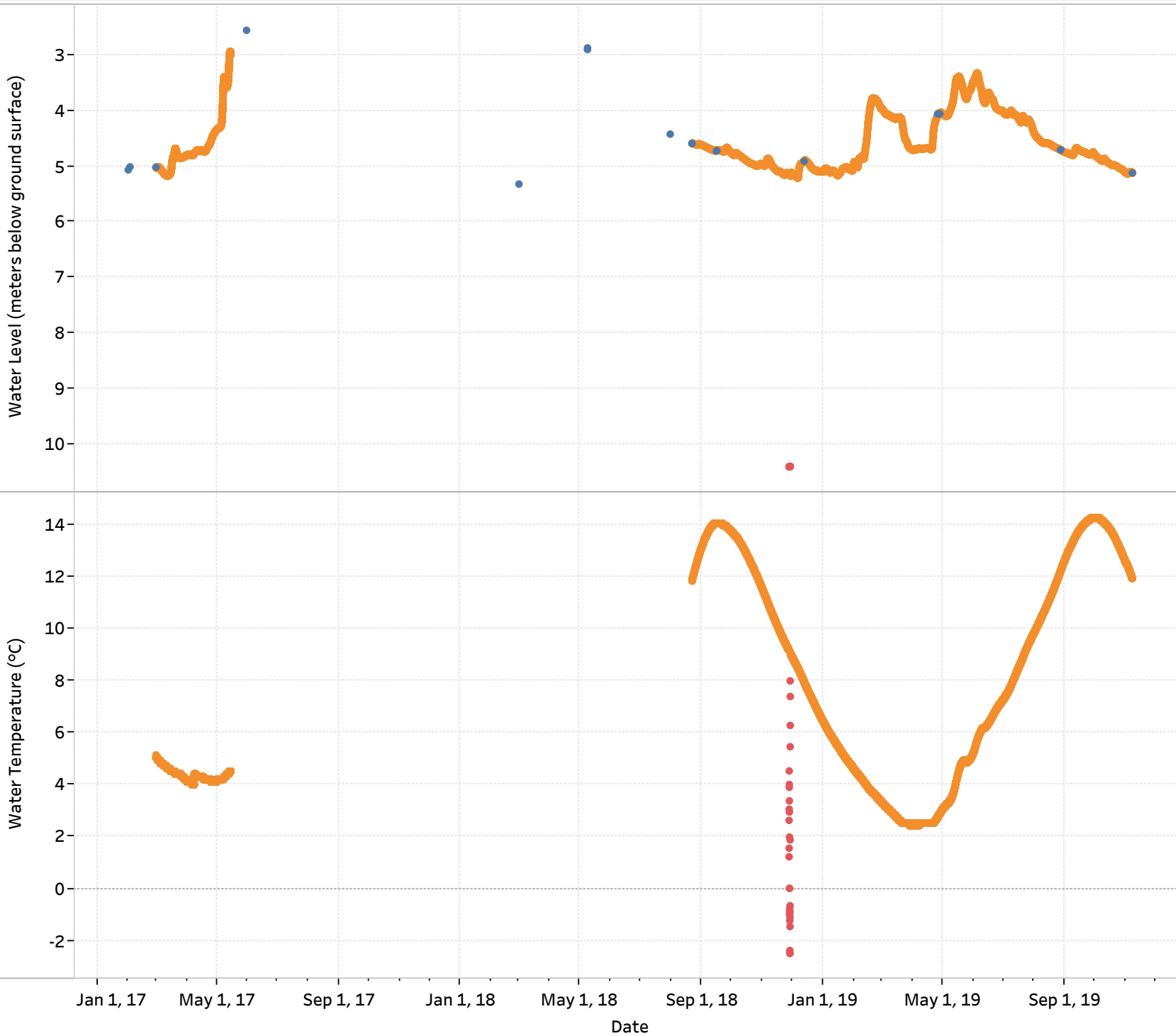

Measurement Type
Logger dewatered
Manual data
Logger data

Well depth (mbgs)

10.7

Depth of Water Level Sensor (mbgs)

10.9 mbgs



Graphs produced by:

C Waters Consulting



GW SOLUTIONS
ASSESSMENT & PROTECTION OF GROUNDWATER

Water Level & Daily Total Precipitation

Station ID: LLC_VOW_06

Station ID Groundwater
 LLC_VOW_06

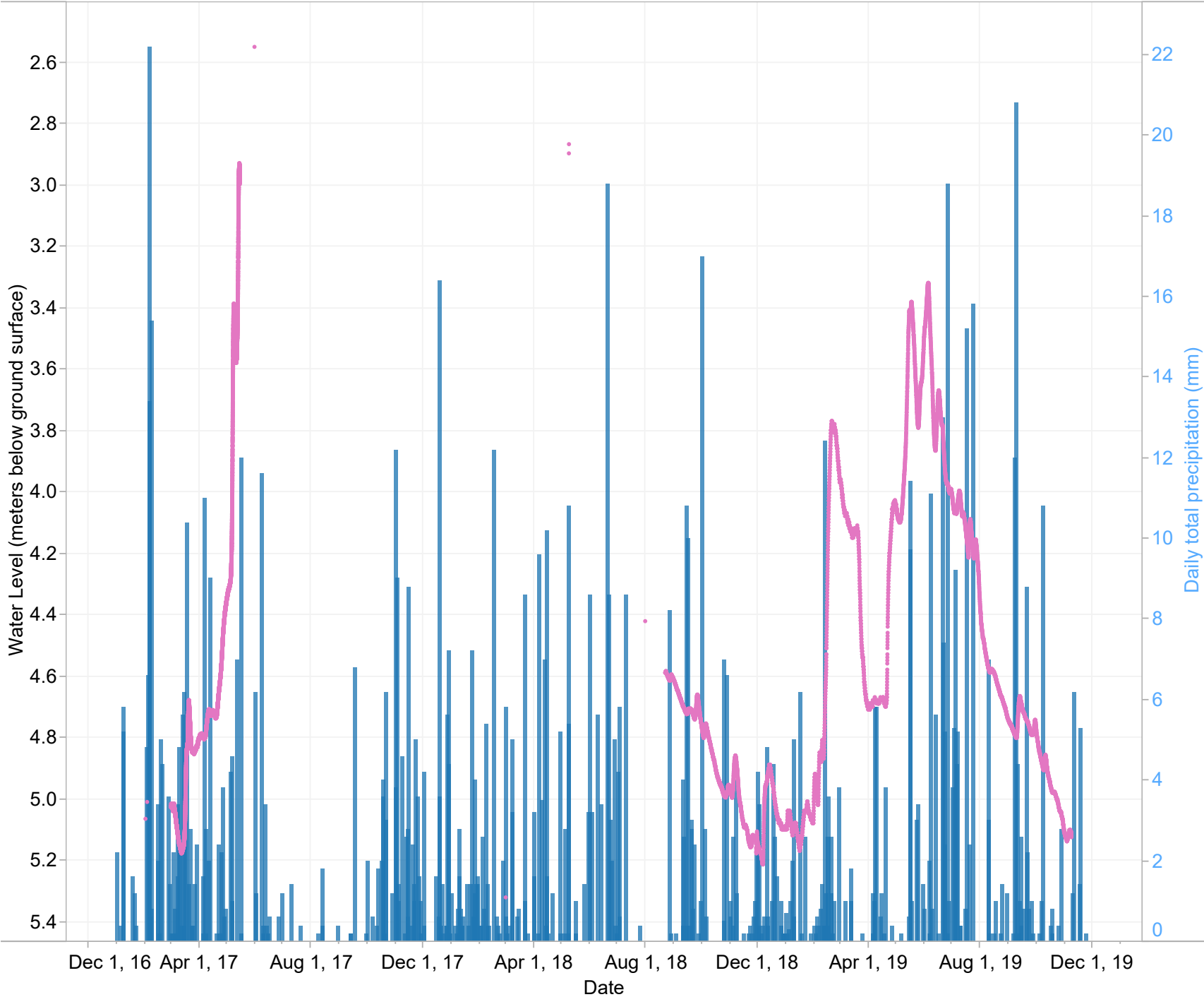

Station ID Legend

- 50818
- LLC_VOW_06

Precipitation	50818	CRANBROOK A
Groundwater	LLC_VOW_06	?aqam Community, North side of St.Mary's River.



Graphs produced by:

C Waters Consulting



GW SOLUTIONS
ASSESSMENT & PROTECTION OF GROUNDWATER

Water Level & Cumulative Precipitation Departure from Average (CPD)

Station ID: LLC_VOW_06

Station ID Groundwater
LLC_VOW_06

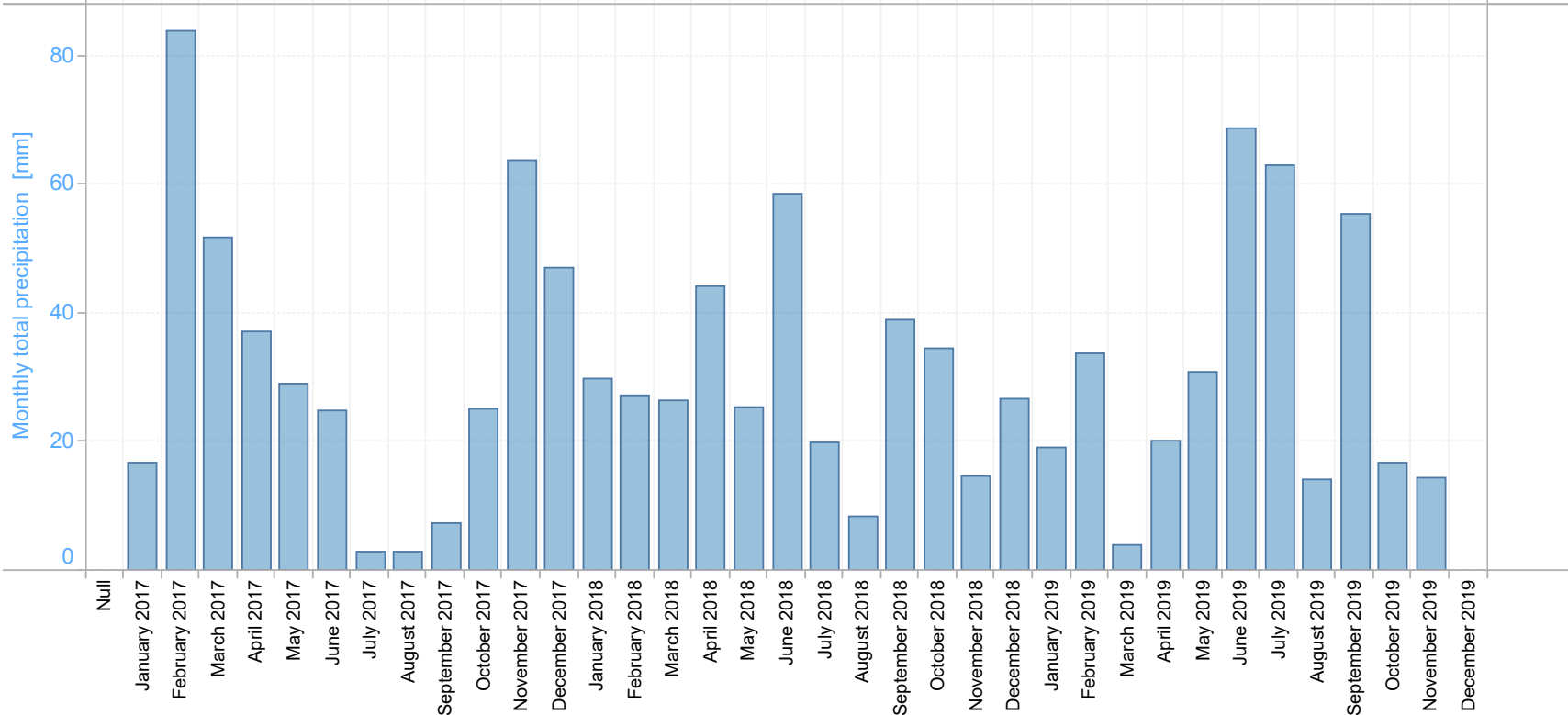
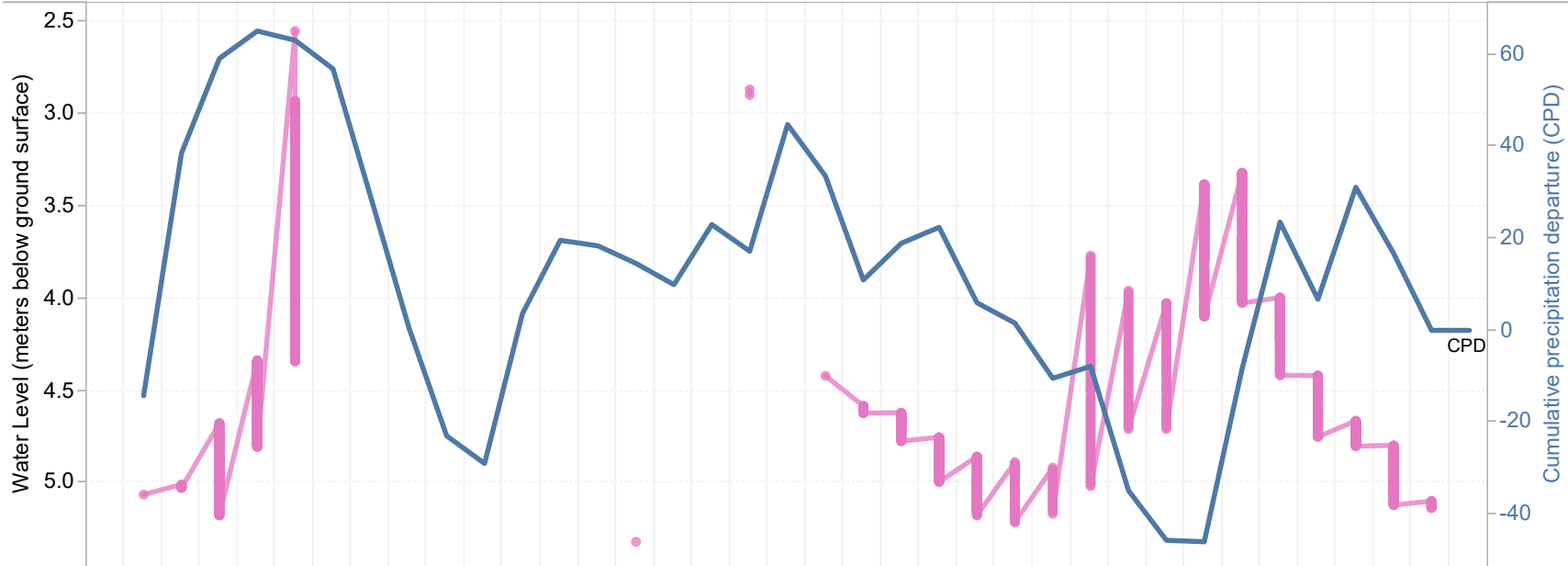

Graphs produced by:

C Waters Consulting



Historical daily flow data for KOOTENAY RIVER AT FORT STEELE & LLC_VOW_06 (All)

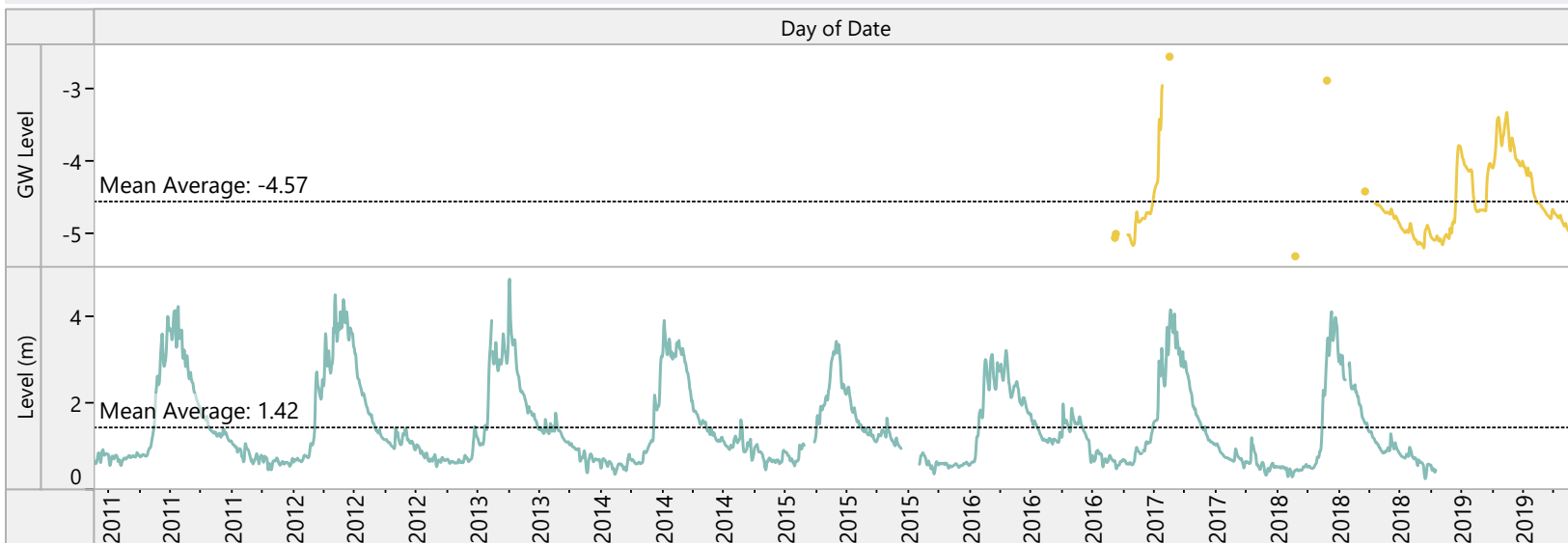

Parameter
Multiple values

Station Status
● ACTIVE
▼ DISCONTINUED

Station ID
08NG065
LLC_VOW_06

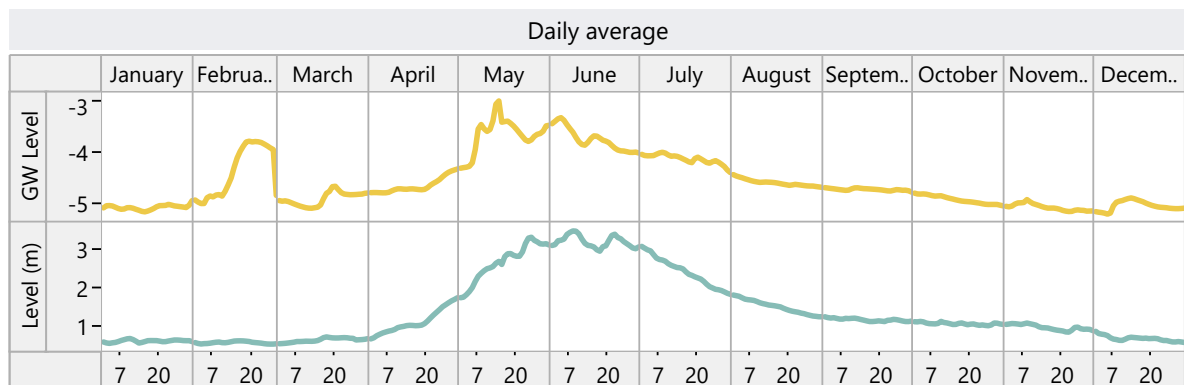
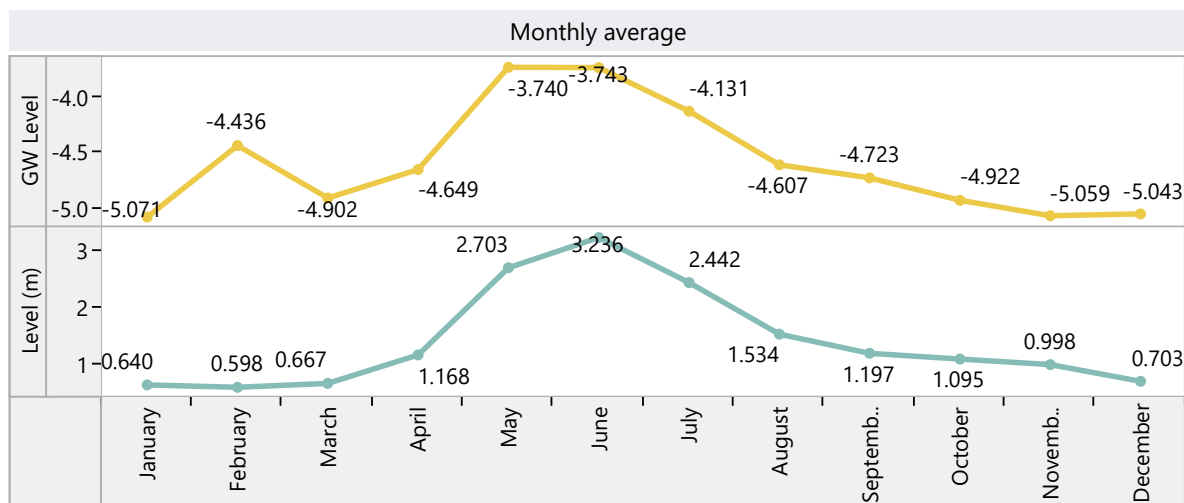
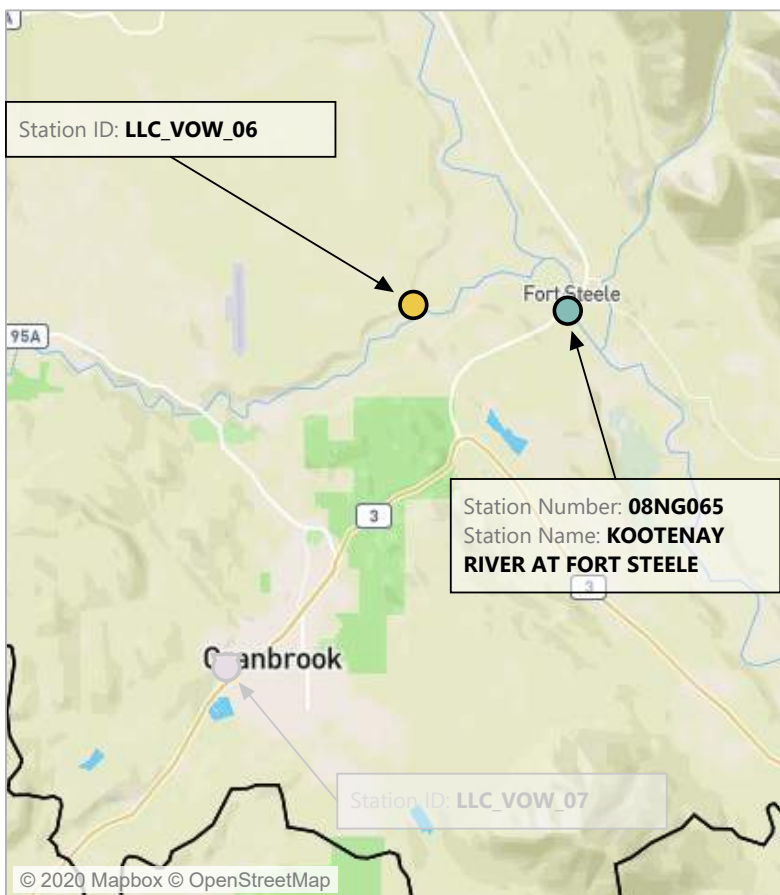

Water Level Yearly Comparison LLC_VOW_06

Station ID
LLC_VOW_06

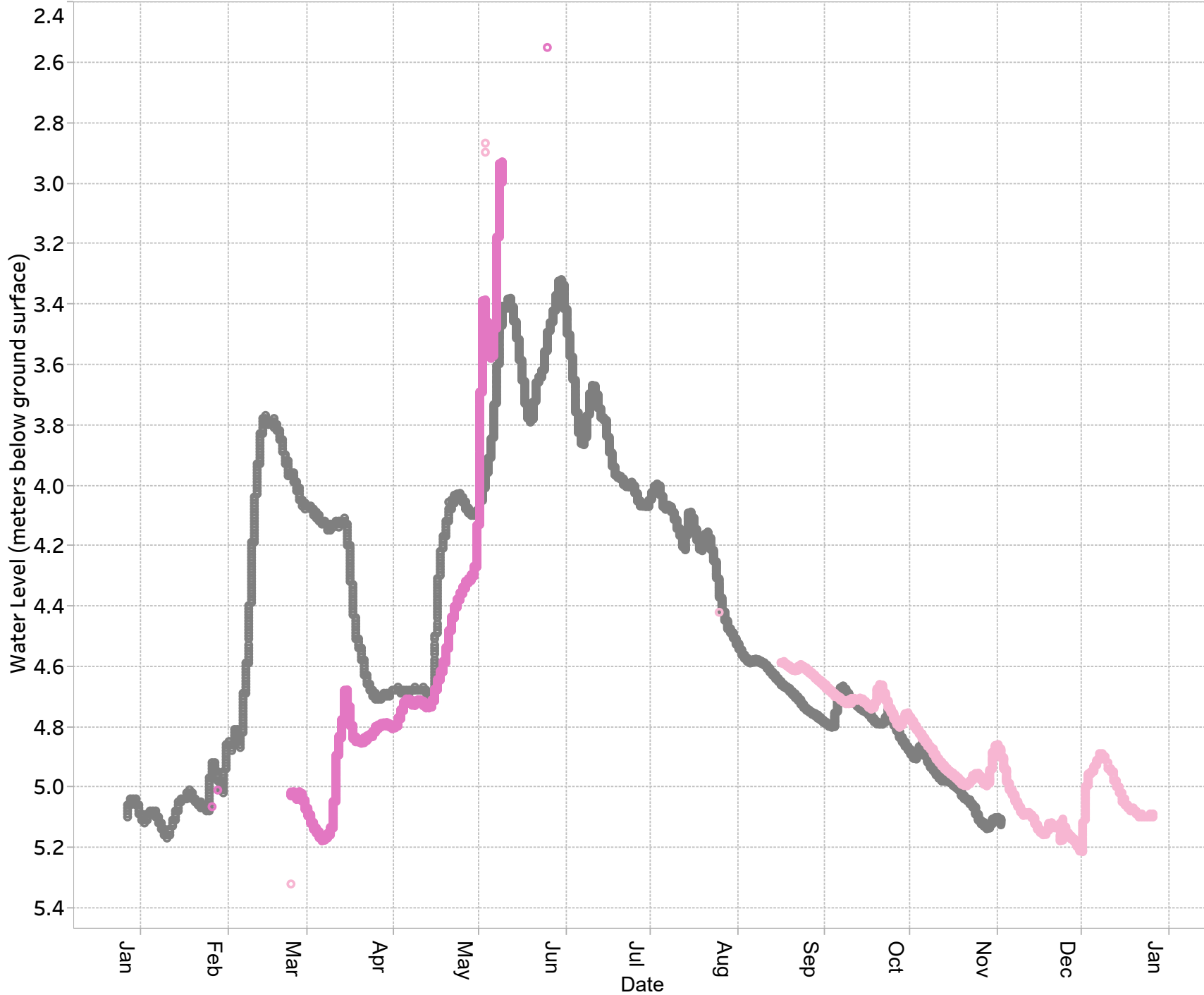

Graphs produced by:

C Waters
Consulting



Monitoring Locations: VOW_07 & VOW_08 - Cranbrook, Laurier Street West.

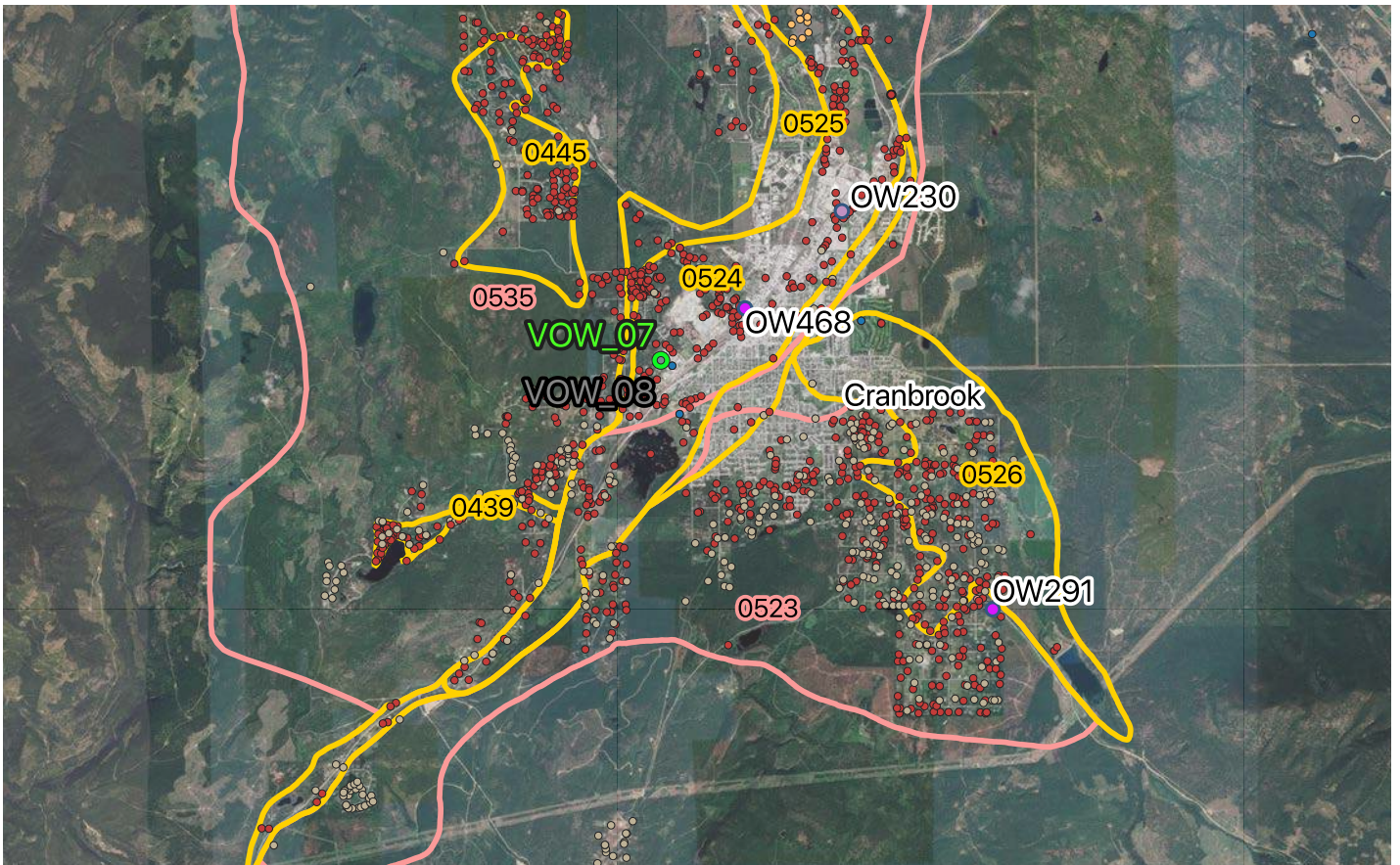

Legend

Living Lakes Canada

Volunteer Observation Well (VOW)

- Active
- Inactive

Provincial Groundwater Observation Well (OW)

- Active
- Inactive

Provincially Mapped Aquifers

- Bedrock Aquifer
- Sand & Gravel Aquifer

Wells registered in GWELLS

- Well Decommissioned
- Well assigned to a Mapped Aquifer
- Well not assigned to a Mapped Aquifer

Environmental Monitoring System Groundwater Sampling

- Spring or Hot Spring
- Well
- Monitoring Well
- Contaminated Site
- Observation Well



0 1 2 km



Data Sources

- BC Data Catalogue (Groundwater Aquifers, Jun 4 2019; GWELLS, May 9 2019; Environmental Monitoring System, May 29 2019; BC Geographical Names, Dec 13 2019)
- Pacific Climate Impacts Consortium (BC Station Data, Nov 29 2019)
- Google Satellite

Coordinate Reference System: WGS 84 / UTM Zone 11N (EPSG: 32611)

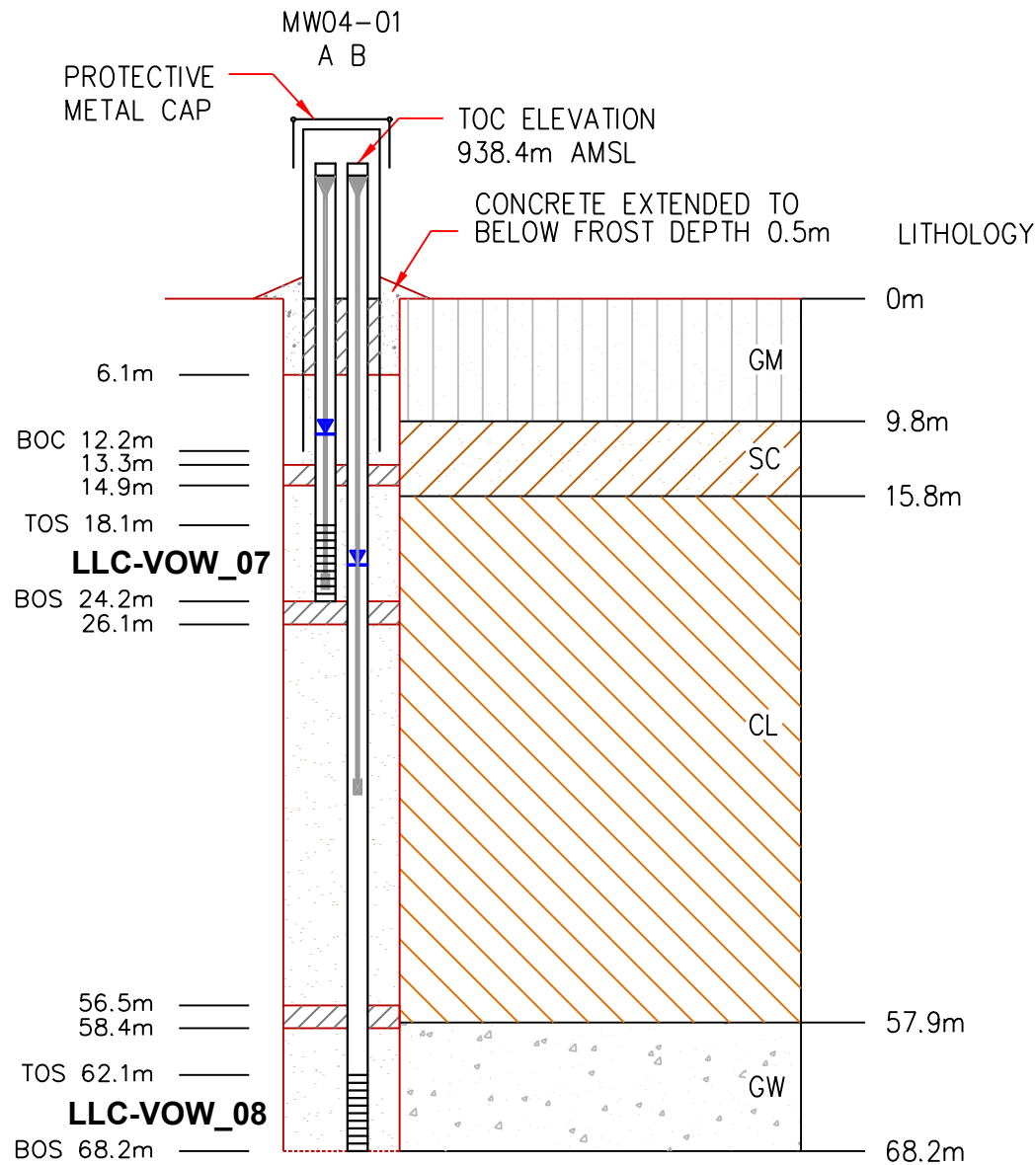

MW04-01			
WELL	DEPTH	STATIC WATER LEVEL	TRANSDUCER DEPTH
A	24.2m	10.85m	22m
B	68.2m	21.28m	45m

N.B. - EACH MONITORING WELL COMPLETED
HERON DIPPER MODULE TRANSDUCER/
DATA LOGGER

LEGEND

- TOC top of casing
- TOS top of screen
- BOS bottom of screen
- sand layers
- bentonite layers

STRATIGRAPHY LEGEND

- GM silty gravels, gravel-sand-silty mixtures
- SC clayey sands, sand-clay mixtures
- CL inorganic clays of low to medium plasticity, gravelly clays, sandy clays, silty clays, lean clays
- GW well-graded gravels, gravel-sand mixtures, little or no fines



KALA GROUNDWATER CONSULTING LTD.
VERNON KAMLOOPS

1314 MCGILL ROAD
TEL. (250) 372-9194

KAMLOOPS, BC, V2C 6N6
FAX (250) 372-9398

Notes: This diagram is for conceptual purposes only,
locations and configurations are approximate only.

Date: Jan. 2004 Drawn By: KML Approved By:

Scale: As Shown Ref: 03535 File Ref: 03535Fig3.dwg

Client: Corporation of the City of Cranbrook

Project Description: Monitoring Well Installation
Cranbrook, B.C.

Diagram: Monitoring Well Completion Diagram

Fig: 3

Lithology for LLC-VOW_07 and LLC-VOW_08

Table 1 - Drilling Stratigraphy – Cranbrook MW04-01	
Depth (m)	Formation Description
0-6.1	Silty sand and gravel, isolated cobbles, hard, moist.
6.1 – 9.8	Silty sand and gravel, isolated cobbles, isolated boulders, hard, dry.
9.8 – 15.8	Sandy clay and gravel, moist.
15.8 – 18.3	Clay, some sand, saturated. W.B.
18.3 – 24.4	Clay, some sand, some gravel, isolated cobbles, compact, wet. W.B.
24.4 – 35.1	Clay, trace sand, very trace gravel, compact, damp.
35.1 – 38.1	Clay, some gravel, trace sand, compact, moist.
38.1 – 50.3	Clay, compact, saturated. W.B.
50.3 – 57.9	Clay, saturated, big boulder.
57.9 – 67.1	Gravel, some sand, saturated. W.B.

Well Station ID: LLC_VOW_07

Location Description: Cranbrook, Laurier St. W.

Reason for monitoring: Aquifer 524 identified as priority for monitoring in 2009 PGOWN Review and suggested by FLNRORD.

Well Information

Well Tag Number:	None	Well ID # from owner:	MW04-01 A
Well Plate ID:	None		
Well Stick up (m):	1.52	EMS #	n/a
Well Depth (m):	24.2	Latitude:	49.508275
Well Casing:	Nested well in steel casing; Steel casing to 12.2 mbgs	Longitude:	-115.7885
Top of Screen (mbgs):	18.1	Source of Location	
Bottom of Screen (mbgs):	24.2	Coordinates:	Handheld GPS
Confining Layers:	Clayey sands/sand clay mixture (9.8 - 15.8 mbgs)		
Initial Well Use/Reason for well construction:	Well drilled by Kala Geosciences for groundwater studies.		

Monitoring Information

Monitoring Status: Active

Monitoring Interval: 2008-07-24 to 2017-05-24 -2 hours; 2020-02-14- Current- Hourly

Length of Monitoring Record: 2008-07-24 to 2017-05-24; 2020-02-14-Current

Data available on BC Real-time Water Data Website? Yes

Water Level Sensor: Heron Dipper Module- 2008-07-24 to 2017-05-24; HOBO MX-2001-01 (range 9 m) - 2020-0214- Current

Data Logger Type: Heron Dipper Module w/various sensors -2008-07-24 to 2017-05-24 - HOBO MX 2001 2020-02-14 to Current

Barometric Pressure Sensor: HOBO MX2001-2020-02-14 -Current

Water Level Sensor Depth (mbgs): 22

Comments: Differences in water temperatures among different monitoring intervals may be associated with different sensors (with different accuracies) and with sensors being installed at different depths.

Nearest climate station with a complete record

Climate Network Name: Environment Canada (Canadian Daily Climate Data)

Climate Station Location/Name: Cranbrook A

Climate Station Number: 50818

Aquifer Information

Aquifer #:	524
Aquifer Material:	Sand and gravel
Aquifer Area (km²):	21.8
Aquifer Confinement:	Unconfined; part of this shallow aquifer is overlain by low permeable materials
Description¹:	Unconfined glaciofluvial outwash or ice contact sand and gravel aquifers, generally formed near or at the end of the last period of glaciation. (subtype = 2a) (Note- information from detailed Aquifer Mapping Report; aquifer factsheet states this aquifer is 4b and confined which does not match Aquifer Mapping Report)
Likelihood of hydraulic connection¹:	Not likely (based on broad regional assessment)
Hydraulic Connection Assessment by LLC²:	May be hydraulically connected to nearby tributary streams.
Rational for Hydraulic Connection Assessment by LLC³:	Flow direction has not been determined. Recharge is through influent tributary streams, which is likely because of the proximity of the unconfined aquifer to the surface.

Foot Notes

¹From Provincial aquifer factsheets available at <https://apps.nrs.gov.bc.ca/gwells/aquifers>

²Assessed by Living Lakes Canada. See methods in report.

³Rational for hydraulic connectivity assessment by Living Lakes Canada.

Water Level & Water Temperature Station ID: LLC_VOW_07

Station ID
LLC_VOW_07

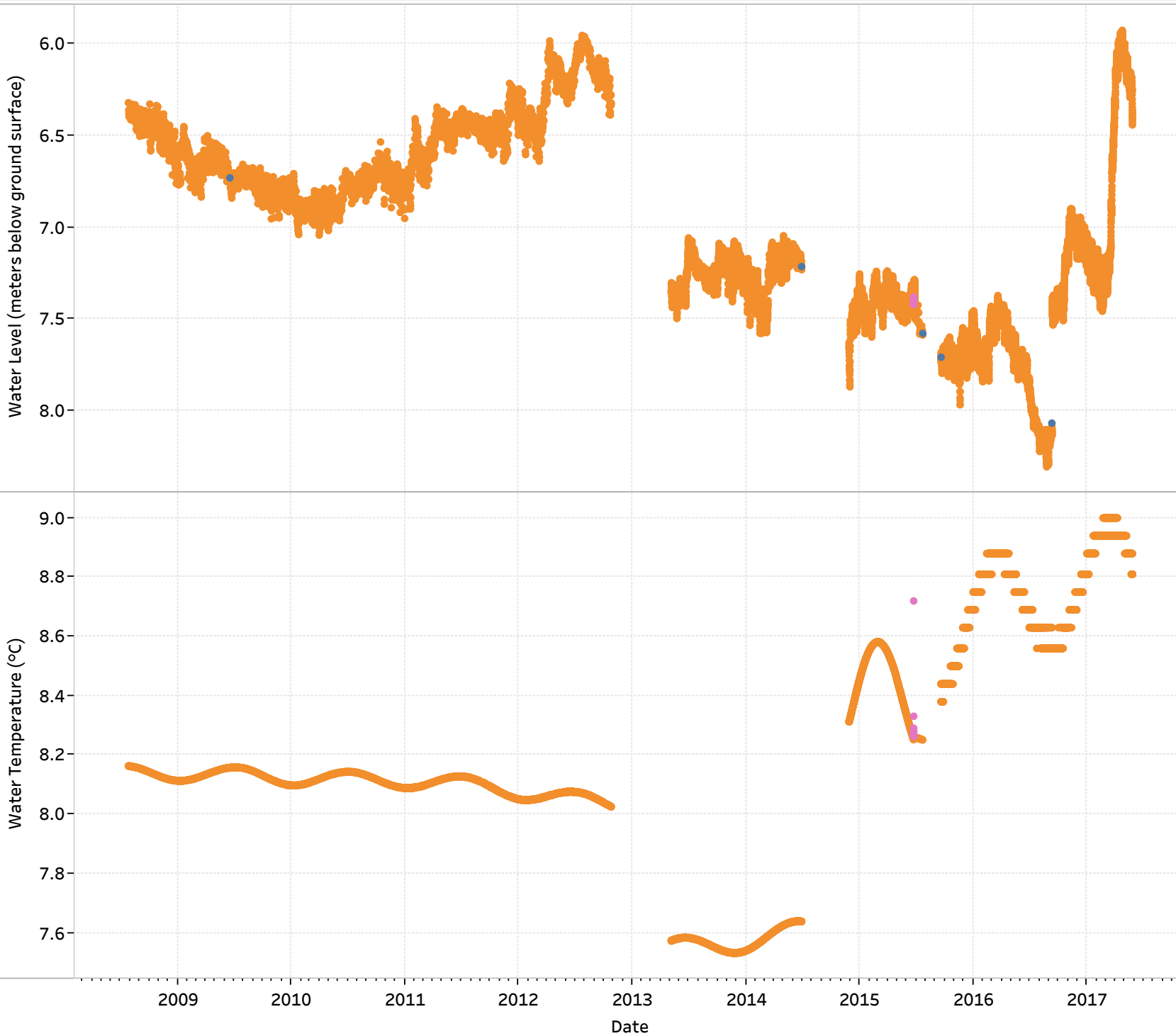

Measurement Type

- Outlier
- Manual data
- Logger data

Well depth (mbgs)

24.2

Depth of Water Level
Sensor (mbgs)

22 mbgs



Graphs produced by:

**C Waters
Consulting**



GW SOLUTIONS
ASSESSMENT & PROTECTION OF GROUNDWATER

Water Level & Daily Total Precipitation

Station ID: LLC_VOW_07

Station ID Groundwater
LLC_VOW_07

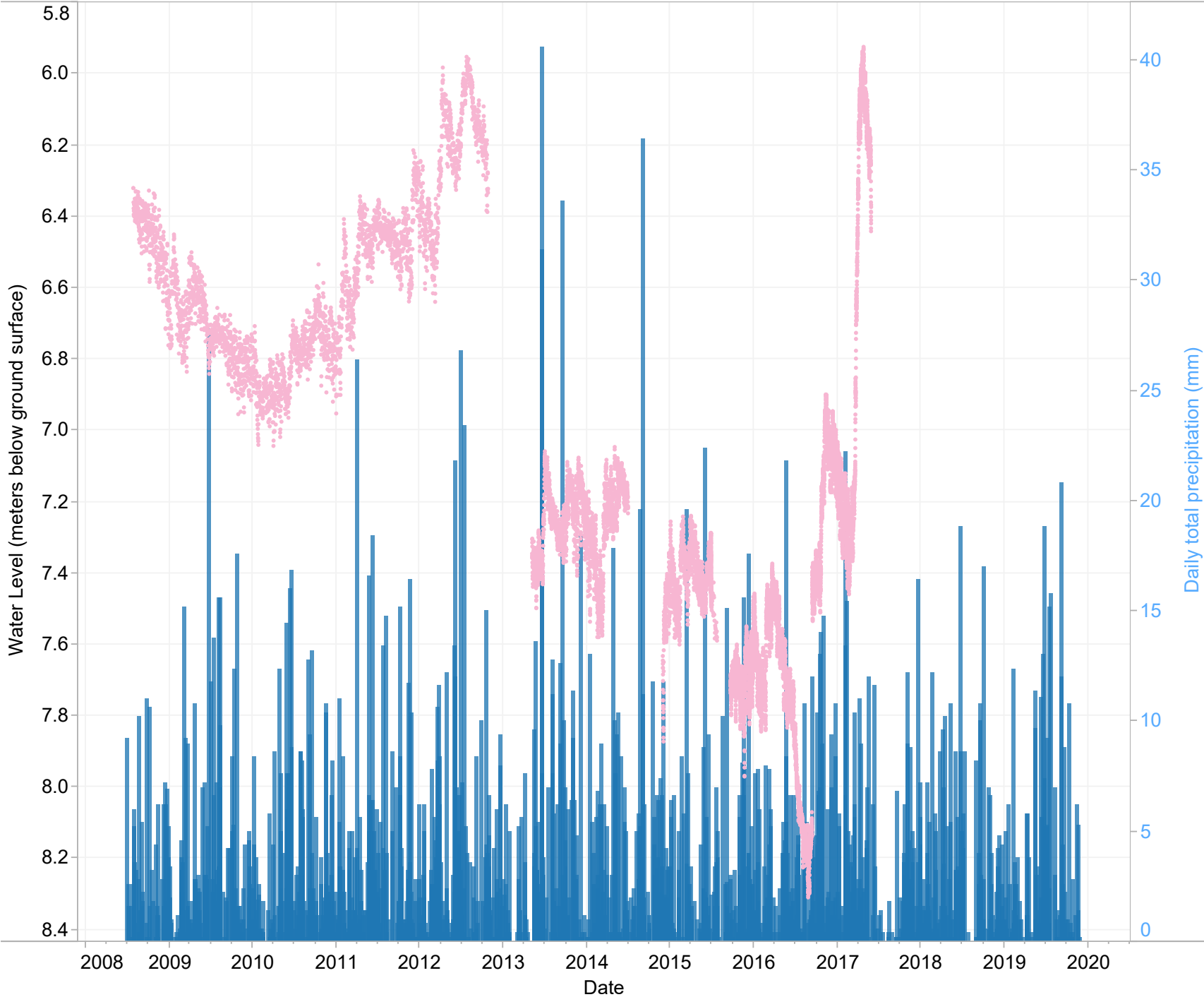

Station ID Legend

- 50818
- LLC_VOW_07

Precipitation	50818	▲ CRANBROOK
Groundwater	LLC_VOW_07	▲ Cranbrook, Laurier St. W.



Graphs produced by:

C Waters Consulting



GW SOLUTIONS
ASSESSMENT & PROTECTION OF GROUNDWATER

Water Level & Cumulative Precipitation Departure from Average (CPD)

Station ID: LLC_VOW_07

Station ID Groundwater
LLC_VOW_07

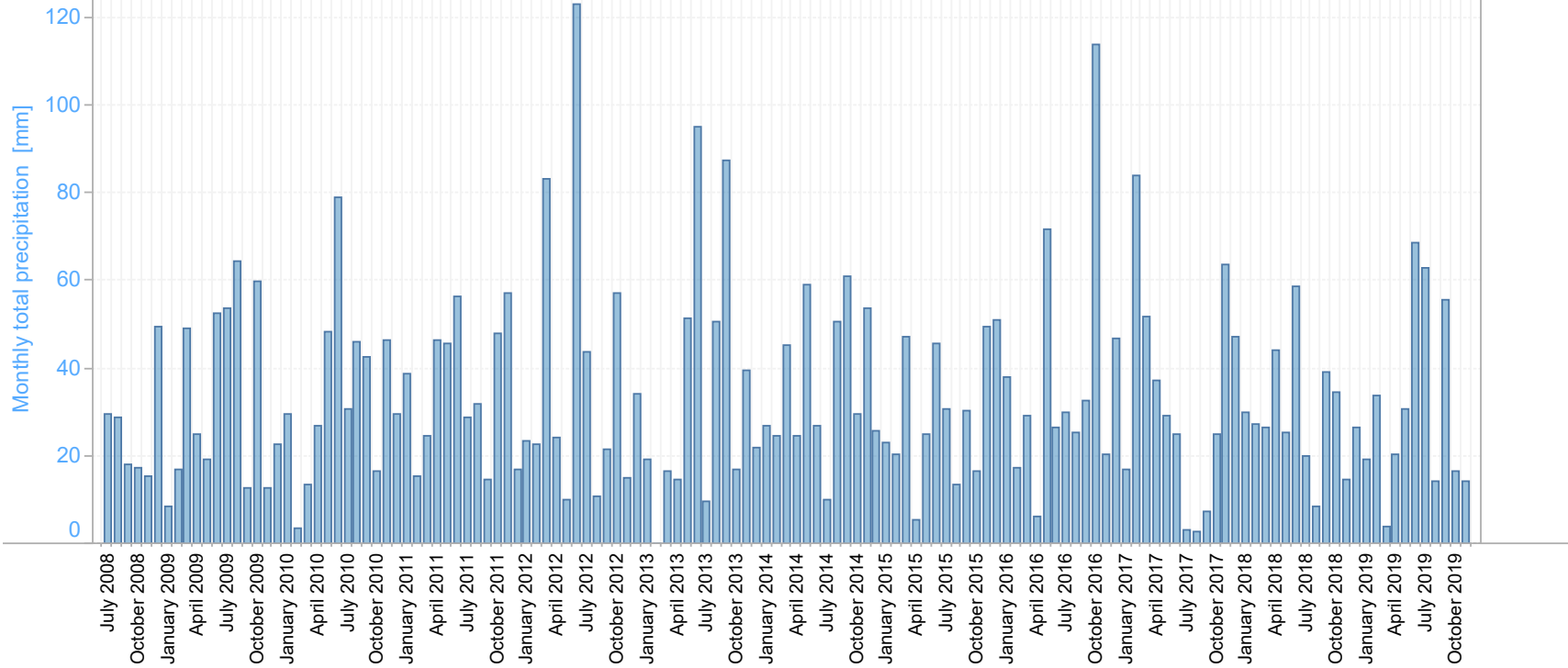
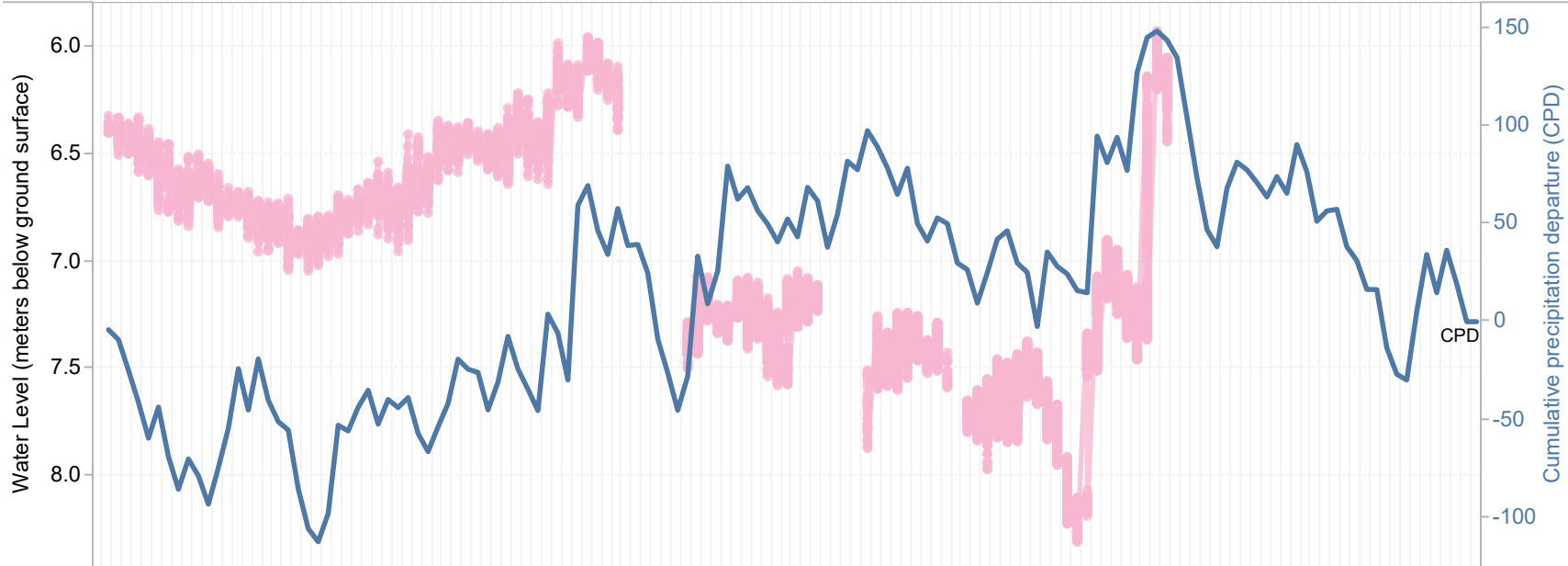

Graphs produced by:

C Waters
Consulting



GW SOLUTIONS
ASSESSMENT & PROTECTION OF GROUNDWATER

Historical daily flow data for KOOTENAY RIVER AT FORT STEELE & LLC_VOW_07 (All)

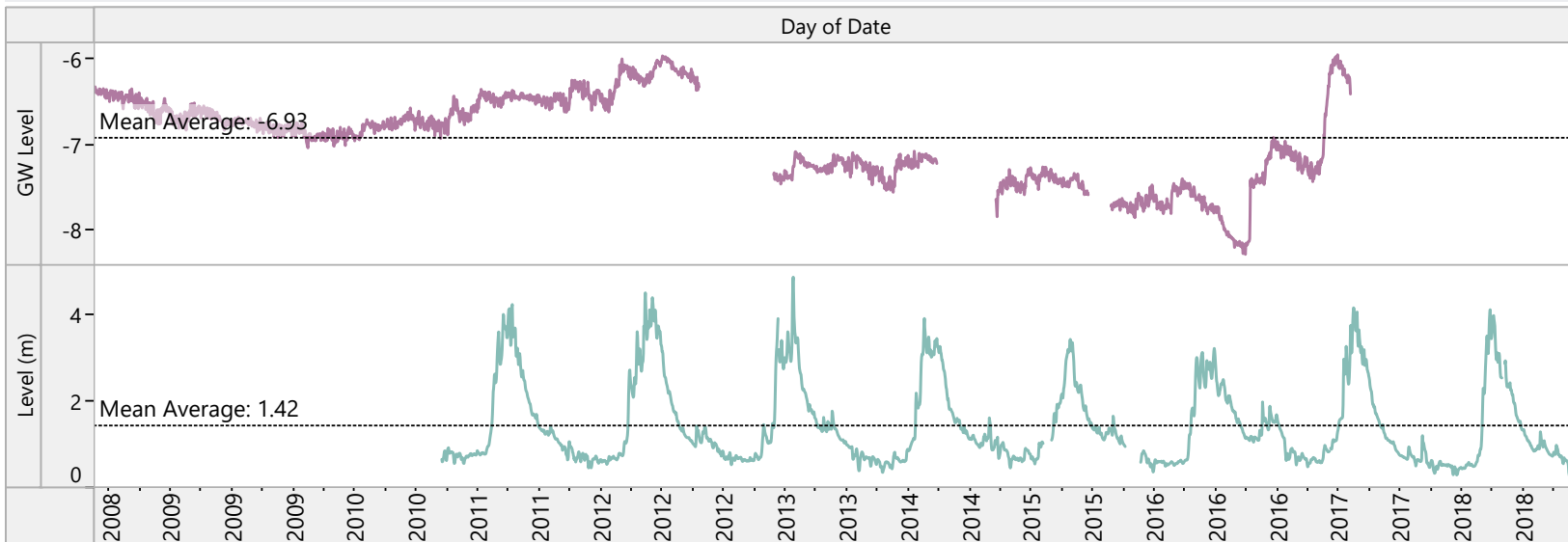

Parameter
Multiple values

Station Status
● ACTIVE
▼ DISCONTINUED

Station ID
08NG065
LLC_VOW_07

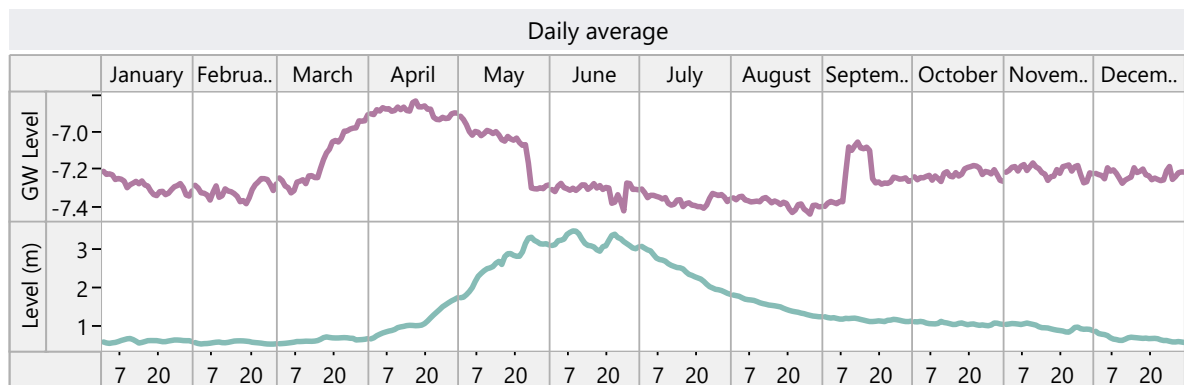
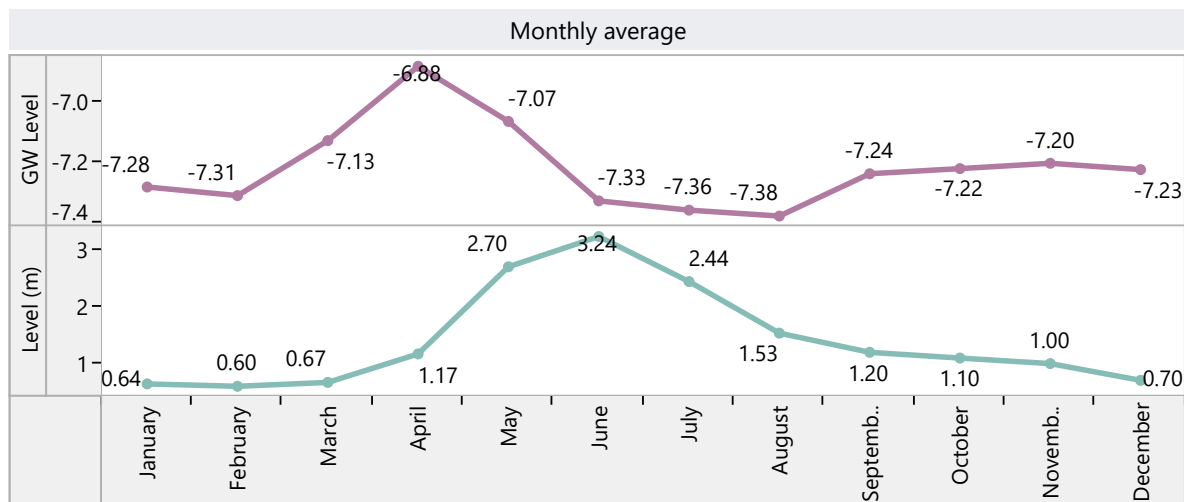
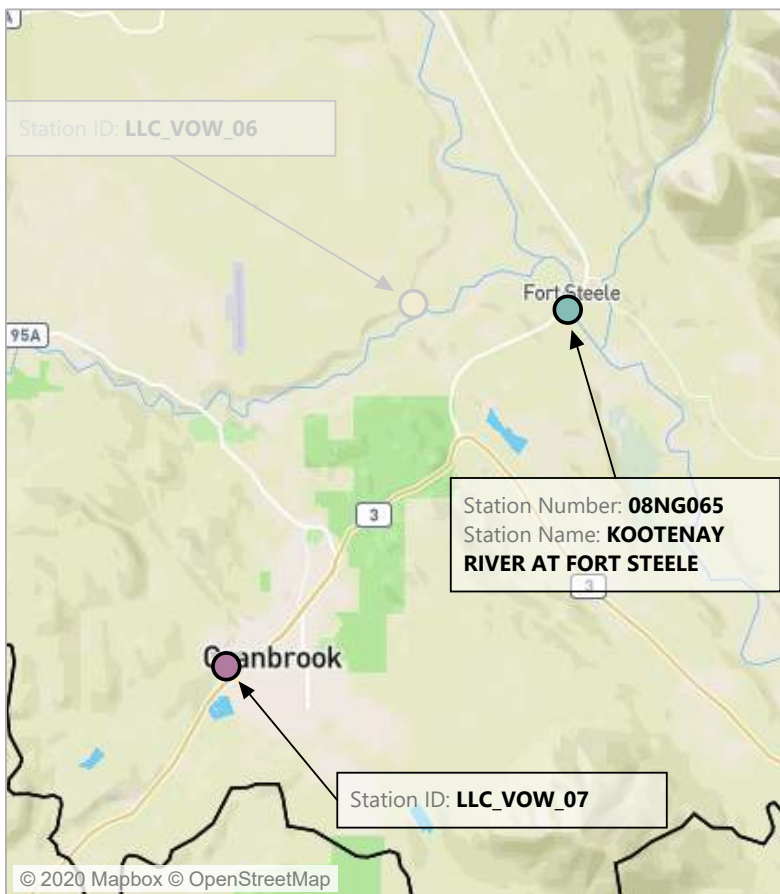

Water Level Yearly Comparison LLC_VOW_07

Station ID
LLC_VOW_07

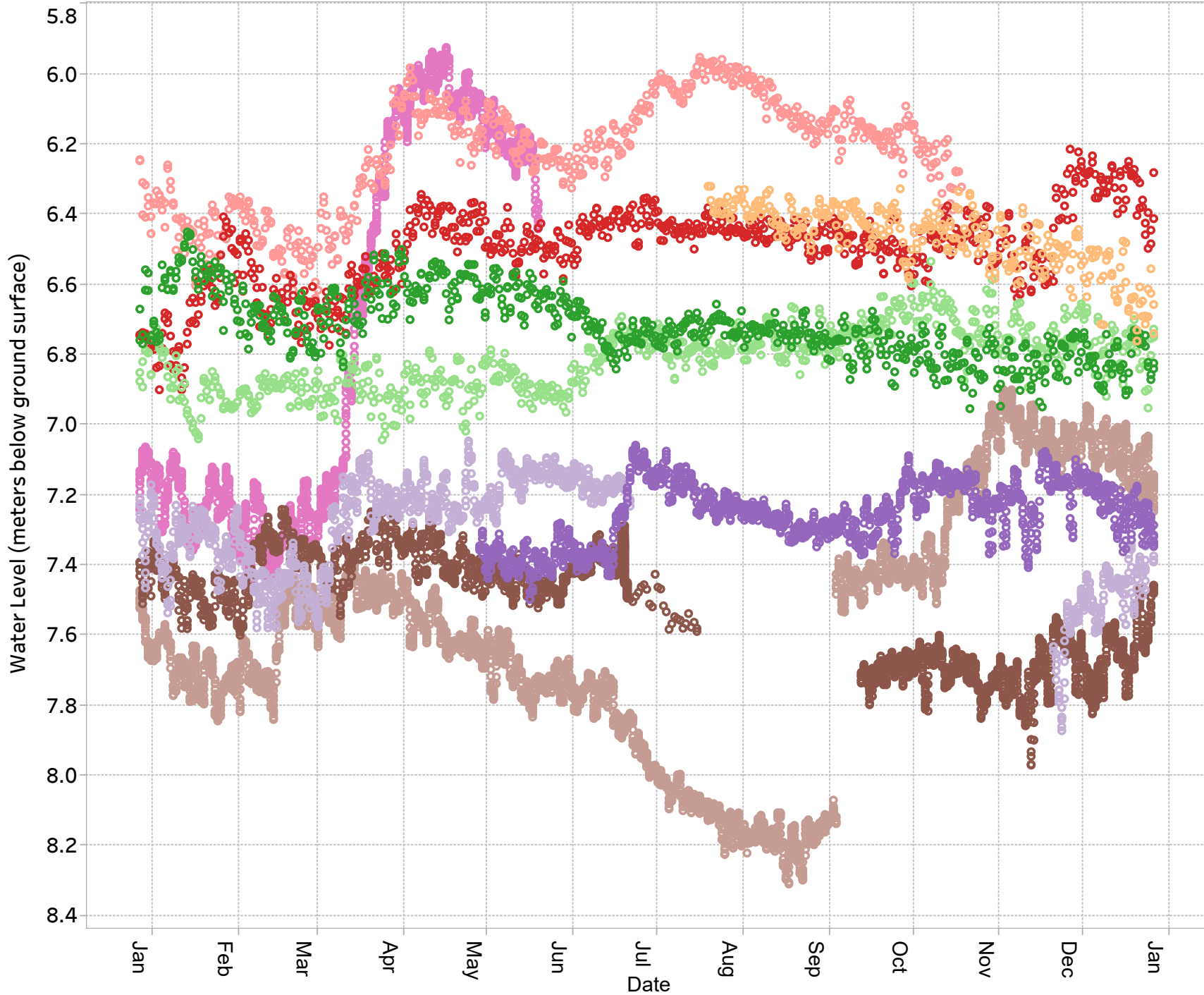

- YEAR**
- 2008
 - 2009
 - 2010
 - 2011
 - 2012
 - 2013
 - 2014
 - 2015
 - 2016
 - 2017



Graphs produced by:

C Waters
Consulting



Well Station ID: LLC_VOW_08

Location Description: Cranbrook, Laurier St. W.
Reason for monitoring: Aquifer 525 identified as priority for monitoring in 2009 PGOWN Review and suggested by FLNRORD.

Well Information

Well Tag Number: None **Well ID # from owner:** MW04-01 B
Well Plate ID: None
Well Stick up (m): 1.52 **EMS #** n/a
Well Depth (m): 68.2 **Latitude:** 49.508281
Well Casing: Nested well in steel casing; Steel casing to 12.2 mbgs **Longitude:** -115.7885
Top of Screen (mbgs): 62.1 **Source of Location**
Bottom of Screen (mbgs): 68.2 **Coordinates:** Handheld GPS
Clayey sands/sand clay mixture (9.8 - 15.8 mbgs); inorganic clays of low to medium plasticity, gravelly clays, sandy clays, silty clays, lean clays (15.8-57.9 mbgs)
Confining Layers:
Initial Well Use/Reason for well construction: Well drilled by Kala Geosciences for groundwater studies.

Monitoring Information

Monitoring Status: Discontinued.
Monitoring Interval: 2 hours
Length of Monitoring Record: 2008-07-24 to 2017-05-24
Data available on BC Real-time Water Data Website? No
Water Level Sensor: Heron Dipper Module
Data Logger Type: Heron Dipper Module
Barometric Pressure Sensor: Heron Dipper Module
Water Level Sensor Depth (mbgs): 45
Comments: Water levels likely influenced by pumping of nearby wells and the nearby quarry. In 2018, the PGOWN established Observation Well #486 in Aquifer 525. Not recommended to keep monitoring.

Nearest climate station with a complete record

Climate Network Name: Environment Canada (Canadian Daily Climate Data)
Climate Station Location/Name: Cranbrook A
Climate Station Number: 50818

Aquifer Information

Aquifer #:	525
Aquifer Material:	Sand and gravel
Aquifer Area (km²):	30
Aquifer Confinement:	Confined
Description¹:	Confined glacio-fluvial sand and gravel aquifers underneath till, in between till layers, or underlying glacio-lacustrine deposits (subtype = 4b).
Likelihood of hydraulic connection¹:	Not likely (based on broad regional assessment)
Hydraulic Connection Assessment by LLC²:	Not hydraulically connected
Rational for Hydraulic Connection Assessment by LLC³:	Deeper than no.524. moderately shallow, 2.7 m -78.6 m. Aquifer flows to the Northeast in a deep bedrock valley to the St. Mary River with a recharge mounding effect in the Hospital Creek area. Other data suggests the aquifer flows south towards Moyie Lake. Recharge is from influent tributary rivers.

Foot Notes

¹From Provincial aquifer factsheets available at <https://apps.nrs.gov.bc.ca/gwells/aquifers>

²Assessed by Living Lakes Canada. See methods in report.

³Rational for hydraulic connectivity assessment by Living Lakes Canada.

Water Level & Water Temperature Station ID: LLC_VOW_08

Station ID
LLC_VOW_08

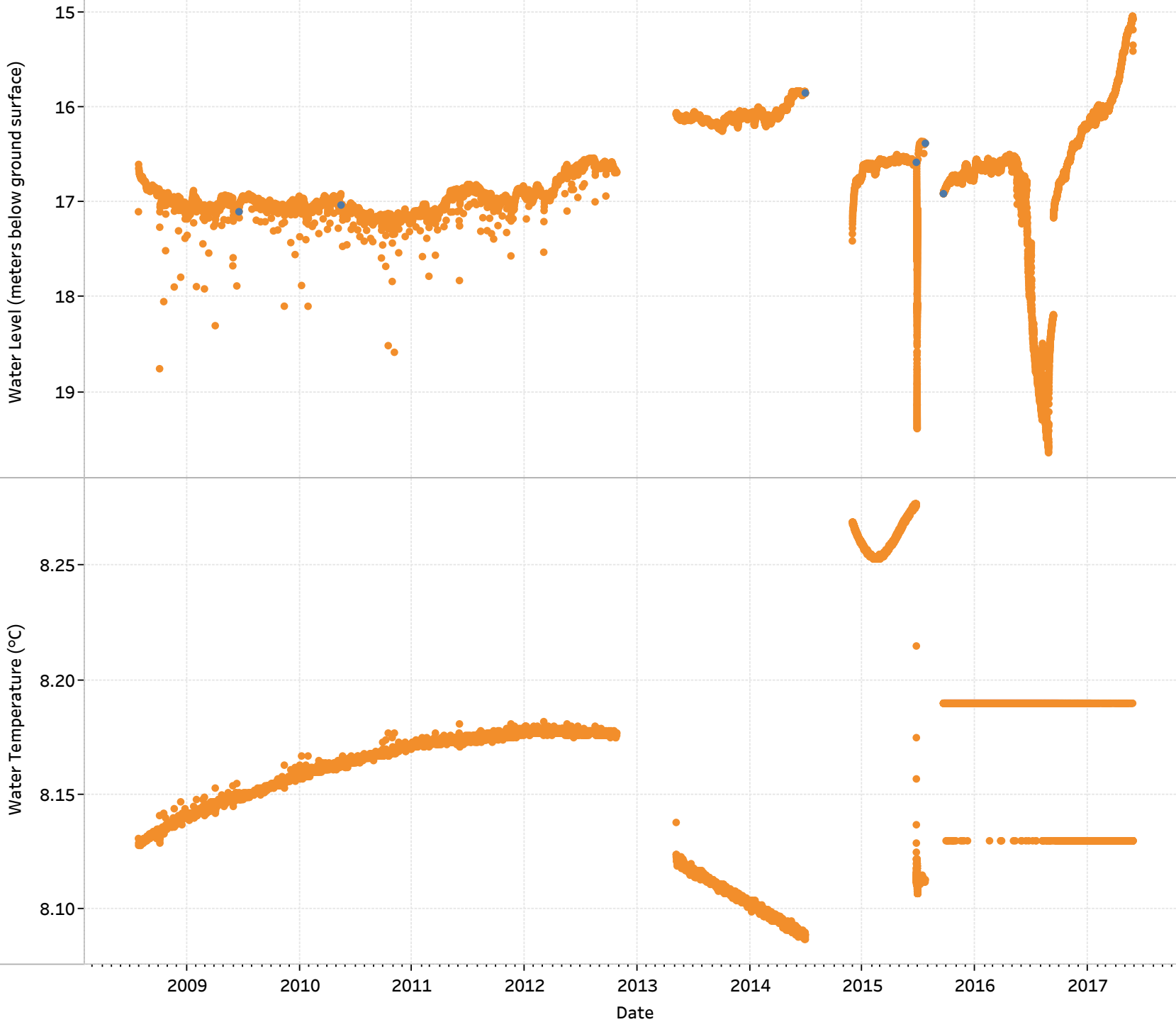

Measurement Type

- Manual data
- Logger data

Well depth (mbgs)

68.2

Depth of Water Level Sensor (mbgs)

45 mbgs



Graphs produced by:

C Waters Consulting



GW SOLUTIONS
ASSESSMENT & PROTECTION OF GROUNDWATER

Water Level & Daily Total Precipitation

Station ID: LLC_VOW_08

Station ID Groundwater
 LLC_VOW_08

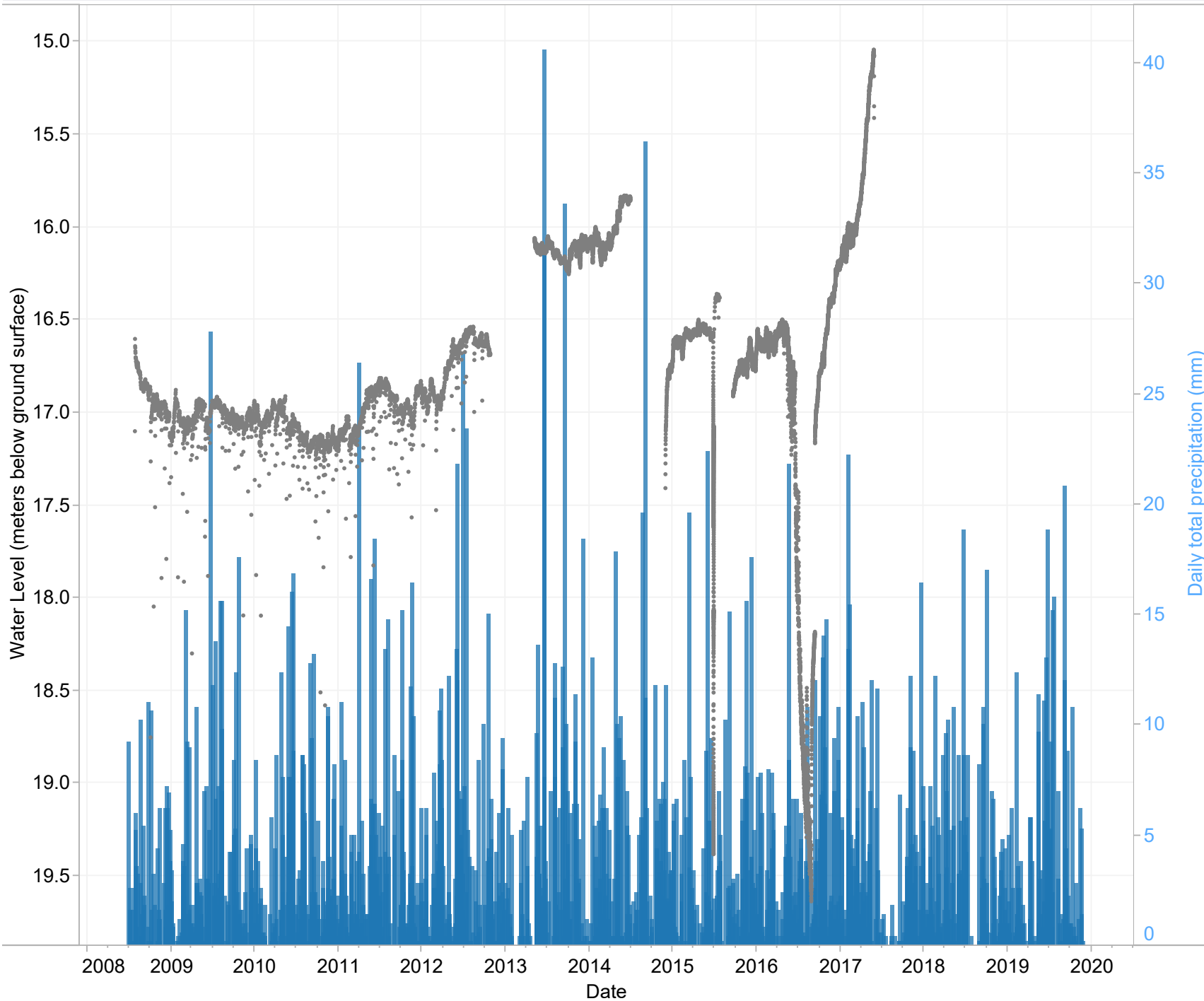

Station ID Legend

- 50818
- LLC_VOW_08

Precipitation	50818	CRANBROOK ▲
Groundwater	LLC_VOW_08	



Graphs produced by:

C Waters
 Consulting



Water Level & Cumulative Precipitation Departure from Average (CPD)

Station ID: LLC_VOW_08

Station ID Groundwater
LLC_VOW_08

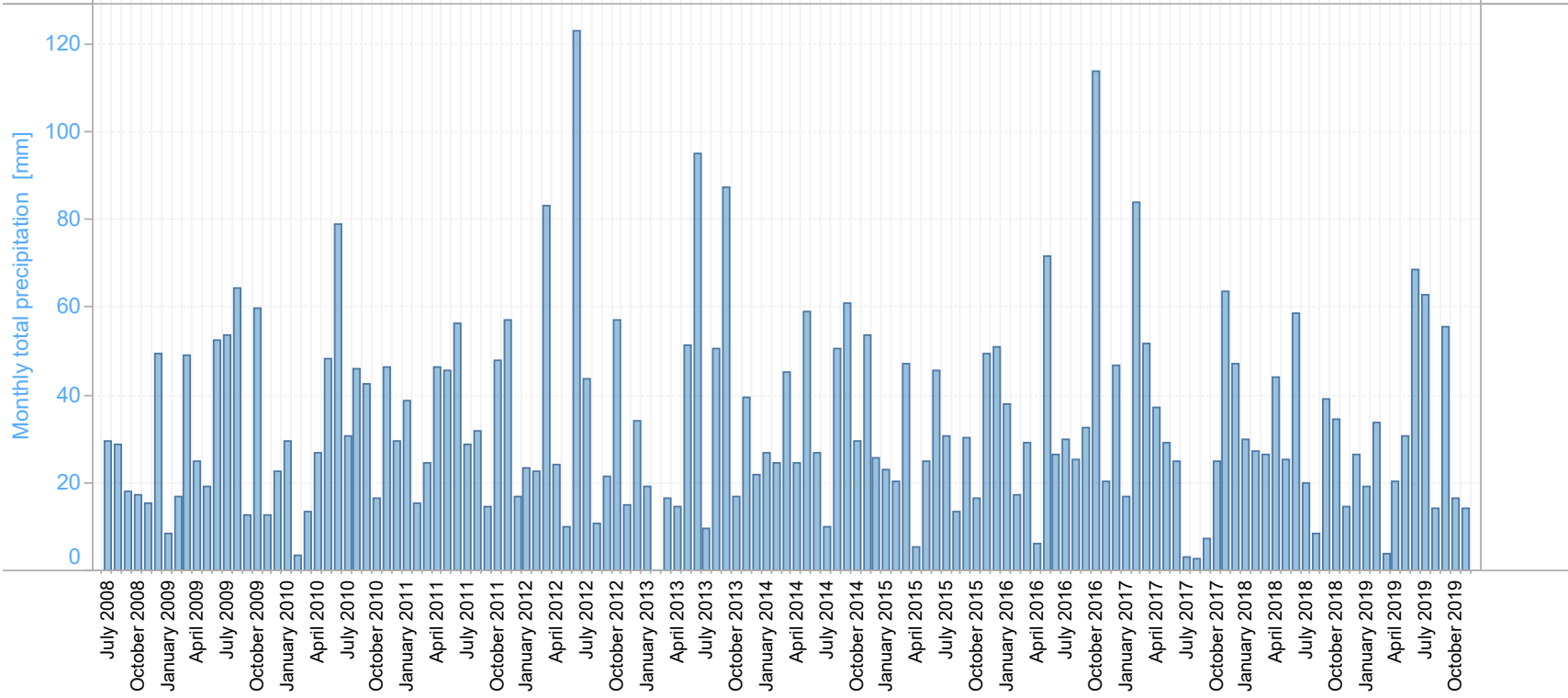
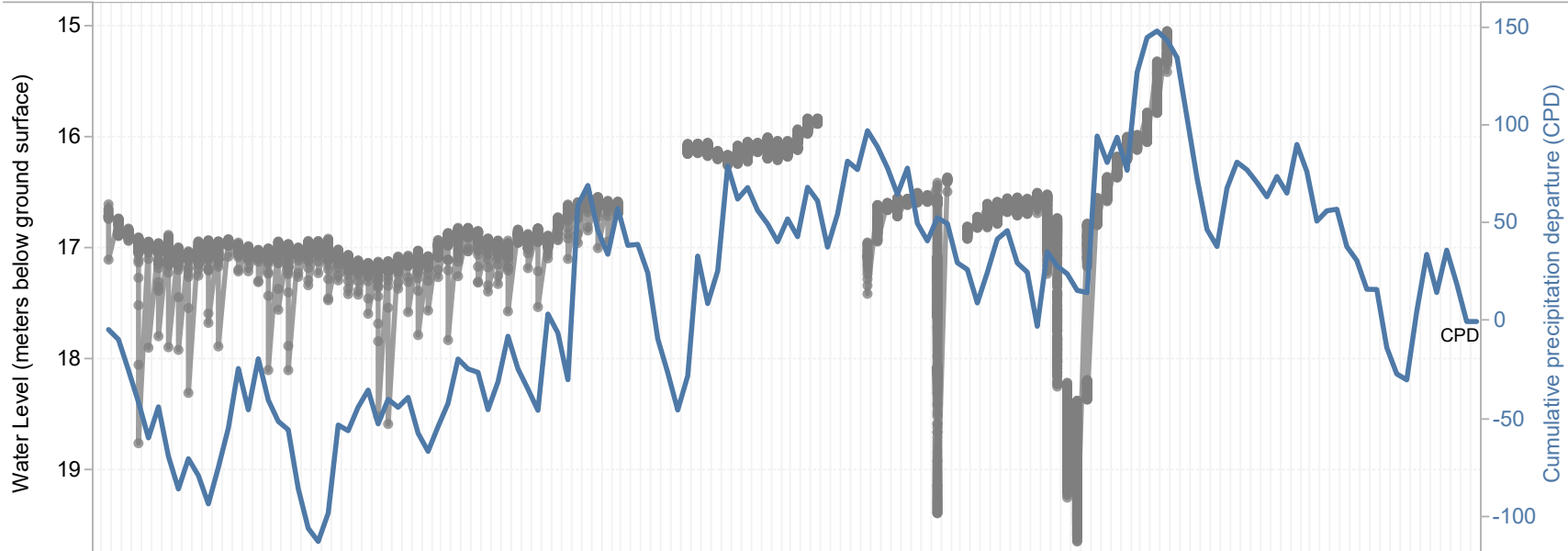

Graphs produced by:

C Waters Consulting



GW SOLUTIONS
ASSESSMENT & PROTECTION OF GROUNDWATER

Historical daily flow data for KOOTENAY RIVER AT FORT STEELE & LLC_VOW_08 (08NG065 & LLC_VOW_08)

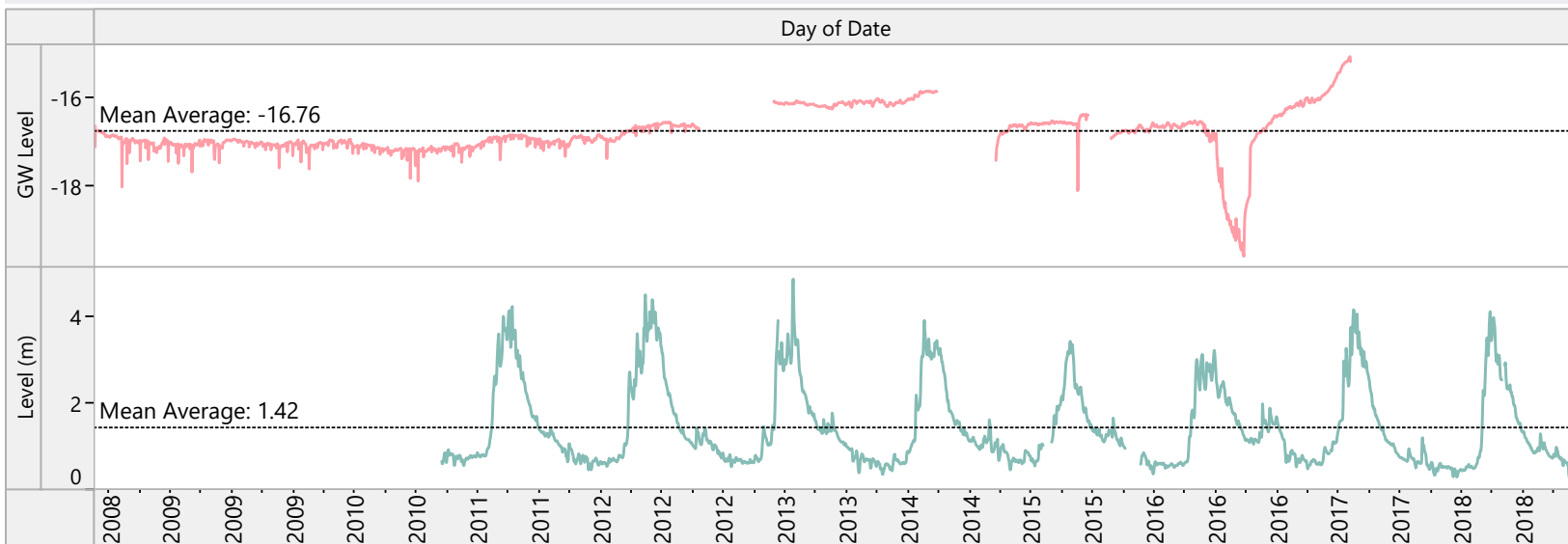

Parameter
Multiple values

Station Status
● ACTIVE
▼ DISCONTINUED

Station ID
08NG065
LLC_VOW_08

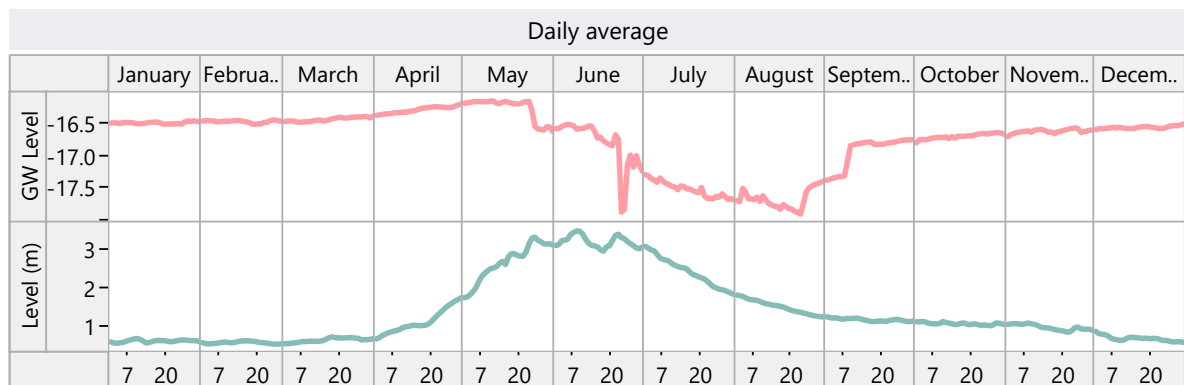
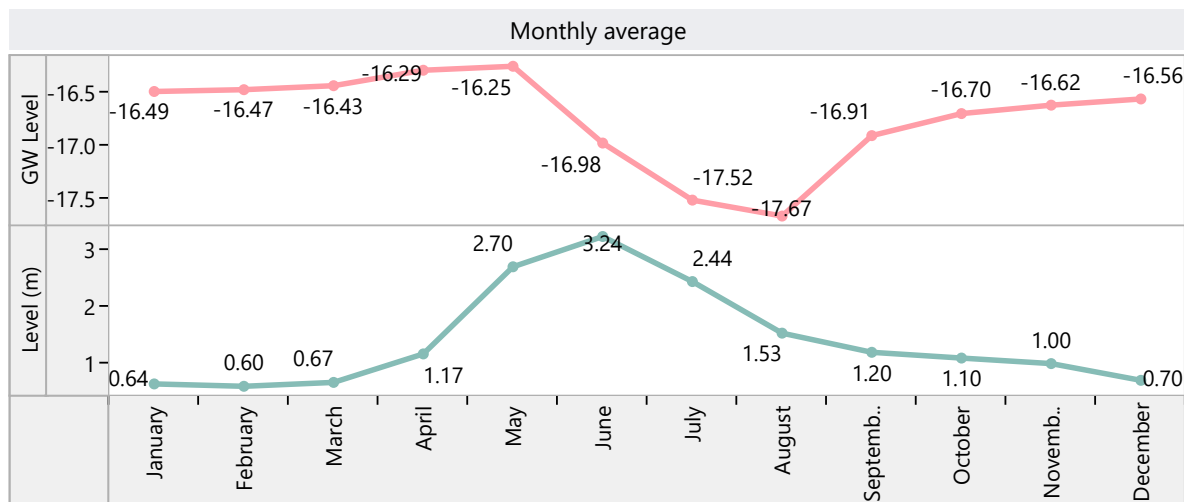
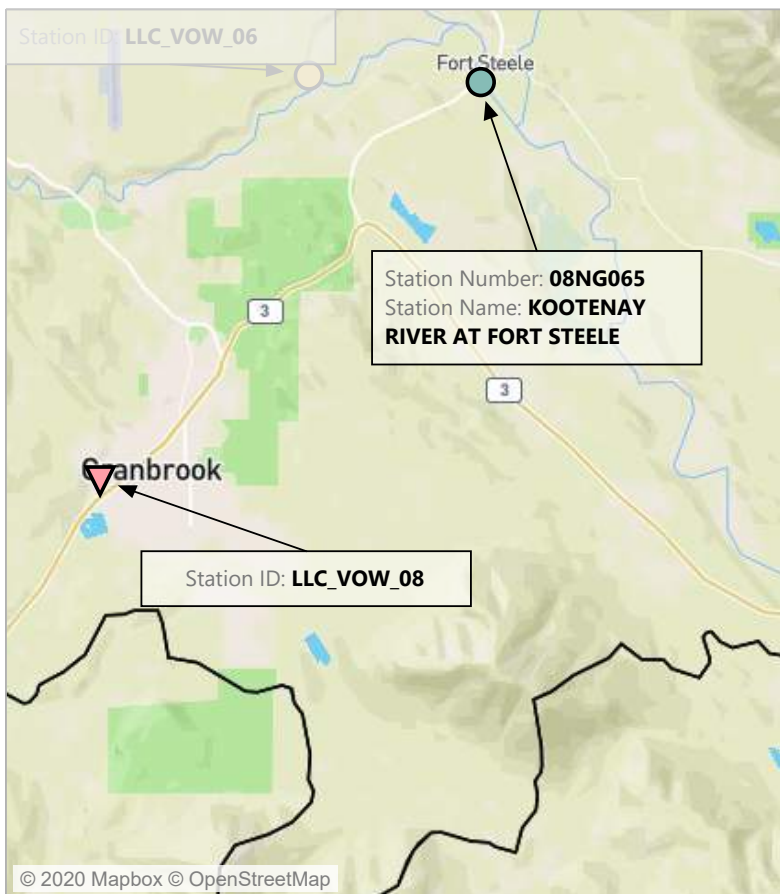

Water Level Yearly Comparison LLC_VOW_08

Station ID
LLC_VOW_08

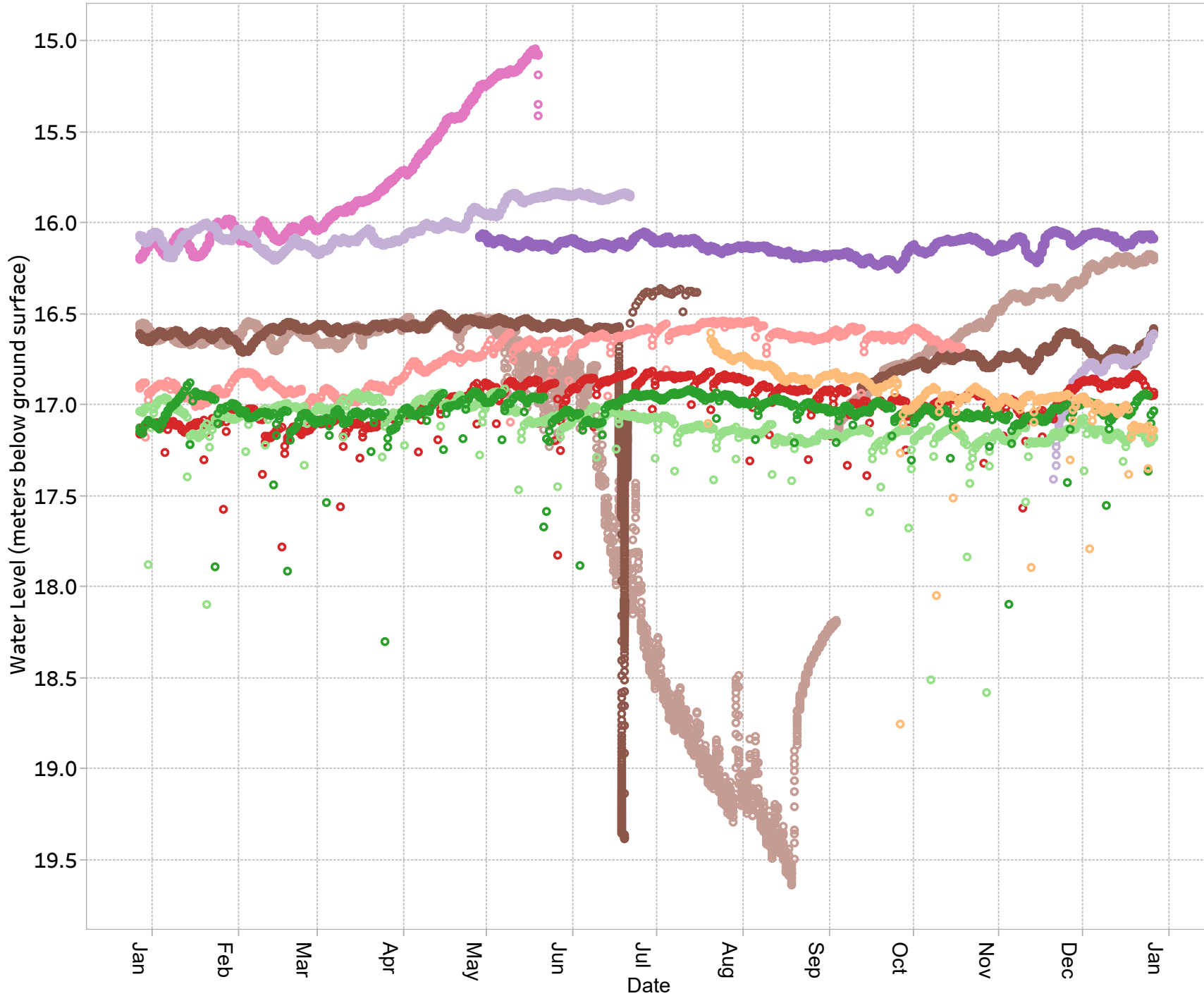

Graphs produced by:



Monitoring Location: VOW_09 - Playmor Junction, Playmor Road.

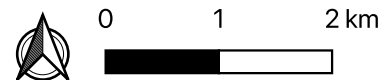
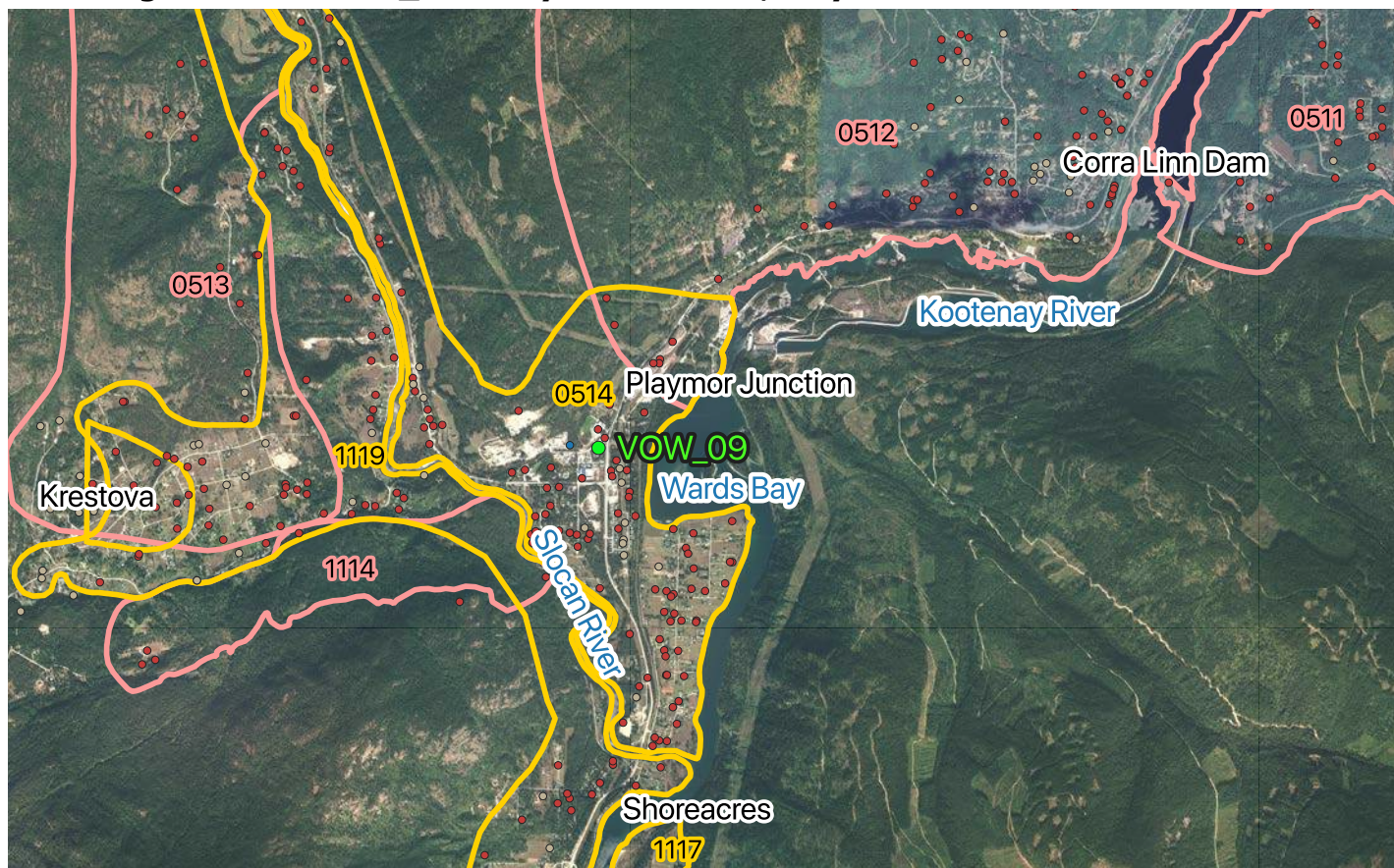

Legend

**Living Lakes Canada
Volunteer Observation Well (VOW)**

- Active

Provincially Mapped Aquifers

- Bedrock Aquifer
- Sand & Gravel Aquifer

Wells registered in GWELLS

- Well Decommissioned
- Well assigned to a Mapped Aquifer
- Well not assigned to a Mapped Aquifer

**Environmental Monitoring System
Groundwater Sampling**

- Spring or Hot Spring
- Well
- Monitoring Well
- Contaminated Site
- Observation Well

Data Sources

- BC Data Catalogue (Groundwater Aquifers, Jun 4 2019; GWELLS, May 9 2019; Environmental Monitoring System, May 29 2019; BC Geographical Names, Dec 13 2019)
- Pacific Climate Impacts Consortium (BC Station Data, Nov 29 2019)
- Google Satellite

Coordinate Reference System: WGS 84 / UTM Zone 11N (EPSG: 32611)

Well Station ID: LLC_VOW_09

Location Description: Playmor Junction, Playmor Road.
Reason for monitoring: Aquifer 514 identified as priority for monitoring in 2009 PGOWN Review and suggested by FLNRORD.

Well Information

Well Tag Number:	32162	Well ID # from owner:	None
Well Plate ID:	None		
Well Stick up (m):	0	EMS #	n/a
Well Depth (m):	43	Latitude:	49.444697
Well Casing:	6" Steel	Longitude:	-117.536647
		Source of Location	Handheld GPS
Top of Screen (mbgs):	41.57 (from downhole camera inspection)	Coordinates:	
Bottom of Screen (mbgs):	unknown		
Confining Layers:	None- Lithology reports topsoils, silts, sands, and gravels.		
Initial Well Use/Reason for well construction:	Water supply well		

Monitoring Information

Monitoring Status: Active
Monitoring Interval: Hourly
Length of Monitoring Record: 2019-09-10 to Current
Data available on BC Real-time Water Data Website? Yes
Water Level Sensor: HOBO MX2001-02 (Range- 30m)
Data Logger Type: HOBO MX 2001
Barometric Pressure Sensor: HOBO MX2001- installed in airspace in well
Water Level Sensor Depth (mbgs): 41.2
Comments: Well is not properly located in GWELLS. Well pump has been removed. A downhole camera inspection was completed on September 23 2019. Downhole inspection shows the top of the screen is at 41.57m bTOC and the well is filled with sediment to 41.73m bTOC. May need to airlift sediment and re-develop well. Top of the casing is flush with ground surface. Well needs to be modified to increase the stick up.

Nearest climate station with a complete record

Climate Network Name: Environment Canada (Canadian Daily Climate Data)
Climate Station Location/Name: Nelson Rixen Creek
Climate Station Number: 1095

Aquifer Information

Aquifer #:	514
Aquifer Material:	Sand and gravel
Aquifer Area (km²):	15
Aquifer Confinement:	Partially confined: The confining layer contains many windows.
Description¹:	Confined glacio-fluvial sand and gravel aquifers underneath till, in between till layers, or underlying glacio-lacustrine deposits (subtype = 4b).
Likelihood of hydraulic connection¹:	Not likely (based on broad regional assessment)
Hydraulic Connection Assessment by LLC²:	Likely connected to the Slocan River
Rational for Hydraulic Connection Assessment by LLC³:	Direction of groundwater flow is towards the Slocan River. Recharge is generally from the upslope bedrock and direct precip, surface water runoff. Aquifer boundaries follow the slocan river and quaternary deposits. Glaciofluvial deposit comprised of sand and gravel. Aquifer is confined with unconfined windows. Depth to water table varies between 1.2 m - 71.3 m

Foot Notes

¹From Provincial aquifer factsheets available at <https://apps.nrs.gov.bc.ca/gwells/aquifers>

²Assessed by Living Lakes Canada. See methods in report.

³Rational for hydraulic connectivity assessment by Living Lakes Canada.



GW SOLUTIONS
ASSESSMENT & PROTECTION OF GROUNDWATER



WELL ID:
LLC_VOW_09

EASTING: 461099
NORTHING: 5477031
DATE COMMENCED: 03-07-1975
DATE COMPLETED: 03-07-1975

LOCATION: Columbia Basin
CONTRACTOR: Unknown
STICK UP (m): 0.00

WELL ID PLATE No.: None
BC WELL TAG No.: 32162
DRILL RIG: Unknown
DRILLER: Unknown
LOGGED BY: Driller

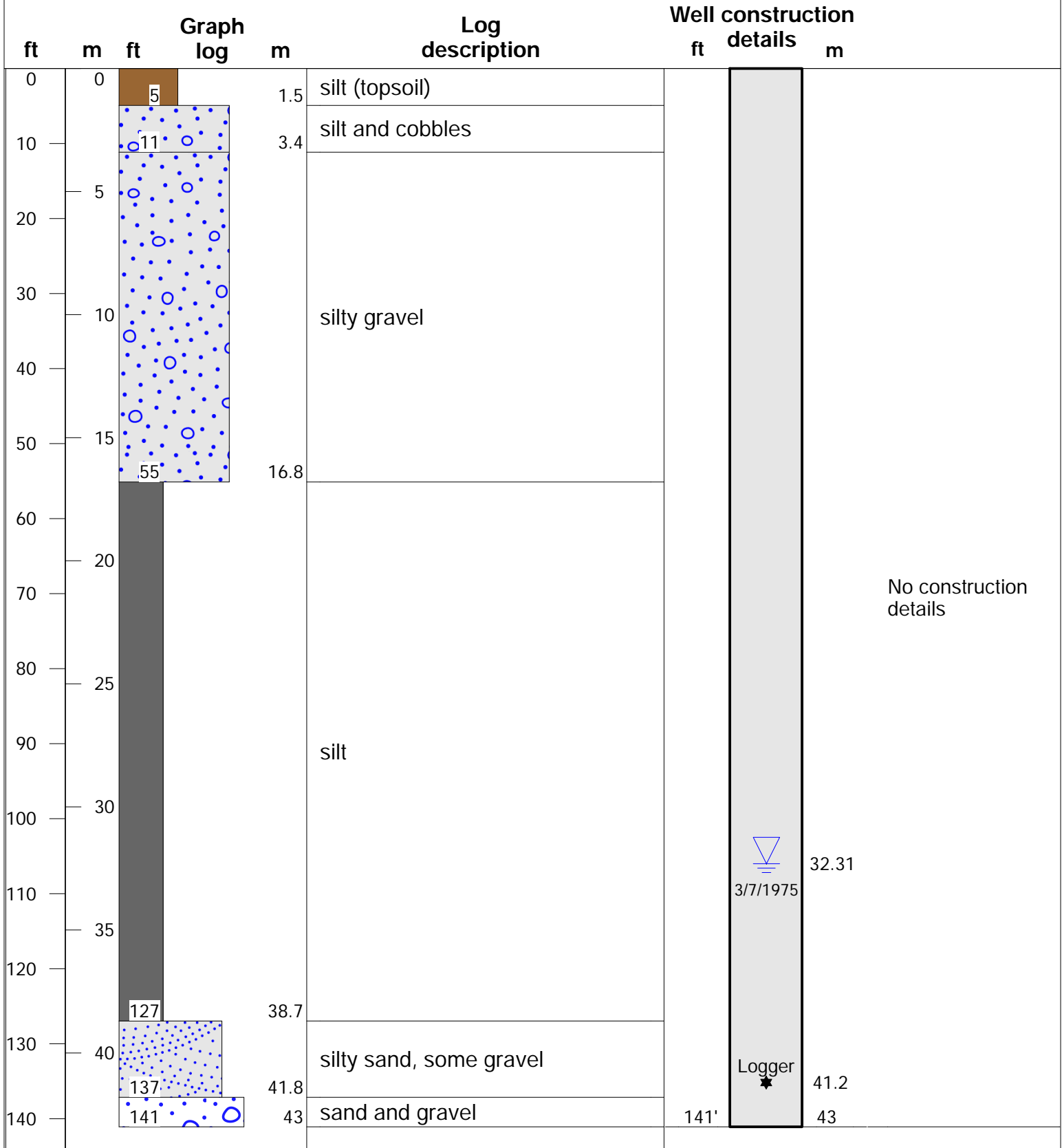

Water Level & Water Temperature Station ID: LLC_VOW_09

Station ID
LLC_VOW_09

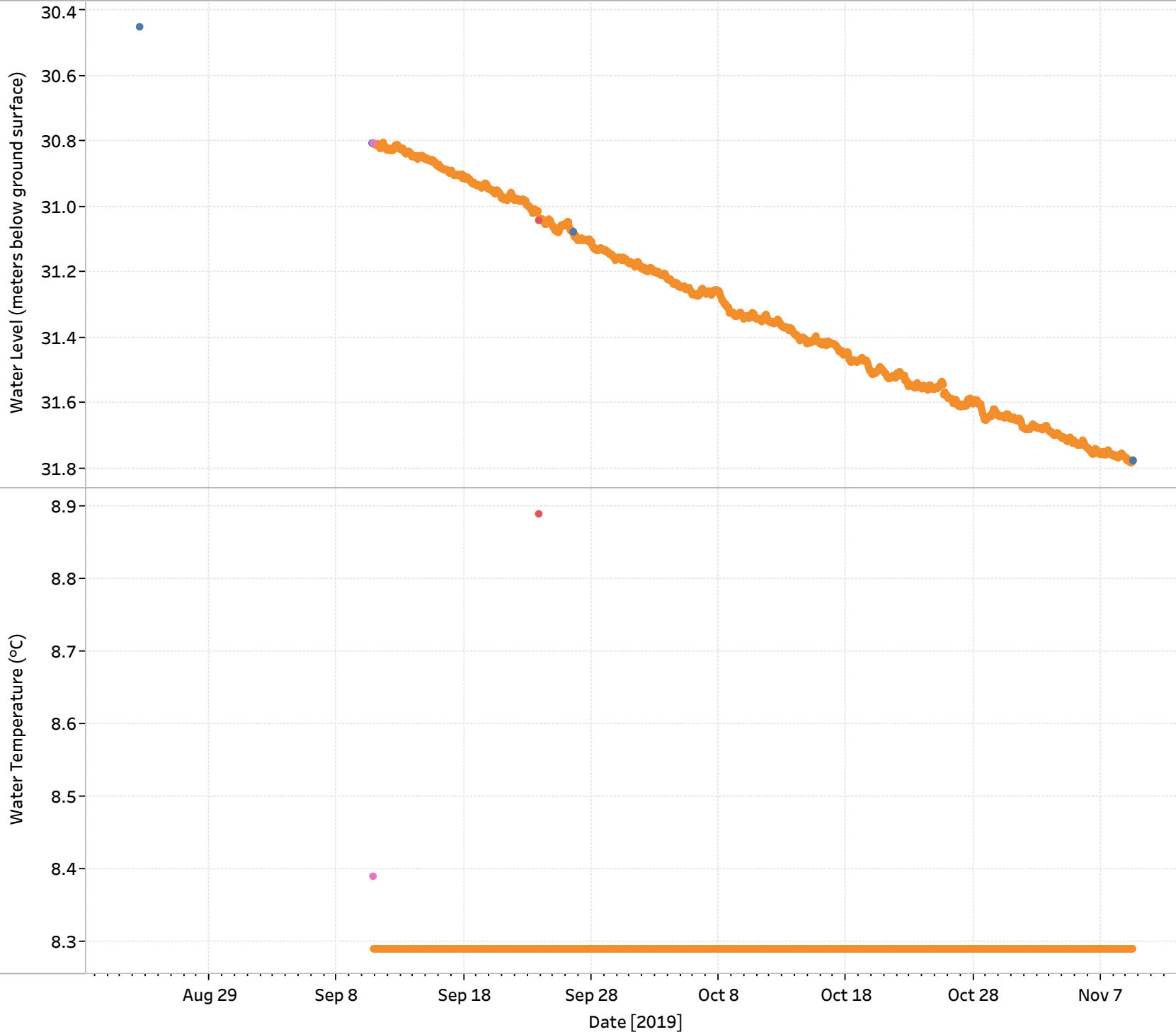

Measurement Type
Outlier
Logger dewatered
Manual data
Logger data

Well depth (mbgs)	43
Depth of Water Level Sensor (mbgs)	41.2 mbgs



Graphs produced by:



Water Level & Daily Total Precipitation

Station ID: LLC_VOW_09

Station ID Groundwater
 LLC_VOW_09

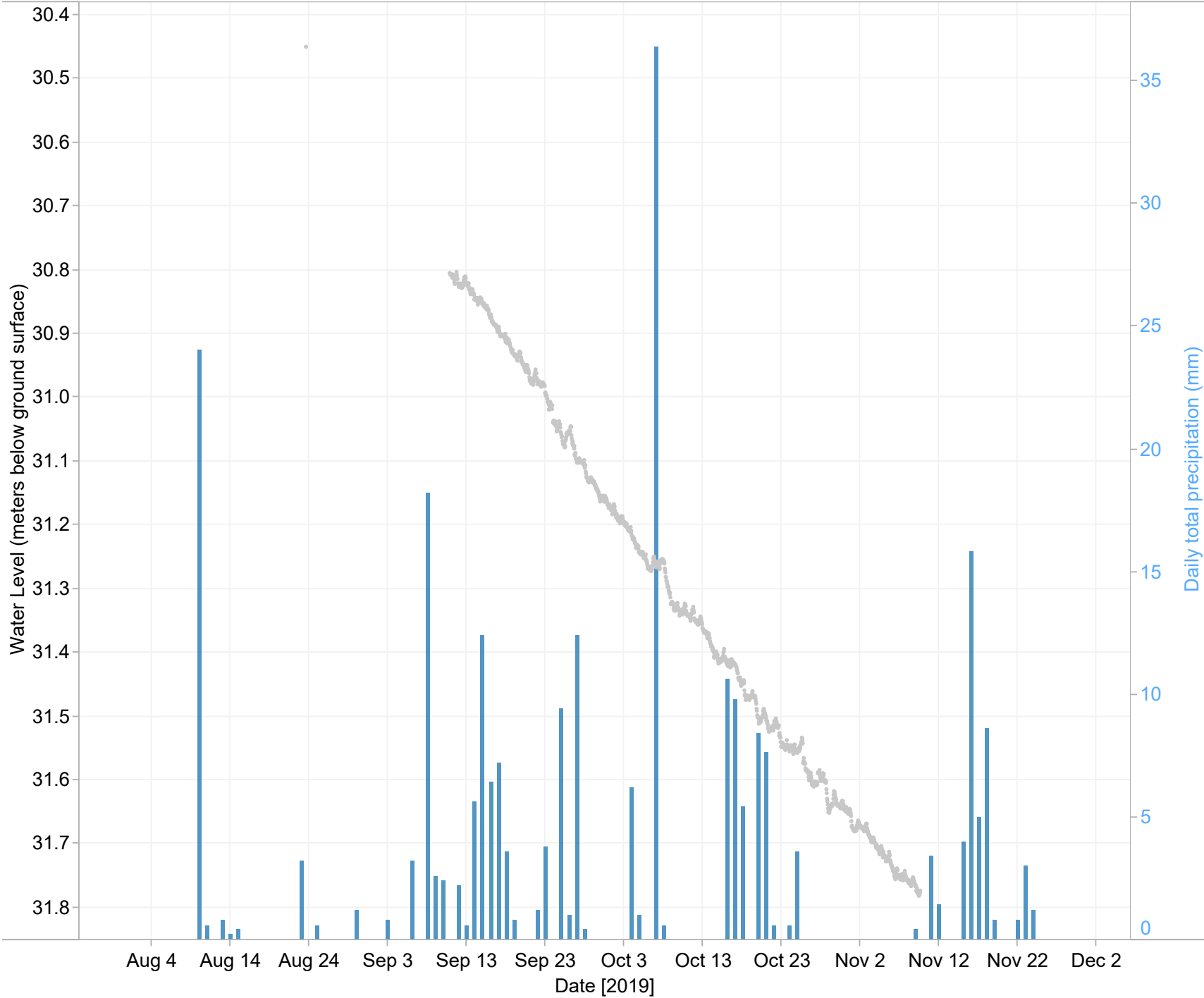

Station ID Legend

- 1095
- LLC_VOW_09

Precipitation	1095	NELSON RIXEN CREEK
Groundwater	LLC_VOW_09	Playmor Junction, Playmor Road.



Graphs produced by:

**C Waters
 Consulting**



GW SOLUTIONS
ASSESSMENT & PROTECTION OF GROUNDWATER

Historical daily flow data for LLC_VOW_09 & SLOCAN RIVER NEAR CRESCENT VALLEY (All)

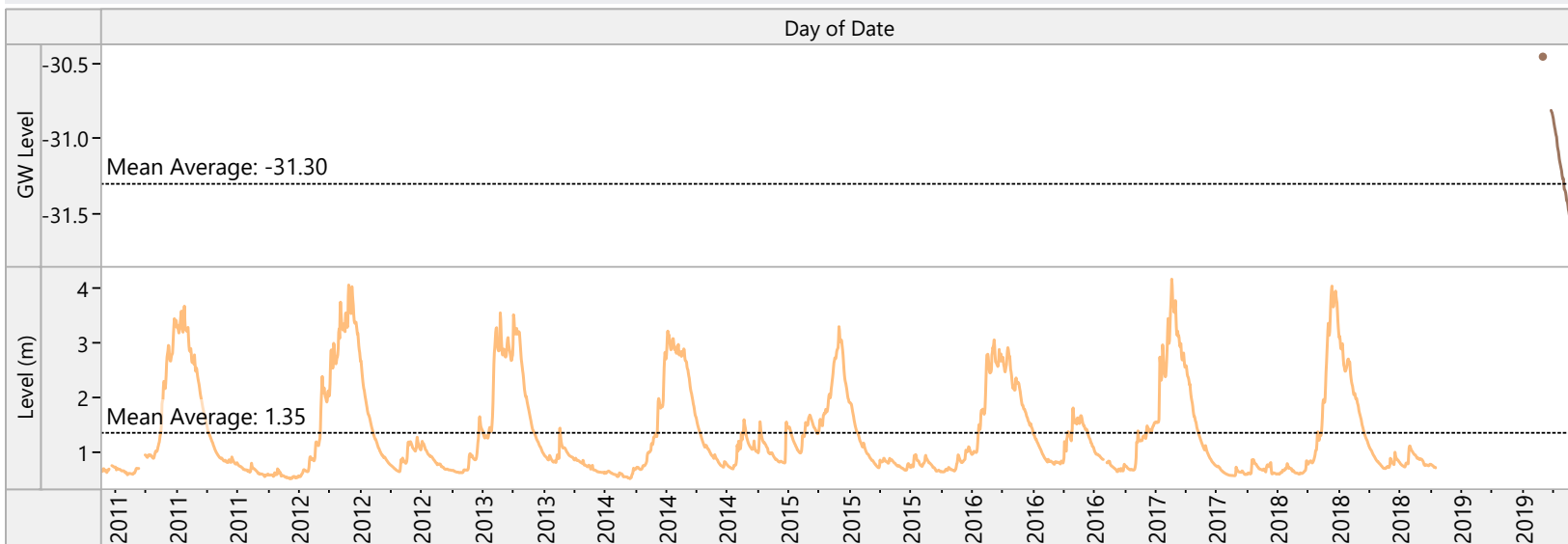

Parameter
Multiple values

Station Status
● ACTIVE
▼ DISCONTINUED

Station ID
08NJ013
LLC_VOW_09

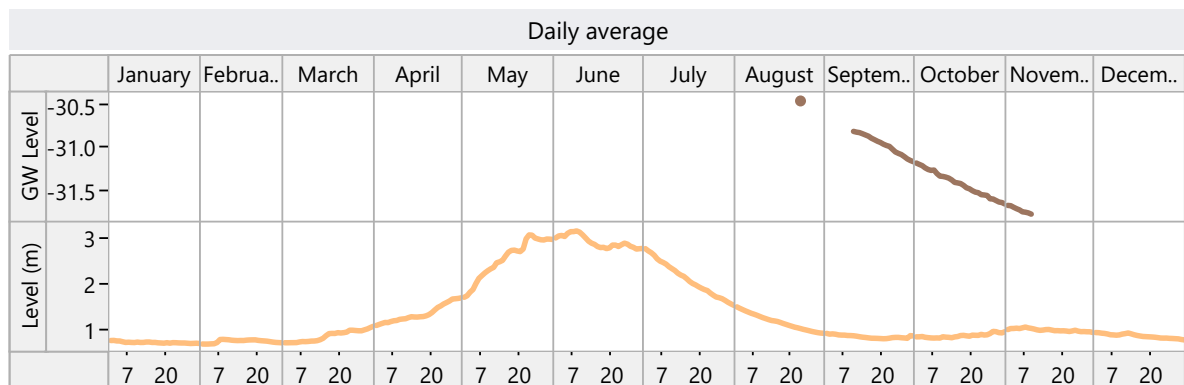
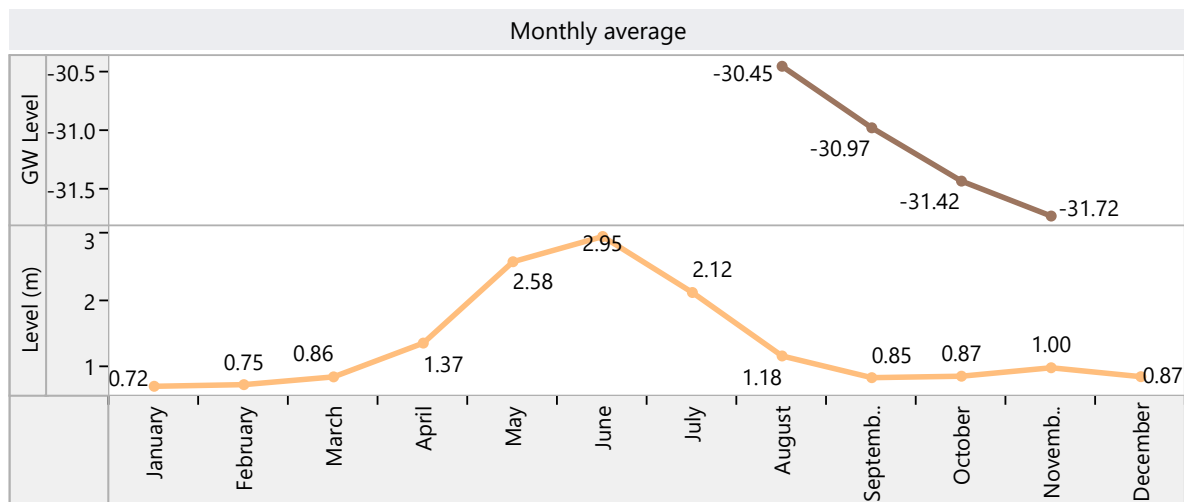
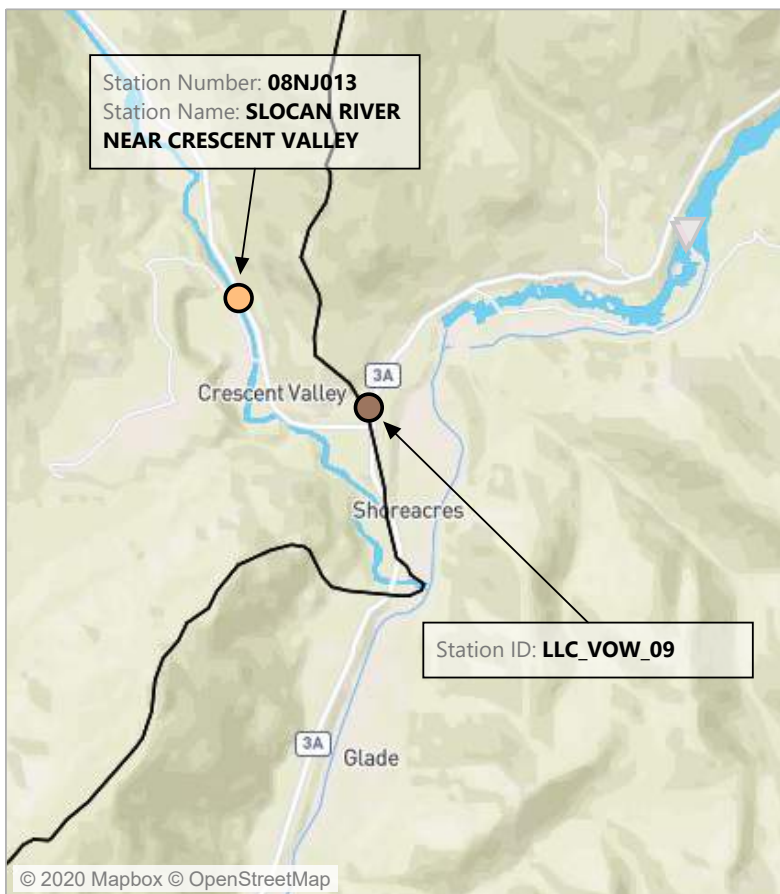

Monitoring Locations: VOW_10 & VOW_11 - Windermere, Windermere Loop Road.

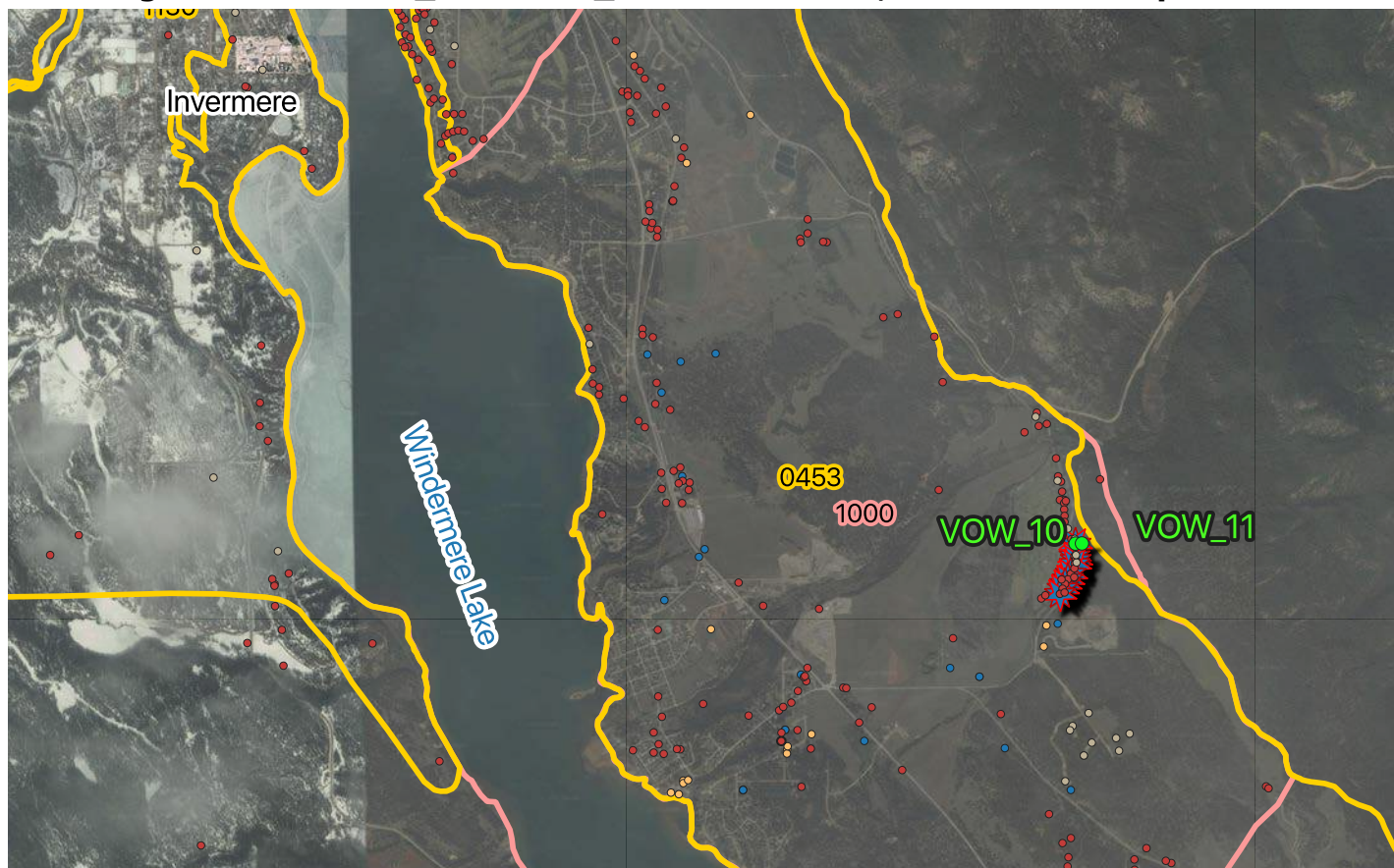

Legend

Living Lakes Canada

Volunteer Observation Well (VOW)

- Active

Provincially Mapped Aquifers

- Bedrock Aquifer
- Sand & Gravel Aquifer

Wells registered in GWELLS

- Well Decommissioned
- Well assigned to a Mapped Aquifer
- Well not assigned to a Mapped Aquifer
- ✳ Locations Corrected

Environmental Monitoring System

Groundwater Sampling

- Spring or Hot Spring
- Well
- Monitoring Well
- Contaminated Site
- Observation Well

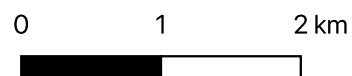

Data Sources

- BC Data Catalogue (Groundwater Aquifers, Jun 4 2019; GWELLS, May 9 2019; Environmental Monitoring System, May 29 2019; BC Geographical Names, Dec 13 2019)
- Pacific Climate Impacts Consortium (BC Station Data, Nov 29 2019)
- Google Satellite

Coordinate Reference System: WGS 84 / UTM Zone 11N (EPSG: 32611)

Well Station ID: LLC_VOW_10

Location Description: Windermere, Windermere Loop Road -West side of road.
Reason for monitoring: Citizens/landowners concerned about wells going dry in area.

Well Information

Well Tag Number:	66814	Well ID # from owner:	n/a
Well Plate ID:	n/a		
Well Stick up (m):	0.244	EMS #	n/a
Well Depth (m):	47.9	Latitude:	50.470698
Well Casing:	6" Steel	Longitude:	-115.945318
		Source of Location	
Top of Screen (mbgs):	No screen.	Coordinates:	
Bottom of Screen (mbgs):	No screen.		Handheld GPS
Confining Layers:	Clay and Gravel (0 to 47.7 m)		
Initial Well Use/Reason for well construction:	Private domestic water supply well		

Monitoring Information

Monitoring Status: Active
Monitoring Interval: Hourly

Length of Monitoring Record: 2018-10-24 to Current

Data available on BC Real-time Water Data Website? Yes
Water Level Sensor: HOBO MX2001-02 (Range- 30m)

Data Logger Type: HOBO MX 2001

Barometric Pressure Sensor: HOBO MX2001- installed in airspace at top of well

Water Level Sensor Depth (mbgs): 47.2

Comments: Well locations in this area are incorrectly mapped in GWELLS. This well was formerly a domestic water supply well and pump has now been removed. Owner drilled a new well in 2017, because this well was going dry in 2016. For comparison to precipitation data, should check Ministry of Transport and Infrastructure and Ministry of Forests, Lands, and Natural Resources Operations and Rural Development Climate Station data that may be more representative of local conditions.

Nearest climate station with a complete record

Climate Network Name: Environment Canada (Canadian Daily Climate Data)
Climate Station Location/Name: GOLDEN A
Climate Station Number: 1364

Aquifer Information

Aquifer #:	453
Aquifer Material:	Sand and gravel
Aquifer Area (km²):	65
Aquifer Confinement:	Mostly confined: Of 130 wells displaying a full well log, 23 show no confining layer.
Description¹:	Confined glacio-fluvial sand and gravel aquifers underneath till, in between till layers, or underlying glacio-lacustrine deposits (subtype = 4b).
Likelihood of hydraulic connection¹:	Not likely (based on broad regional assessment)
Hydraulic Connection Assessment by LLC²:	Not assessed.
Rational for Hydraulic Connection Assessment by LLC³:	Not assessed.

Foot Notes

¹From Provincial aquifer factsheets available at <https://apps.nrs.gov.bc.ca/gwells/aquifers>

²Assessed by Living Lakes Canada. See methods in report.

³Rational for hydraulic connectivity assessment by Living Lakes Canada.



GW SOLUTIONS
ASSESSMENT & PROTECTION OF GROUNDWATER



WELL ID:
LLC_VOW_10

EASTING: 574845

NORTHING: 5591499

DATE COMMENCED: 06 April, 1996

DATE COMPLETED: 06 April, 1996

LOCATION: Columbia Basin

CONTRACTOR: Thompson Drilling

STICK UP (m): 0.30

WELL ID PLATE No.:

BC WELL TAG No.: 66814

DRILL RIG: Cable Tool

DRILLER: Dennis Thompson

LOGGED BY: Driller

Graph log		Log description	Well construction details	
ft	m		ft	m
0	0	clay and gravel		
10				
	5			
20				
	10			
30				
	15			
40				
	20			
50				
	25			
60				
	30			
70				
	35			
80				
	40			
90				
	45			
100			127'	38.7
110				
120				
130				
140				
150				
157	47.9			

Steel Casing
0.188" thick

Steel Casing
0.250' thick

4/6/1996
Logger

Water Level & Water Temperature Station ID: LLC_VOW_10

Station ID
LLC_VOW_10

Measurement Type
Manual data
Logger data

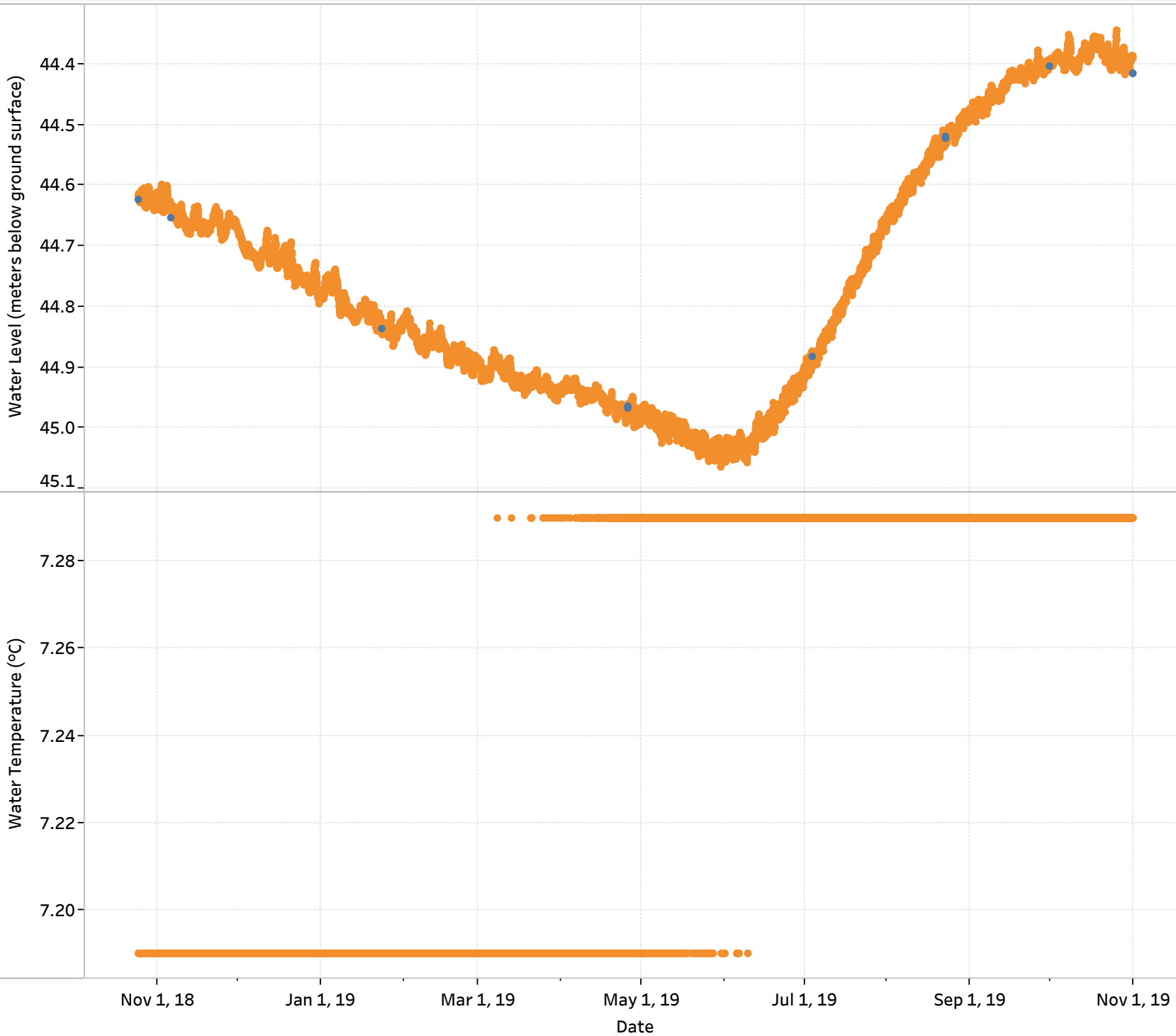

Well depth (mbgs)

47.9

Depth of Water Level Sensor (mbgs)

47.2 mbgs



Graphs produced by:

C Waters Consulting



GW SOLUTIONS
ASSESSMENT & PROTECTION OF GROUNDWATER

Water Level & Daily Total Precipitation

Station ID: LLC_VOW_10

Station ID Groundwater
LLC_VOW_10

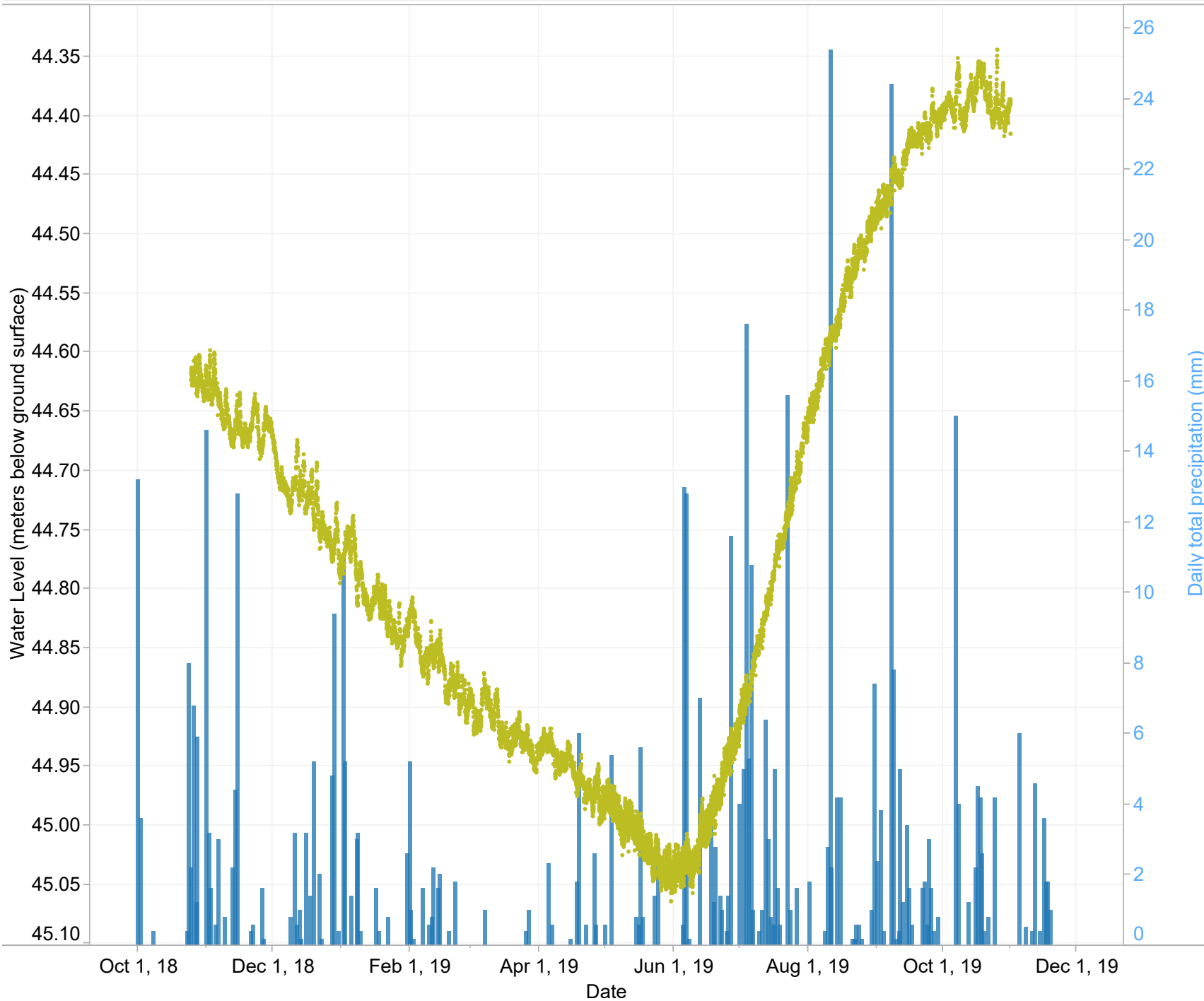

Station ID Legend
■ 1364
■ LLC_VOW_10

Precipitation	1364	GOLDEN A
Groundwater	LLC_VOW_10	Windermere, Windermere Loop Road -West side of road.



Graphs produced by:

C Waters
Consulting



GW SOLUTIONS
ASSESSMENT & PROTECTION OF GROUNDWATER

Water Level & Cumulative Precipitation Departure from Average (CPD)

Station ID: LLC_VOW_10

Station ID Groundwater
LLC_VOW_10

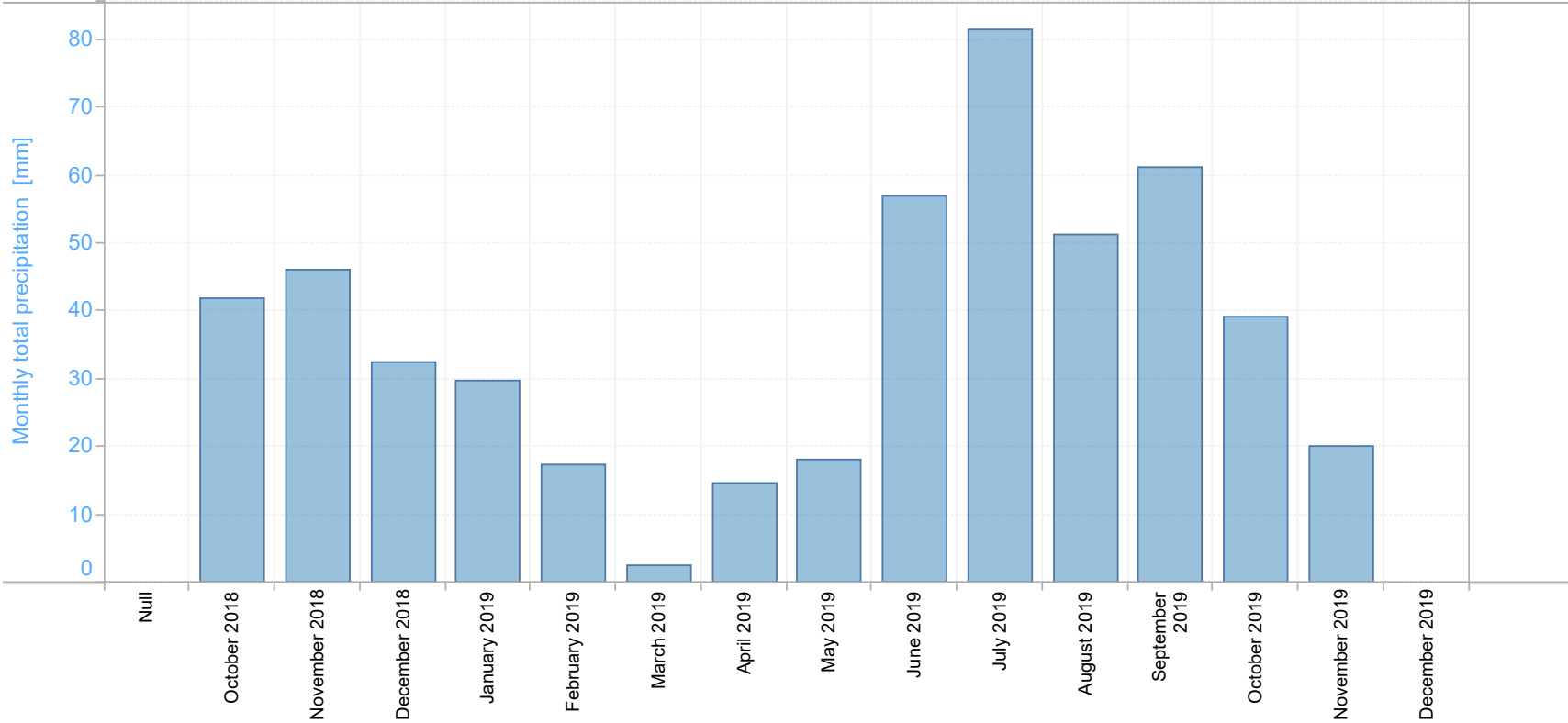
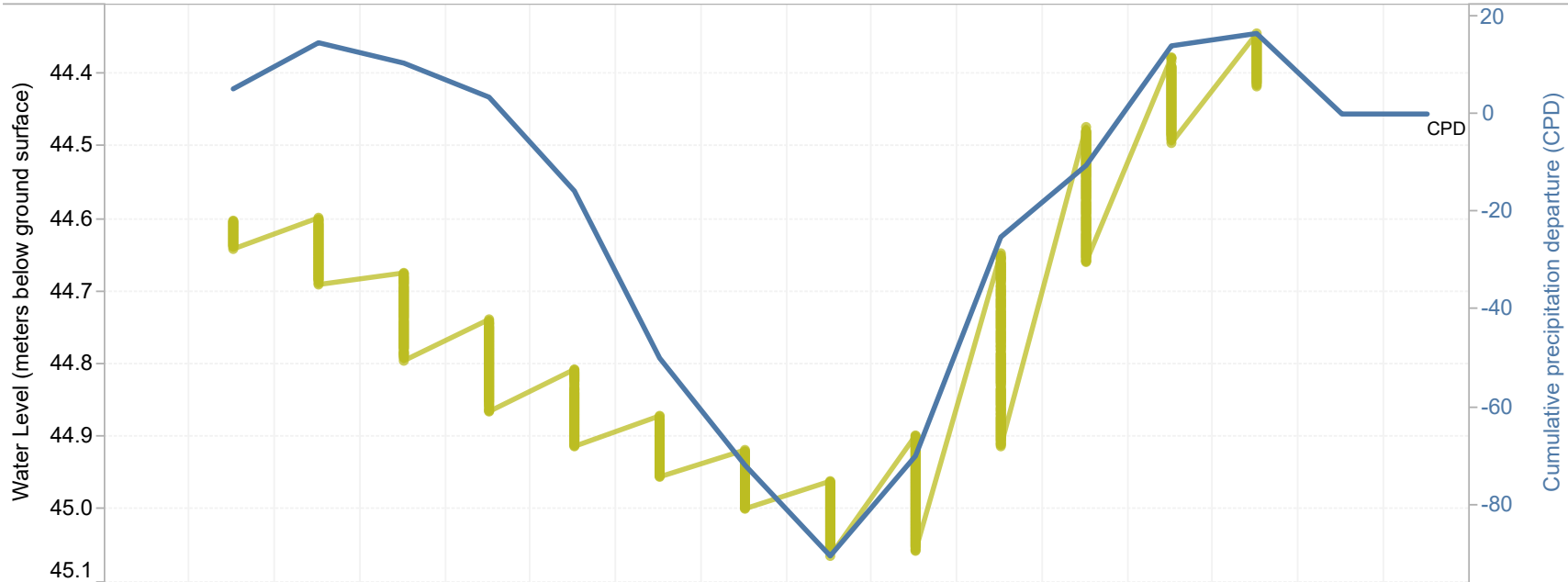

Graphs produced by:

C Waters Consulting



Historical daily flow data for COLUMBIA RIVER AT ATHALMER & LLC_VOW_10 (All)

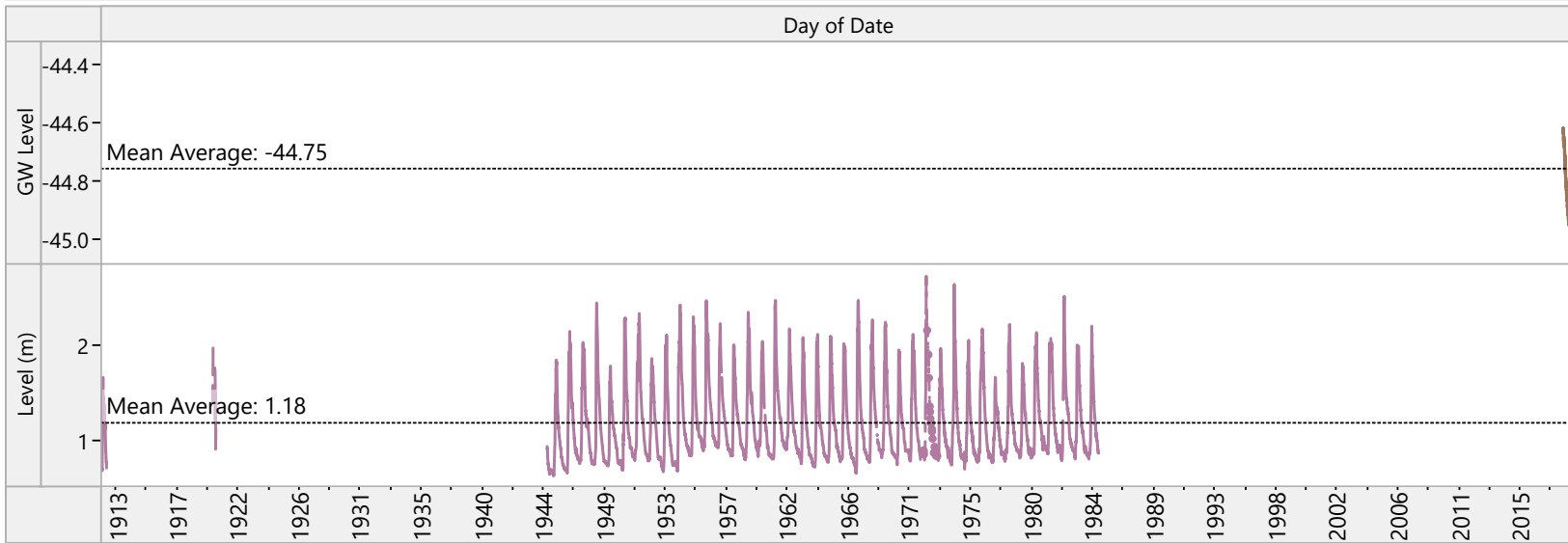

Parameter
Multiple values

Station Status
● ACTIVE
▼ DISCONTINUED

Station ID
■ 08NA004
■ LLC_VOW_10

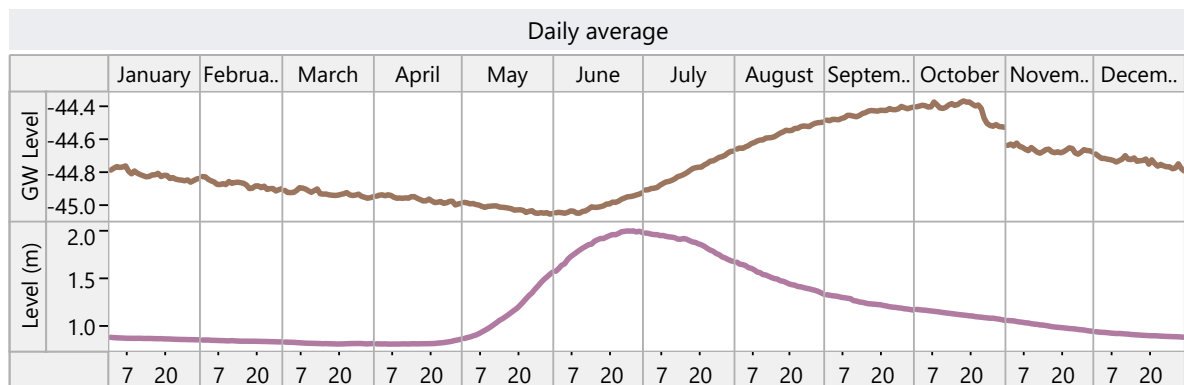
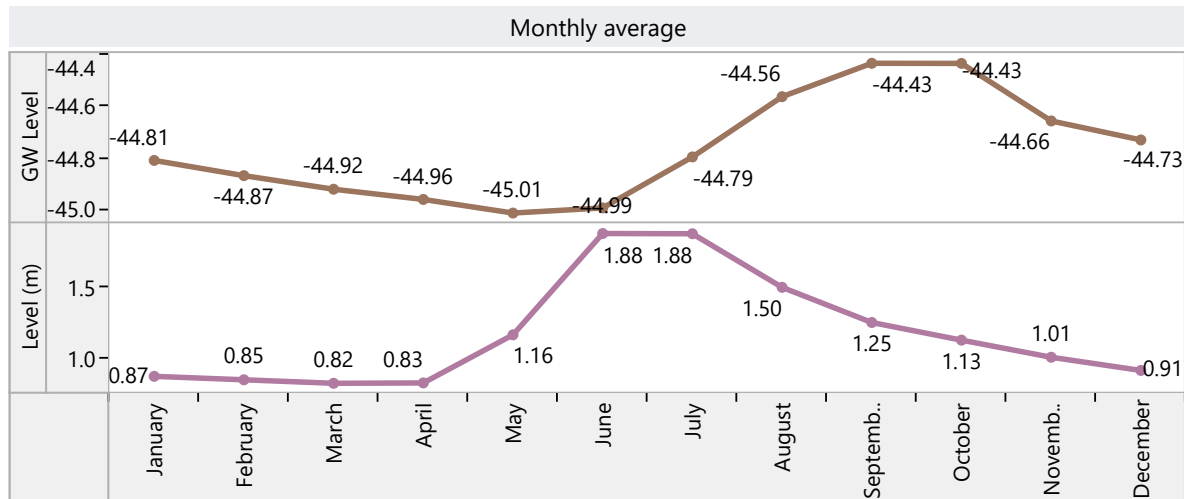
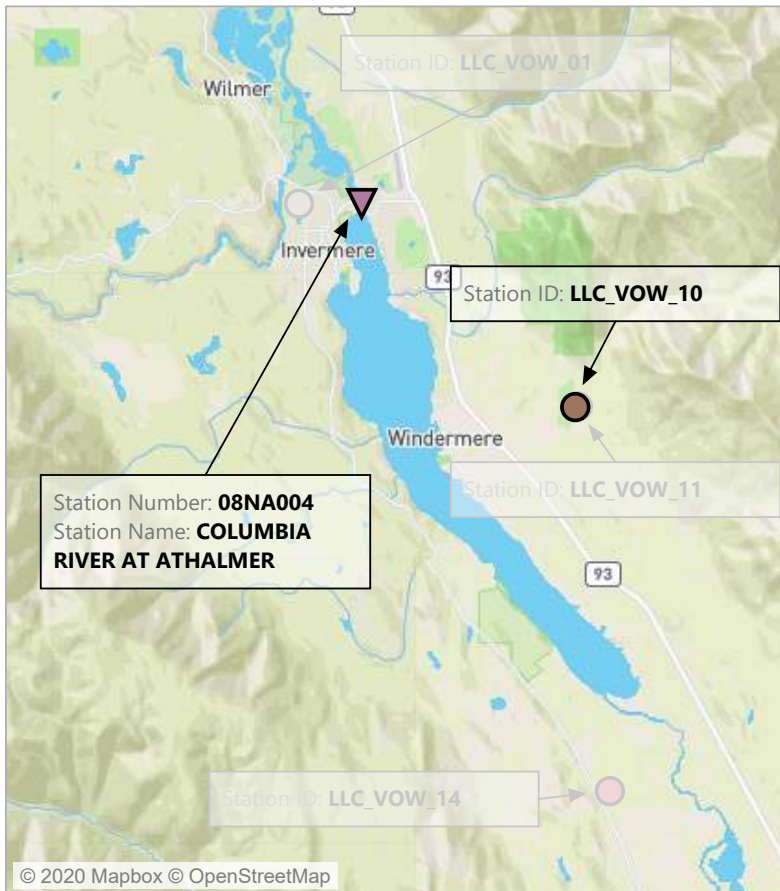

Well Station ID: LLC_VOW_11

Location Description: Windermere, Windermere Loop Road - East side of road.

Reason for monitoring: Citizens/landowners concerned about wells going dry in area.

Well Information

Well Tag Number:	Not registered.	Well ID # from owner:	n/a
Well Plate ID:	None		
Well Stick up (m):	0.762	EMS #	n/a
	68.6 (measured with water level tape; difficult to get accurate measurement because bottom is soft)	Latitude:	50.470833
Well Depth (m):	soft)	Longitude:	-115.944444
Well Casing:	6" Steel	Source of Location Coordinates:	
Top of Screen (mbgs):	Assumed no screen.		
Bottom of Screen (mbgs):	Assumed no screen.		Handheld GPS
Confining Layers:	No lithology information available for this well.		
Initial Well Use/Reason for well construction:	Private domestic water supply well		

Monitoring Information

Monitoring Status:	Active
Monitoring Interval:	Hourly
Length of Monitoring Record:	2018-10-24 to Current
Data available on BC Real-time Water Data Website?	Yes
Water Level Sensor:	HOBO MX2001-02 (Range- 30m)
Data Logger Type:	HOBO MX 2001
Barometric Pressure Sensor:	HOBO MX2001- installed in airspace at top of well
Water Level Sensor Depth (mbgs):	67

Comments: Well locations in this area are incorrectly mapped in GWELLS. Well was drilled as a water supply well, but never used as a water supply. No pump in well. Well located east of VOW_10 on the east side of Windermere Loop Road. For comparison to precipitation data, should check Ministry of Transport and Infrastructure and Ministry of Forests, Lands, and Natural Resources Operations and Rural Development Climate Station data that may be more representative of local conditions.

Nearest climate station with a complete record

Climate Network Name:	Environment Canada (Canadian Daily Climate Data)
Climate Station Location/Name:	GOLDEN A
Climate Station Number:	1364

Aquifer Information

Aquifer #:	Asummed to be in Aquifer 453 due to similar water levels as LLC_VOW_10.
Aquifer Material:	Sand and gravel
Aquifer Area (km²):	65
Aquifer Confinement:	Mostly confined: Of 130 wells displaying a full well log, 23 show no confining layer.
Description¹:	Confined glacio-fluvial sand and gravel aquifers underneath till, in between till layers, or underlying glacio-lacustrine deposits (subtype = 4b).
Likelihood of hydraulic connection¹:	Not likely (based on broad regional assessment)
Hydraulic Connection Assessment by LLC²:	Not assessed.
Rational for Hydraulic Connection Assessment by LLC³:	Not assessed.

Foot Notes

¹From Provincial aquifer factsheets available at <https://apps.nrs.gov.bc.ca/gwells/aquifers>

²Assessed by Living Lakes Canada. See methods in report.

³Rational for hydraulic connectivity assessment by Living Lakes Canada.

Water Level & Water Temperature Station ID: LLC_VOW_11

Station ID
LLC_VOW_11

Measurement Type

- Manual data
- Logger data

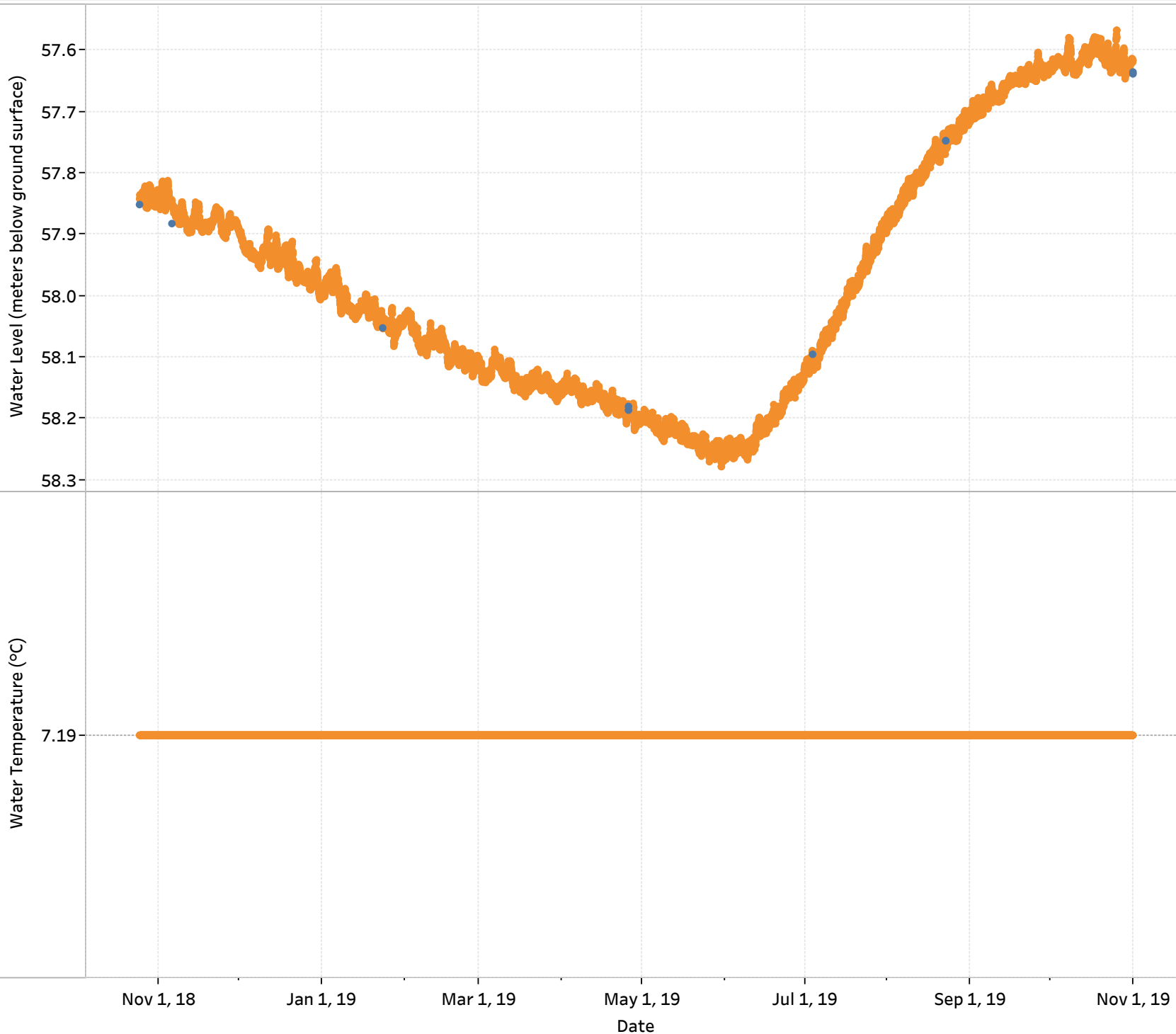

Well depth (mbgs)

68.6 (measured with water level tape; difficult to get ..

Depth of Water Level Sensor (mbgs)

67 mbgs



Graphs produced by:

C Waters Consulting



GW SOLUTIONS
ASSESSMENT & PROTECTION OF GROUNDWATER

Water Level & Daily Total Precipitation

Station ID: LLC_VOW_11

Station ID Groundwater
 LLC_VOW_11

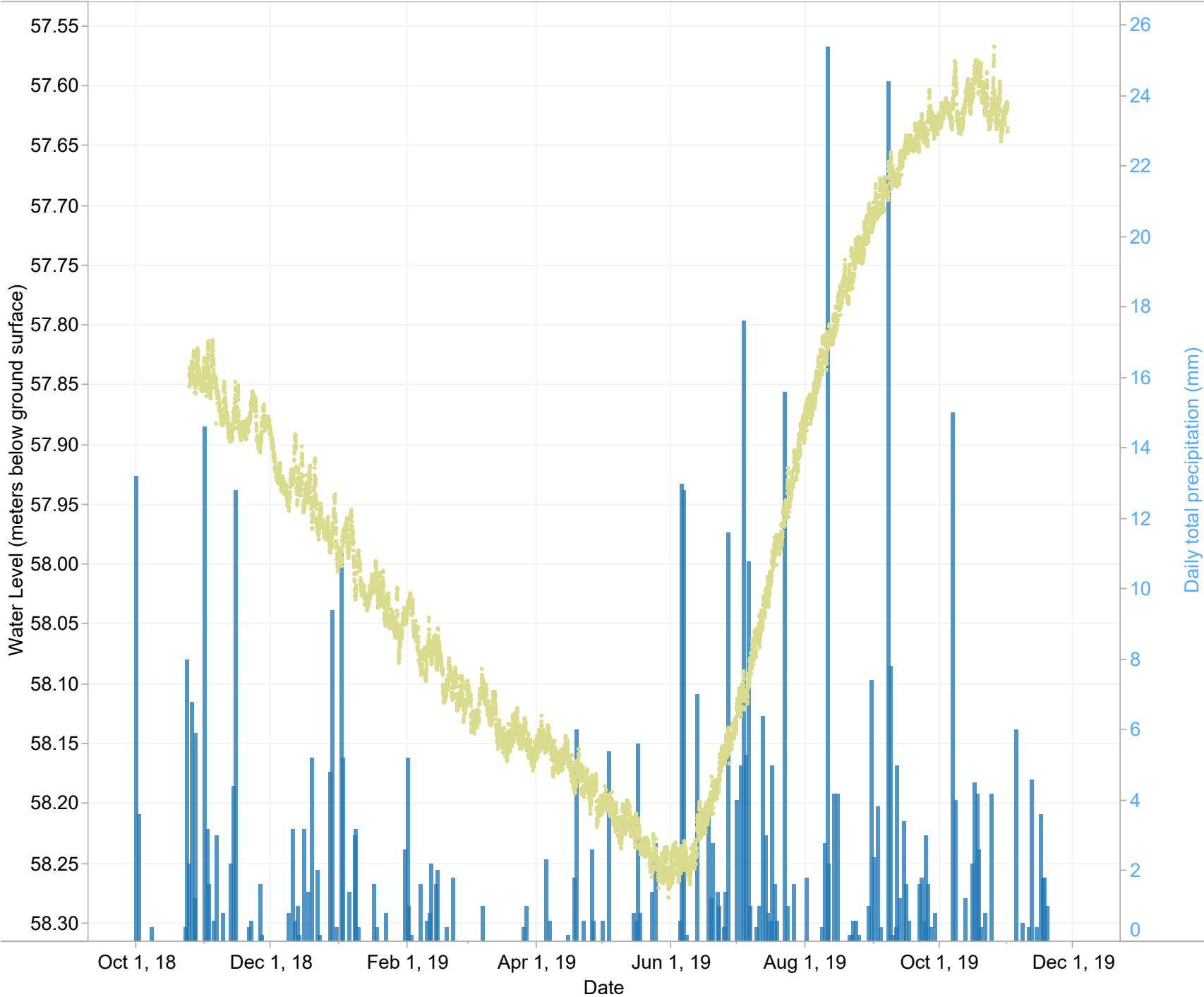

Station ID Legend
 1364
 LLC_VOW_11

Precipitation	1364	GOLDEN A
Groundwater	LLC_VOW_11	Windermere, Windermere Loop Road - East side of road.



Graphs produced by:

C Waters Consulting



GW SOLUTIONS
 ASSESSMENT & PROTECTION OF GROUNDWATER

Water Level & Cumulative Precipitation Departure from Average (CPD)

Station ID: LLC_VOW_11

Station ID Groundwater
LLC_VOW_11

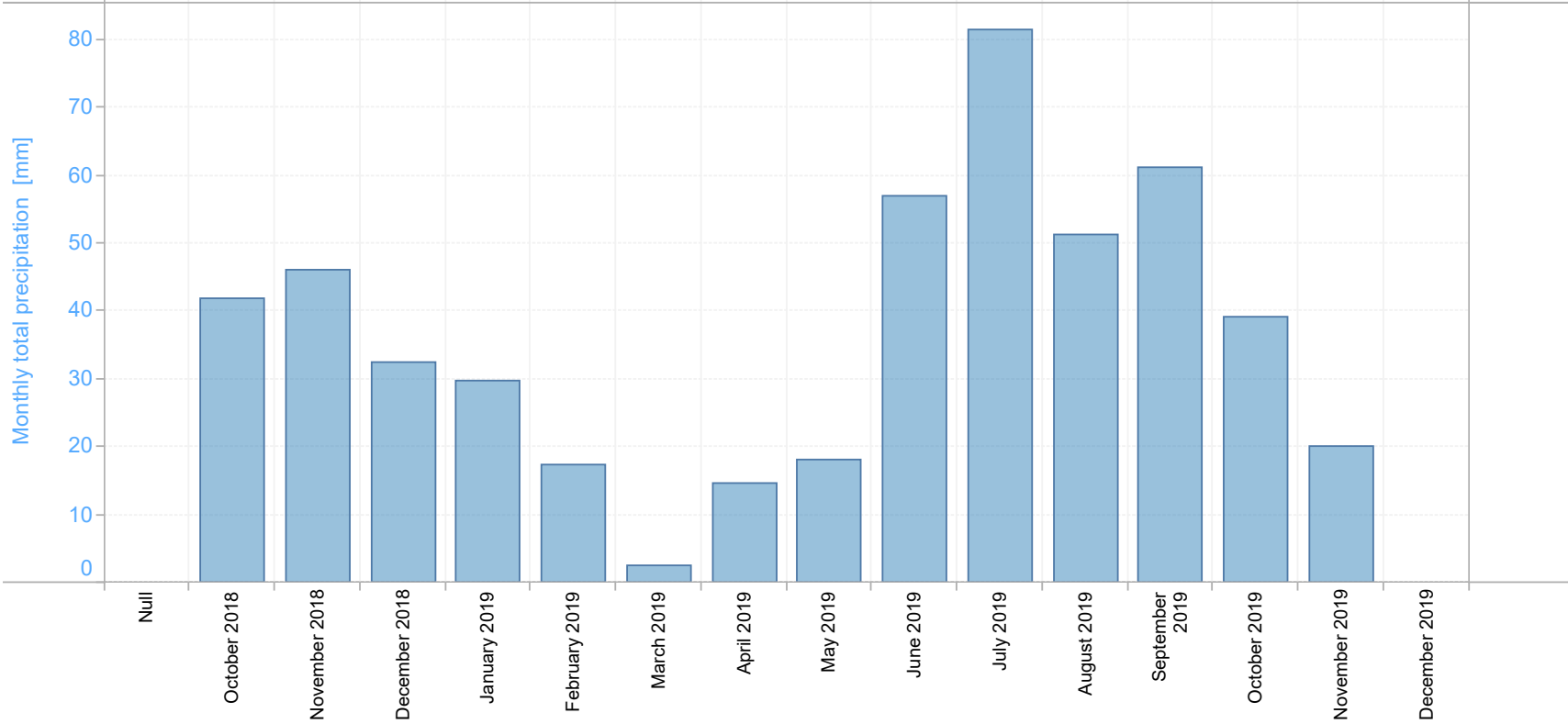
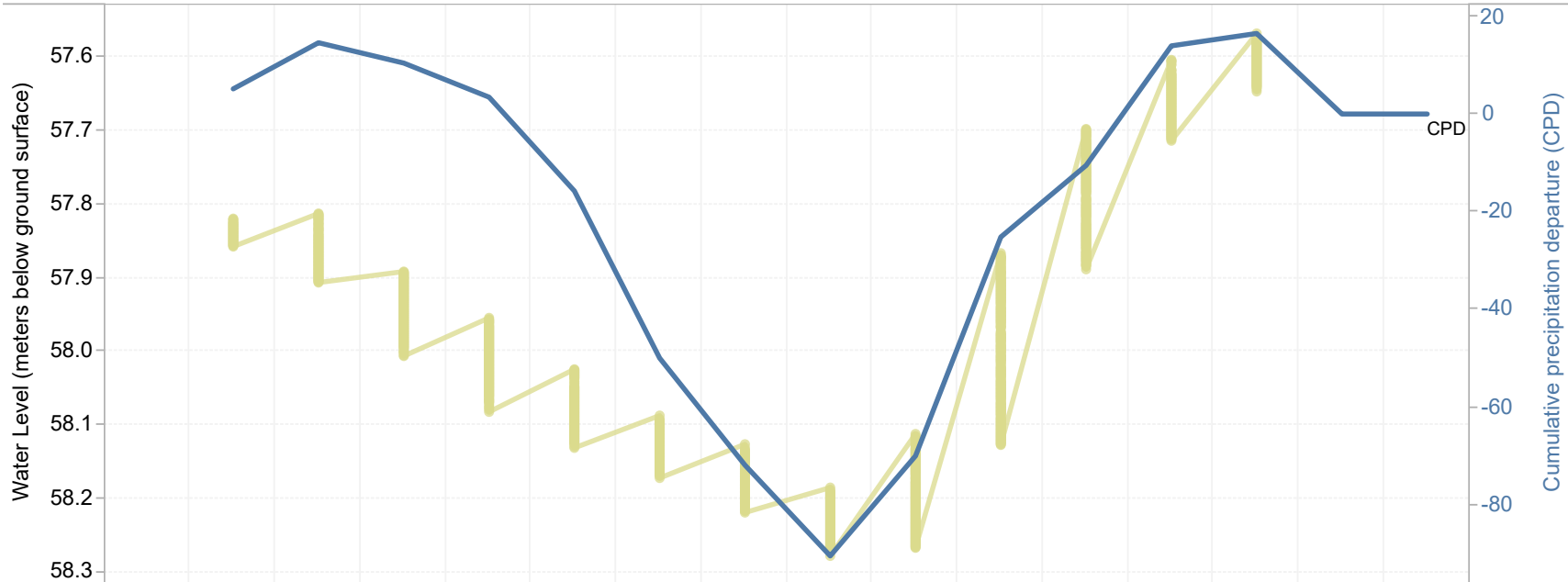

Graphs produced by:

C Waters
Consulting



Historical daily flow data for COLUMBIA RIVER AT ATHALMER & LLC_VOW_11 (All)

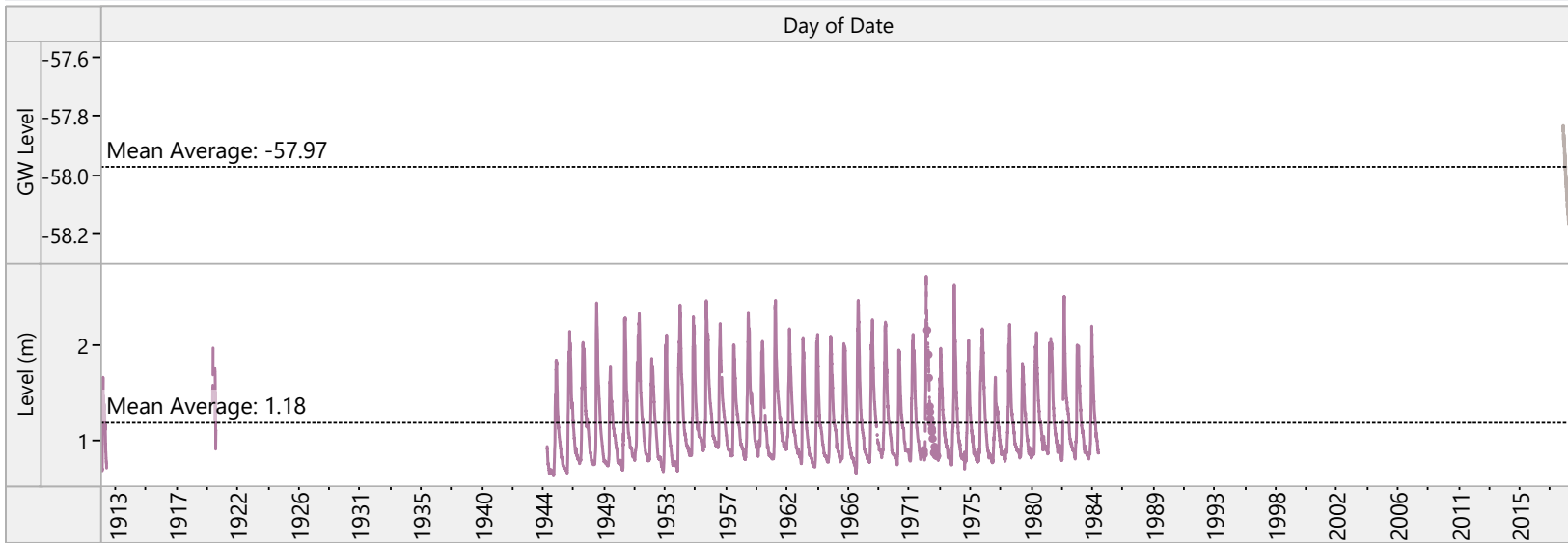

Parameter
Multiple values

Station Status
● ACTIVE
▼ DISCONTINUED

Station ID
■ 08NA004
■ LLC_VOW_11

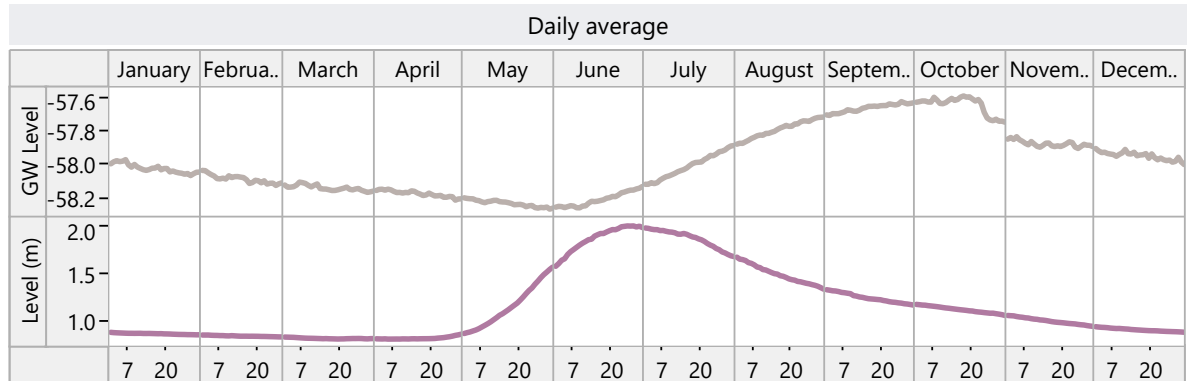
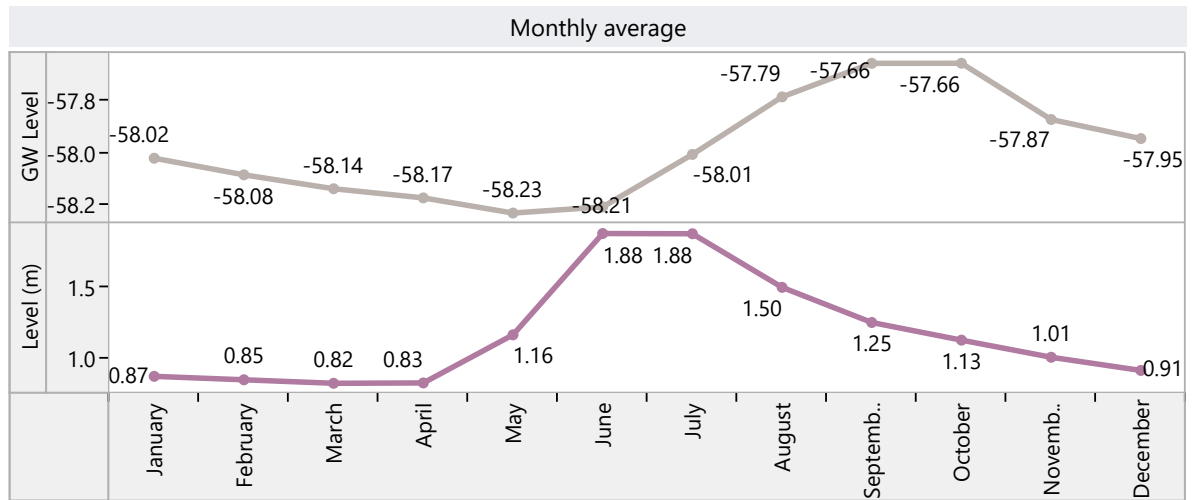
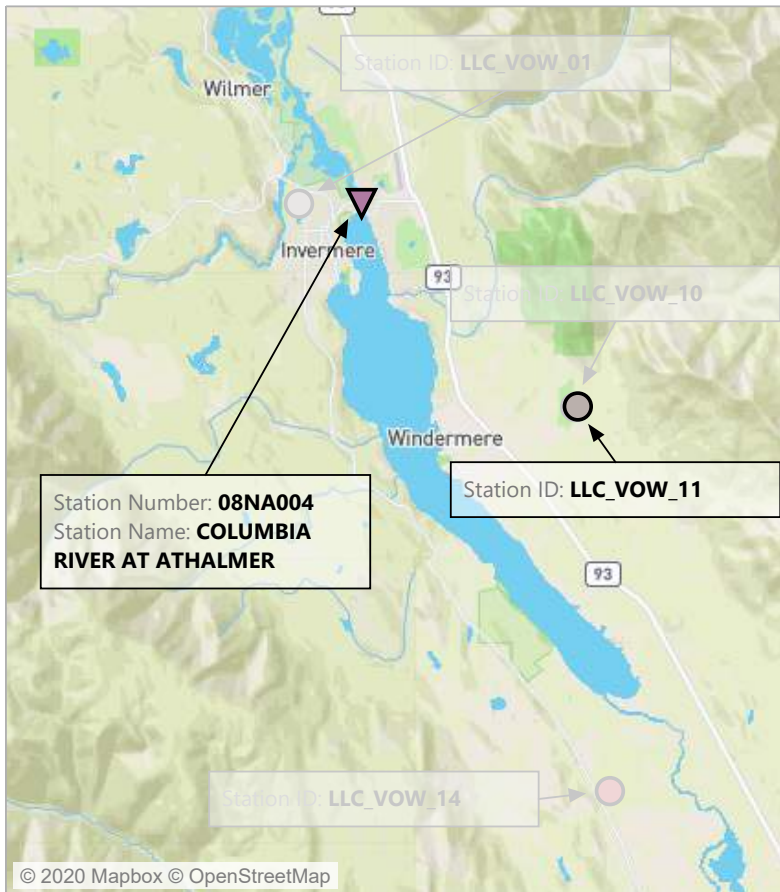

Monitoring Location: VOW_12 - Willow Point, Heddle Road.

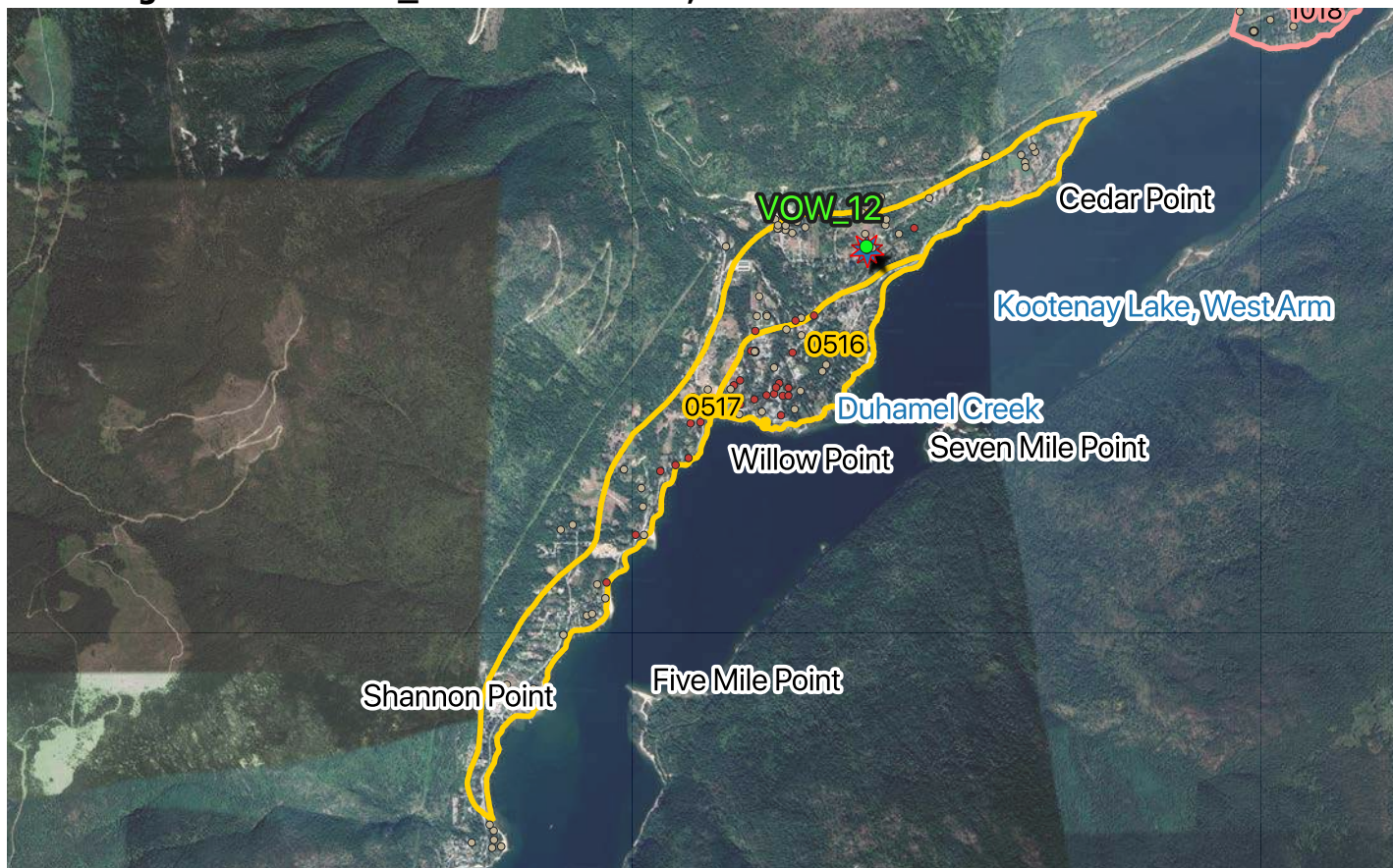

Legend

Living Lakes Canada

Volunteer Observation Well (VOW)

- Active

Provincially Mapped Aquifers

- Bedrock Aquifer
- Sand & Gravel Aquifer

Wells registered in GWELLS

- Well Decommissioned
- Well assigned to a Mapped Aquifer
- Well not assigned to a Mapped Aquifer

- ★ Locations Corrected

Environmental Monitoring System

Groundwater Sampling

- Spring or Hot Spring
- Well
- Monitoring Well
- Contaminated Site
- Observation Well

Data Sources

- BC Data Catalogue (Groundwater Aquifers, Jun 4 2019; GWELLS, May 9 2019; Environmental Monitoring System, May 29 2019; BC Geographical Names, Dec 13 2019)
- Pacific Climate Impacts Consortium (BC Station Data, Nov 29 2019)
- Google Satellite

Coordinate Reference System: WGS 84 / UTM Zone 11N (EPSG: 32611)

Well Station ID: LLC_VOW_12

Location Description: Willow Point, Heddle Road. North shore of the West Arm of Kootenay Lake.

Reason for monitoring: Adjacent to Aquifer 516 which is identified as a priority for monitoring in 2009 PGOWN Review and suggested by FLNRORD. LLC couldn't find well to monitor in Aquifer 516. Land owner volunteered this well.

Well Information

Well Tag Number:	107254	Well ID # from owner:	n/a
Well Plate ID:	37927		
Well Stick up (m):	0.33	EMS #	n/a
Well Depth (m):	83.2	Latitude:	49.58237
Well Casing:	6" Steel	Longitude:	-117.21922
		Source of Location	Handheld GPS
Top of Screen (mbgs):	No screen.	Coordinates:	
Bottom of Screen (mbgs):	No screen.		
Confining Layers:	None. Well record indicates all sand, gravel and cobbles.		
Initial Well Use/Reason for well construction:	Private domestic water supply well		

Monitoring Information

Monitoring Status:	Active
Monitoring Interval:	Hourly
Length of Monitoring Record:	2019-08-22 to Current
Data available on BC Real-time Water Data Website?	Yes
Water Level Sensor:	HOBO MX2001-02 (Range- 30m)
Data Logger Type:	HOBO MX 2001
Barometric Pressure Sensor:	HOBO MX2001- installed in airspace at top of well
Water Level Sensor Depth (mbgs):	80.9
Comments:	Further research needed to confirm if this well is in Aquifer 517. There is a hydrometric station upstream on Duhamel Creek. There are several points of diversion between the hydrometric station and Aquifer 517.

Nearest climate station with a complete record

Climate Network Name:	Environment Canada (Canadian Daily Climate Data)
Climate Station Location/Name:	GOLDEN A
Climate Station Number:	1364

Aquifer Information

Aquifer #:	May be in Aquifer 517. Further research needed to confirm.
Aquifer Material:	517- Sand and gravel
Aquifer Area (km²):	2.8
Aquifer Confinement:	517- Confined with localized windows.
Description¹:	517- Confined glacio-fluvial sand and gravel aquifers underneath till, in between till layers, or underlying glacio-lacustrine deposits (subtype = 4b).
Likelihood of hydraulic connection¹:	517- Not likely (based on broad regional assessment)
Hydraulic Connection Assessment by LLC²:	Not assessed.
Rational for Hydraulic Connection Assessment by LLC³:	Not assessed.

Foot Notes

¹From Provincial aquifer factsheets available at <https://apps.nrs.gov.bc.ca/gwells/aquifers>

²Assessed by Living Lakes Canada. See methods in report.

³Rational for hydraulic connectivity assessment by Living Lakes Canada.



GW SOLUTIONS
ASSESSMENT & PROTECTION OF GROUNDWATER



WELL ID:
LLC_VOW_12

EASTING: 484153
NORTHING: 5492221
DATE COMMENCED: 05 September, 2012
DATE COMPLETED: 06 September, 2012

LOCATION: Columbia Basin
CONTRACTOR: Owen's Drilling
STICK UP (m): 0.33

WELL ID PLATE No.: 37927
BC WELL TAG No.: 107254
DRILL RIG: Air Rotary
DRILLER: Stan Woodford
LOGGED BY: Driller

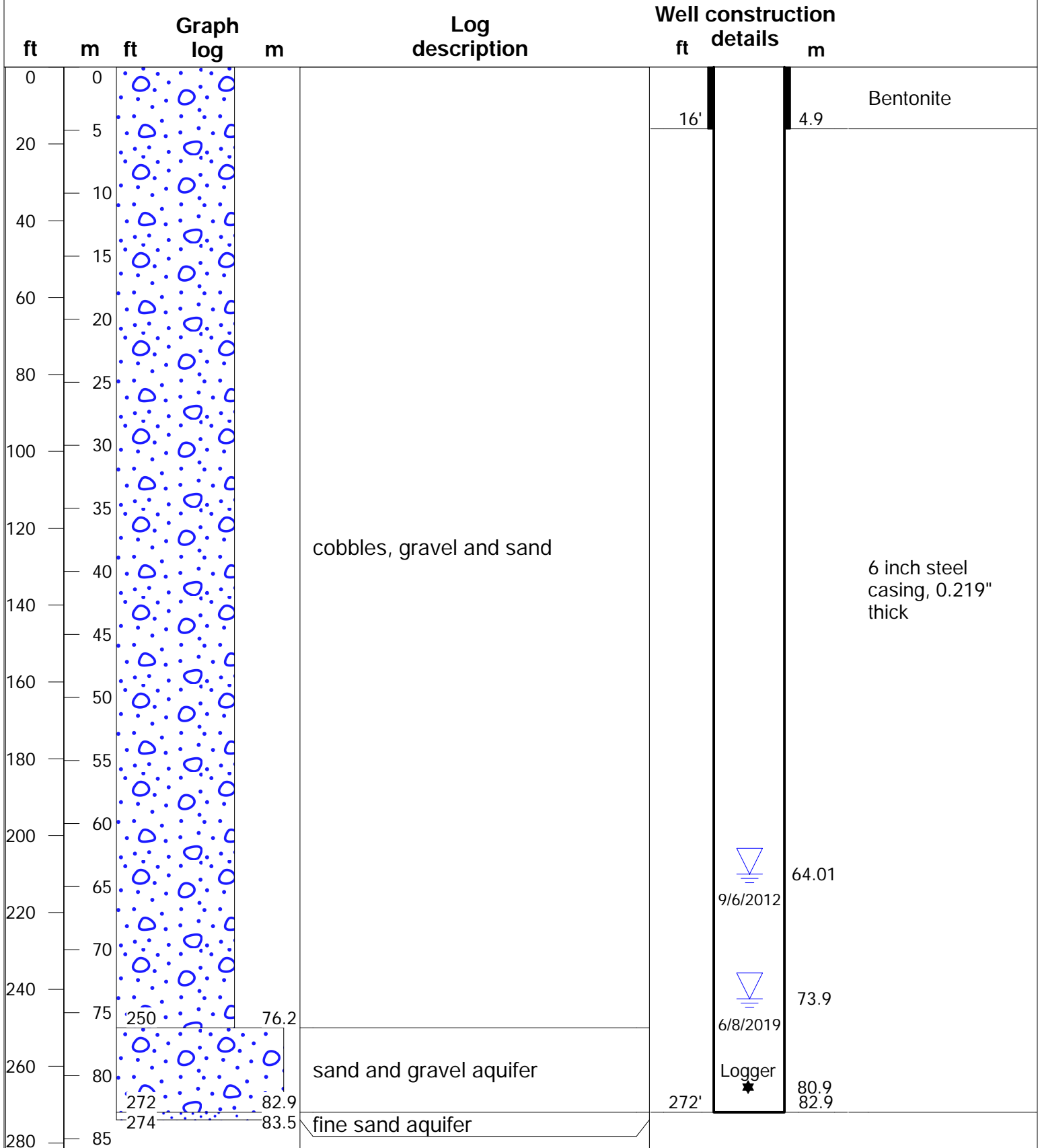

Water Level & Water Temperature Station ID: LLC_VOW_12

Station ID
LLC_VOW_12

Measurement Type

- Manual data
- Logger data

Water Level (meters below ground surface)

73.6
73.7
73.8
73.9
74.0
74.1

Well depth (mbgs)

83.2

Depth of Water Level
Sensor (mbgs)

80.9 mbgs

Water Temperature (°C)

8.48
8.46
8.44
8.42
8.40



Graphs produced by:

C Waters
Consulting



GW SOLUTIONS
ASSESSMENT & PROTECTION OF GROUNDWATER

Jun 1, 19 Jul 1, 19 Aug 1, 19 Sep 1, 19 Oct 1, 19 Nov 1, 19 Dec 1, 19 Jan 1, 20

Date

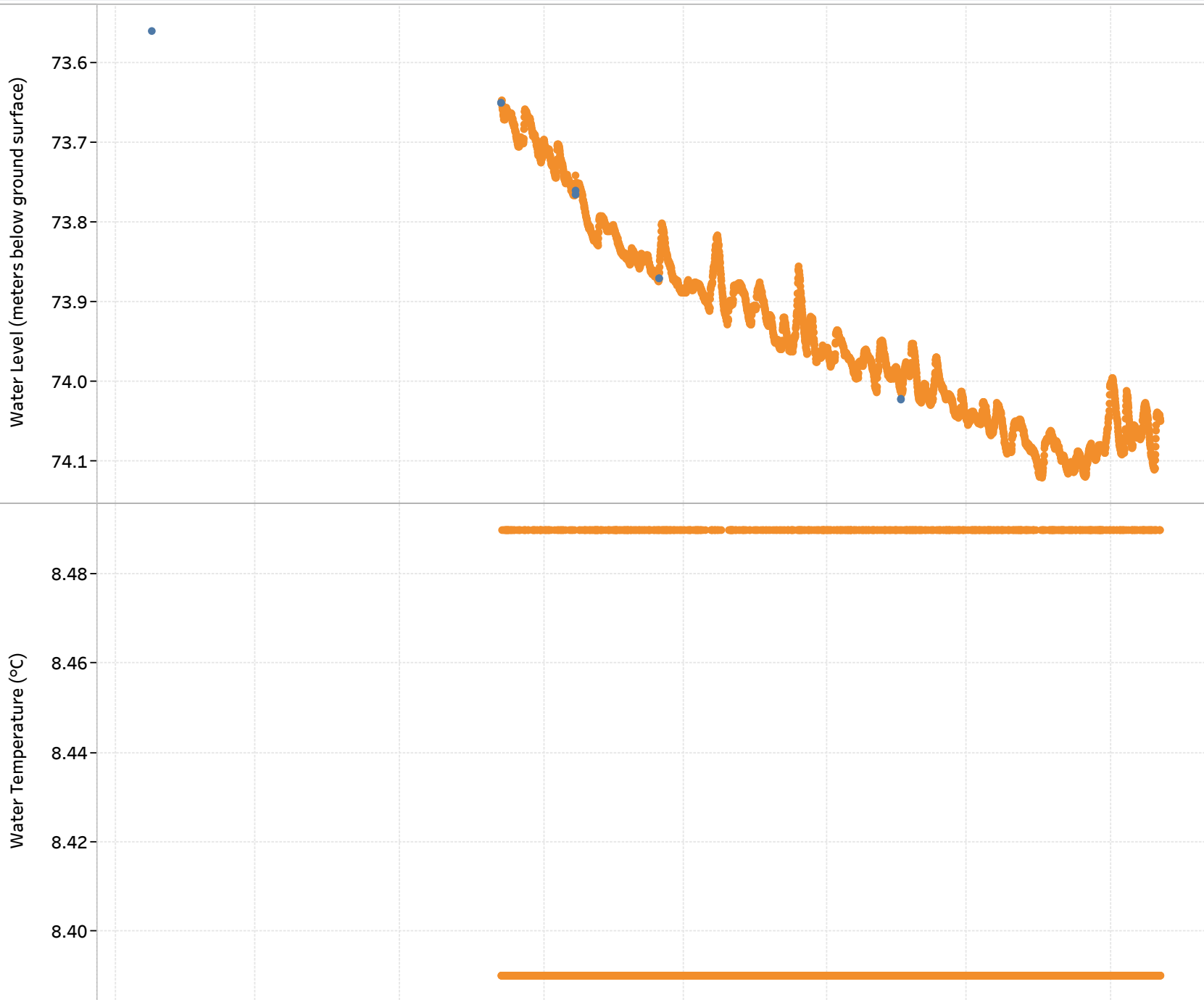

Water Level & Daily Total Precipitation
Station ID: LLC_VOW_12

Station ID Groundwater
LLC_VOW_12

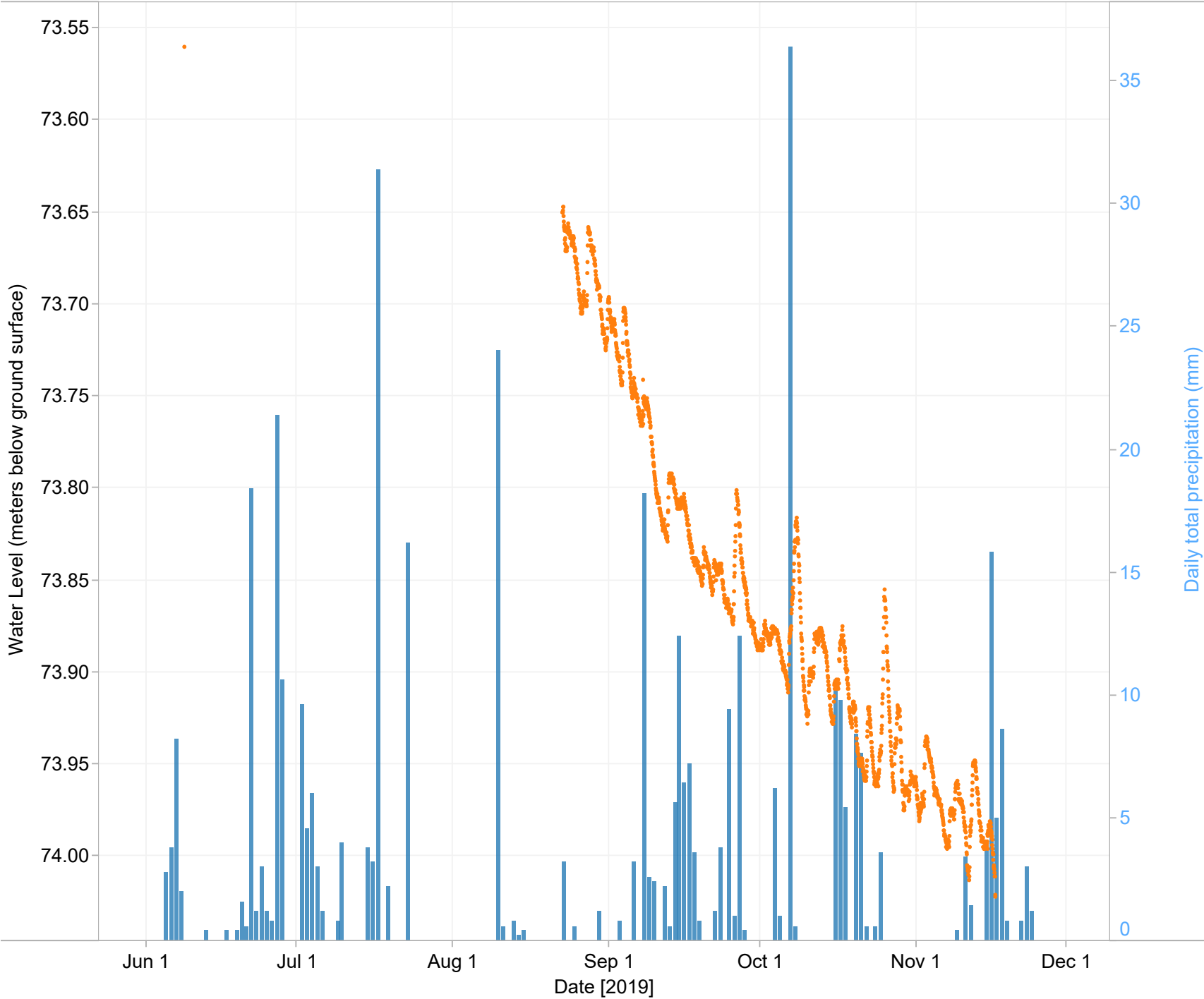

Station ID Legend

- 1095
- LLC_VOW_12

Precipitation	1095	NELSON RIXEN CREEK
Groundwater	LLC_VOW_12	Willow Point, Heddle Road. North shore of the West Arm of Kootenay Lake.



Graphs produced by:

C Waters
Consulting



GW SOLUTIONS
ASSESSMENT & PROTECTION OF GROUNDWATER

Historical daily flow data for DUHAMEL CREEK ABOVE DIVERSIONS & LLC_VOW_12 (All)

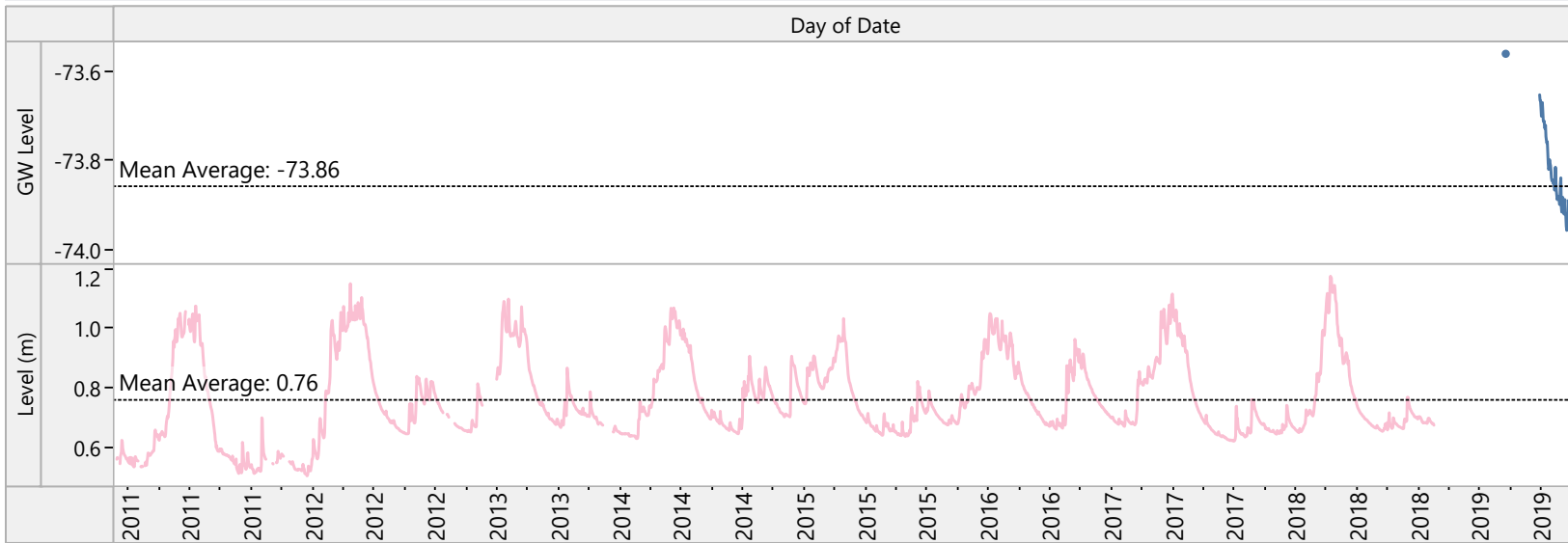

Parameter
Multiple values

Station Status
● ACTIVE
▼ DISCONTINUED

Station ID
■ 08NJ026
■ LLC_VOW_12

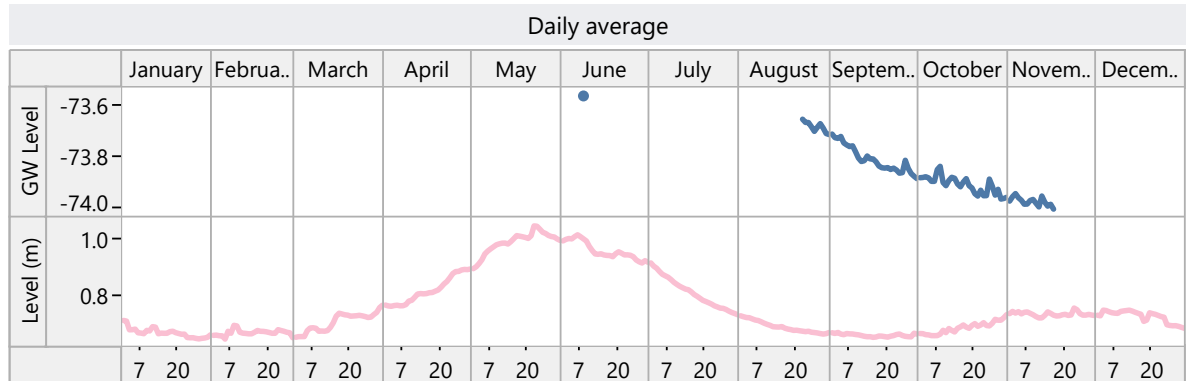
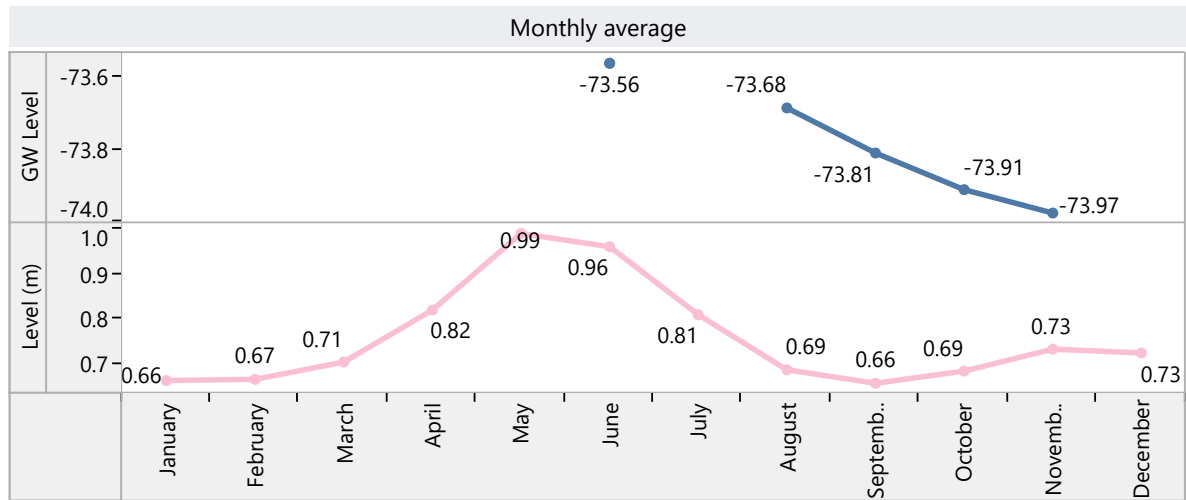
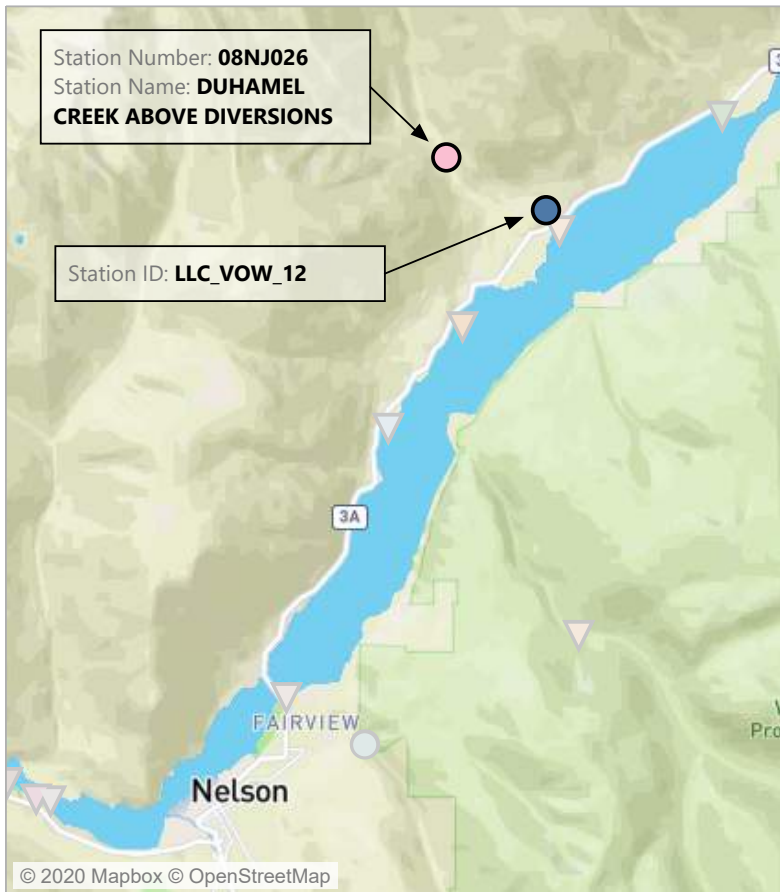

Historical daily flow data for KOOTENAY RIVER AT NELSON & LLC_VOW_12 (All)

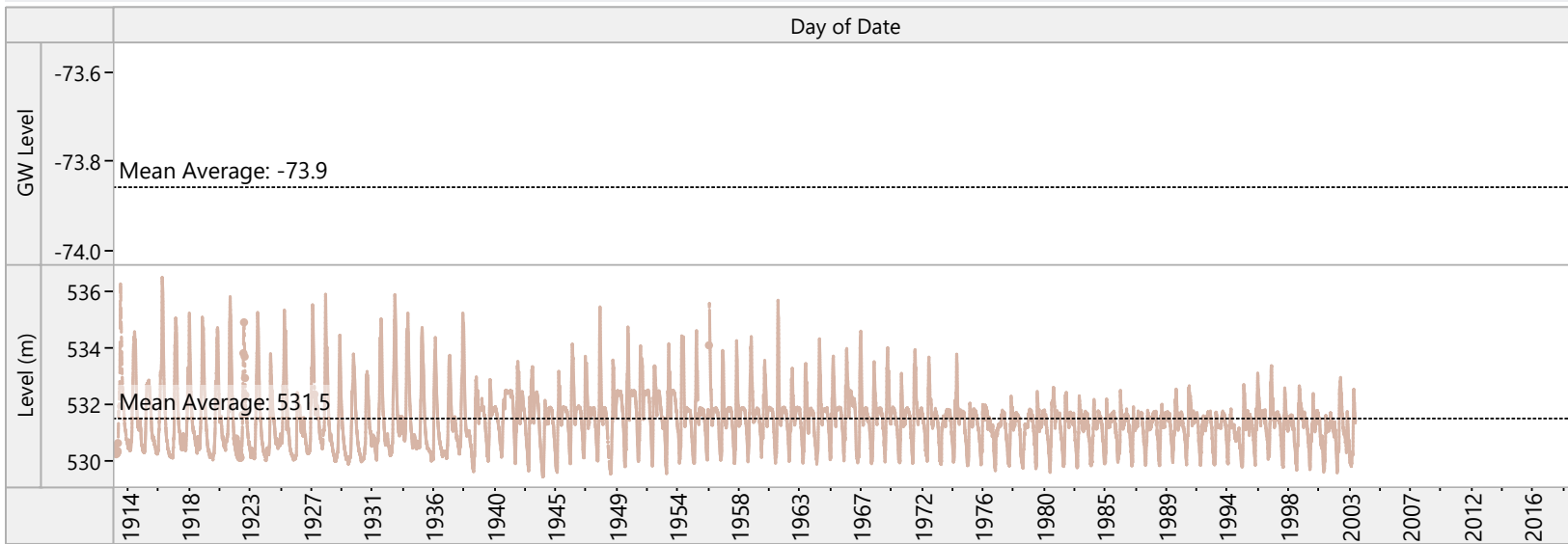

Parameter
Multiple values

Station Status
● ACTIVE
▼ DISCONTINUED

Station ID
08NJ009
LLC_VOW_12

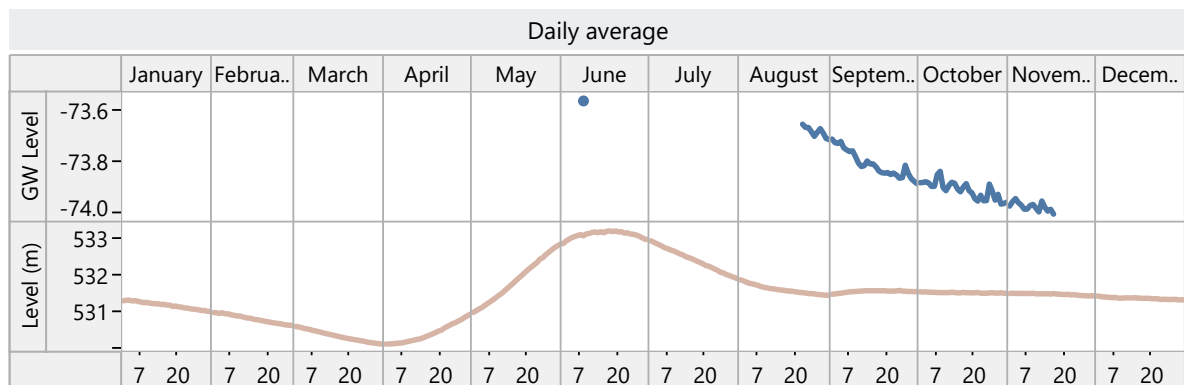
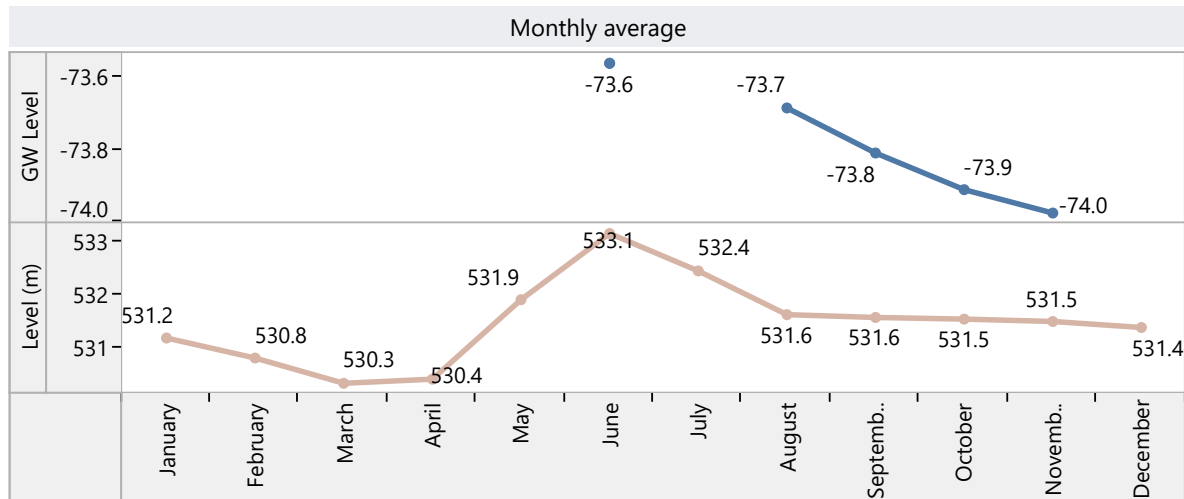
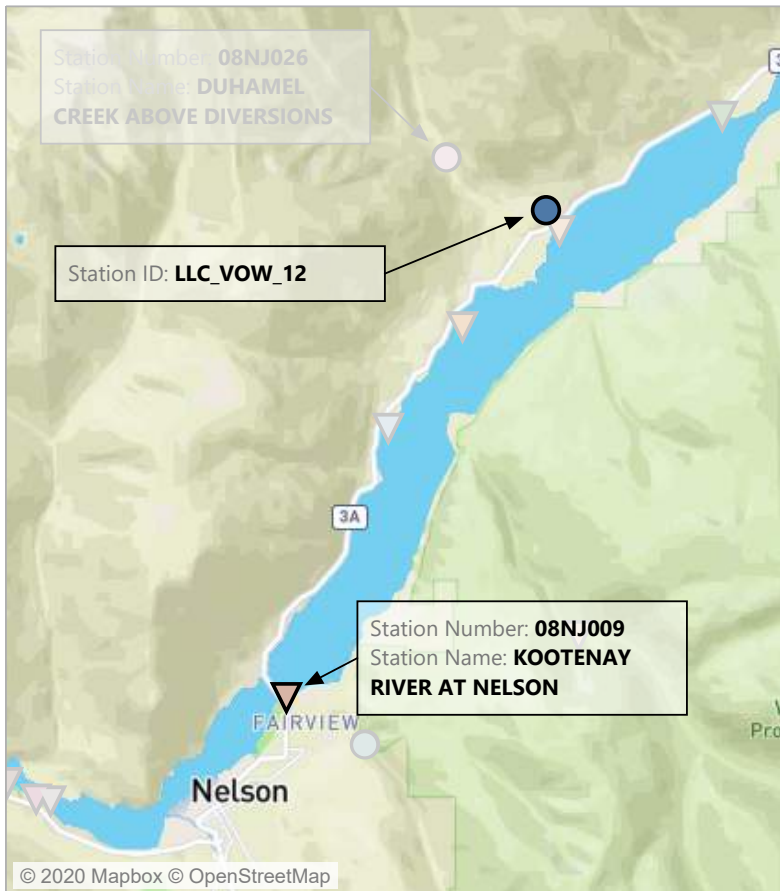

Monitoring Location: VOW_13 - Brisco, Sylvania Road.

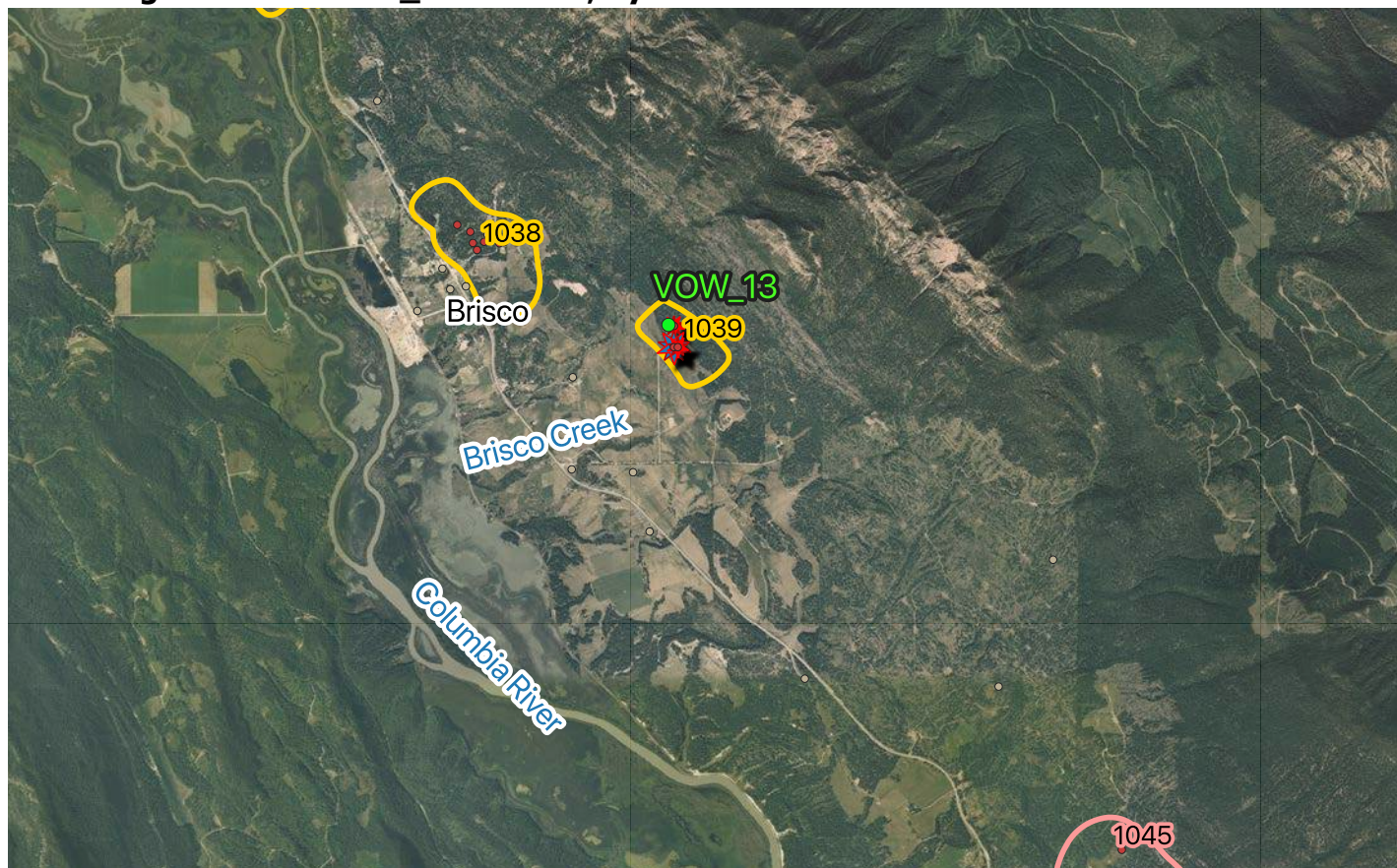

Legend

Living Lakes Canada

Volunteer Observation Well (VOW)

- Active

Provincially Mapped Aquifers

- Bedrock Aquifer
- Sand & Gravel Aquifer

Wells registered in GWELLS

- Well Decommissioned
- Well assigned to a Mapped Aquifer
- Well not assigned to a Mapped Aquifer
- ★ Known incorrect well location or other error
- ★ Locations Corrected

Environmental Monitoring System

Groundwater Sampling

- Spring or Hot Spring
- Well
- Monitoring Well
- Contaminated Site
- Observation Well

Data Sources

- BC Data Catalogue (Groundwater Aquifers, Jun 4 2019; GWELLS, May 9 2019; Environmental Monitoring System, May 29 2019; BC Geographical Names, Dec 13 2019)
- Pacific Climate Impacts Consortium (BC Station Data, Nov 29 2019)
- Google Satellite

Coordinate Reference System: WGS 84 / UTM Zone 11N (EPSG: 32611)

Well Station ID: LLC_VOW_13

Location Description: Brisco, Sylvania Road. East side of Columbia Wetlands

Reason for monitoring: Monitoring of groundwater along the benches of the Columbia Wetlands (above the valley bottoms).

Well Information

Well Tag Number:	101596	Well ID # from owner:	n/a
Well Plate ID:	None		
Well Stick up (m):	0.203	EMS #	n/a
Well Depth (m):	22.4	Latitude:	50.824341
Well Casing:	6" Steel	Longitude:	-116.247615
		Source of Location	
Top of Screen (mbgs):	No screen.	Coordinates:	
Bottom of Screen (mbgs):	No screen.		Handheld GPS
Confining Layers:	Mixes of gravels, clays, and sands 0 to 23.2 m.		
Initial Well Use/Reason for well construction:	Private domestic water supply well		

Monitoring Information

Monitoring Status: Active

Monitoring Interval: Hourly

Length of Monitoring Record: 2019-09-17 to Current

Data available on BC Real-time Water Data Website? Yes

Water Level Sensor: HOBO MX2001-02 (Range- 9m)

Data Logger Type: HOBO MX 2001

Barometric Pressure Sensor: HOBO MX2001- installed in airspace at top of well

Water Level Sensor Depth (mbgs): 15

Comments: Well locations in this area in GWELLS are inaccurate. WTN101601 has been decommissioned. WTN95580 is used as water supply for a domestic garden. House on the property uses Brandon Spring as a water supply. From Oct 10/11 2019 to November 5th, the house on the property used WTN95580 as a water supply instead of Brandon Spring. For comparison to precipitation data, should check Ministry of Transport and Infrastructure and Ministry of Forests, Lands, and Natural Resources Operations and Rural Development Climate Station data that may be more representative of local conditions.

Nearest climate station with a complete record

Climate Network Name: Environment Canada (Canadian Daily Climate Data)

Climate Station Location/Name: GOLDEN A

Climate Station Number: 1364

Aquifer Information

Aquifer #:	1039
Aquifer Material:	Sand and gravel
Aquifer Area (km²):	0.25 (The Aquifer Mapping Report states that "the aquifer boundary has been delineated using spatially limited water well record information, topography, drainage features, area of development, landforms and soils information. The aquifer may extend further towards the northwest and southeast along the Columbia River Valley.")
Aquifer Confinement:	Confined
Description¹:	Confined glacio-fluvial sand and gravel aquifers underneath till, in between till layers, or underlying glacio-lacustrine deposits (subtype = 4b).
Likelihood of hydraulic connection¹:	Not likely (based on broad regional assessment)
Hydraulic Connection Assessment by LLC²:	Not assessed.
Rational for Hydraulic Connection Assessment by LLC³:	Not assessed.

Foot Notes

¹From Provincial aquifer factsheets available at <https://apps.nrs.gov.bc.ca/gwells/aquifers>

²Assessed by Living Lakes Canada. See methods in report.

³Rational for hydraulic connectivity assessment by Living Lakes Canada.



GW SOLUTIONS
ASSESSMENT & PROTECTION OF GROUNDWATER



WELL ID:
LLC_VOW_13

EASTING: 552993
NORTHING: 5630561
DATE COMMENCED: 10 October, 2001
DATE COMPLETED: 10 October, 2001

LOCATION: Columbia Basin
CONTRACTOR: Owen's Drilling
STICK UP (m): 0.20

WELL ID PLATE No.: None
BC WELL TAG No.: 101596
DRILL RIG: Air rotary
DRILLER: Harry Caldwell
LOGGED BY: Driller

Graph log		Log description	Well construction details	
ft	m		ft	m
0	0	clay gravel		
4				
8		sand		
12				
14	4.3	blue clay silty		
16				
20	6.7	silty clay - wet		
24				
28		gravel clay		
32				
36		gravel clay sand		
40				
44		brown clay		
48				
52	15.0			
54	16.5			
56				
60				
64				
66	20.1			
68	21			
72	22.4			
76	23.2			

No construction details

★
Logger

Water Level & Water Temperature Station ID: LLC_VOW_13

Station ID
LLC_VOW_13

Measurement Type

- Manual data
- Logger data

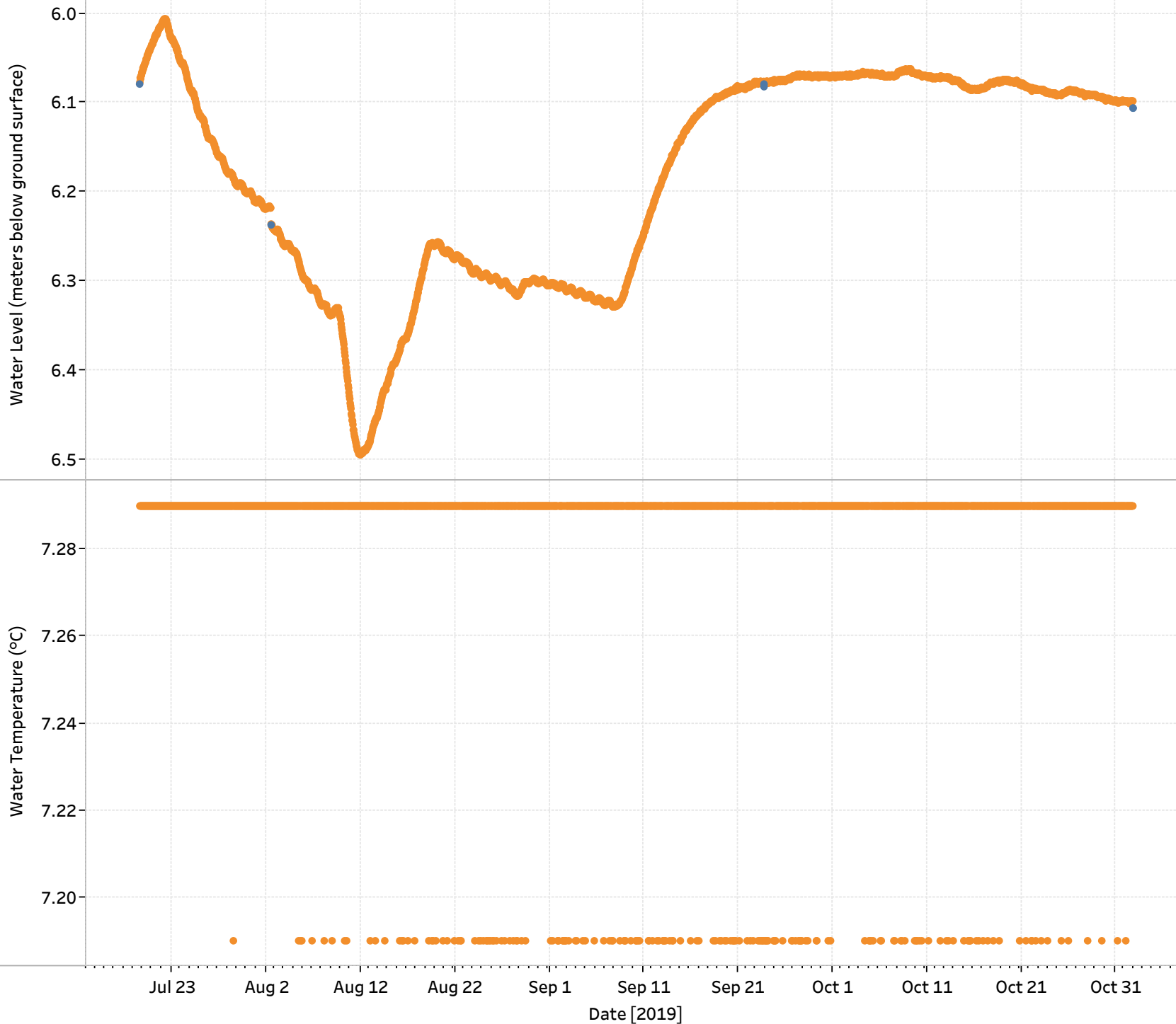

Well depth (mbgs)

22.4

Depth of Water Level Sensor (mbgs)

15 mbgs



Graphs produced by:

C Waters Consulting



GW SOLUTIONS
ASSESSMENT & PROTECTION OF GROUNDWATER

Water Level & Daily Total Precipitation
Station ID: LLC_VOW_13

Station ID Groundwater
LLC_VOW_13

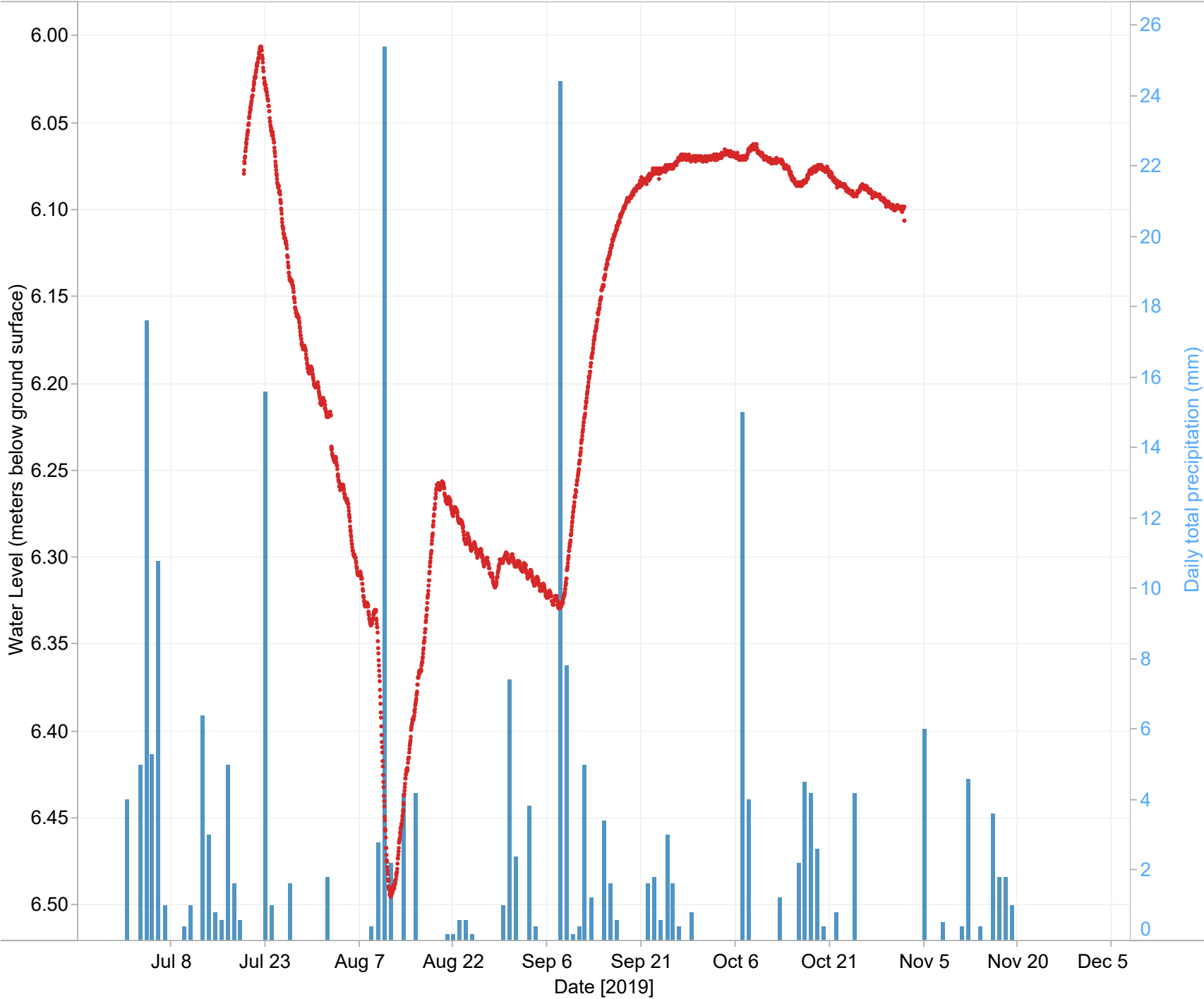

Station ID Legend
■ 1364
■ LLC_VOW_13

Precipitation	1364	GOLDEN A
Groundwater	LLC_VOW_13	Brisco, Sylvania Road. East side of Columbia Wetlands



Graphs produced by:

C Waters
Consulting



GW SOLUTIONS
ASSESSMENT & PROTECTION OF GROUNDWATER

Historical daily flow data for LLC_VOW_13 & SPILLIMACHEEN RIVER NEAR SPILLIMACHEEN (All)

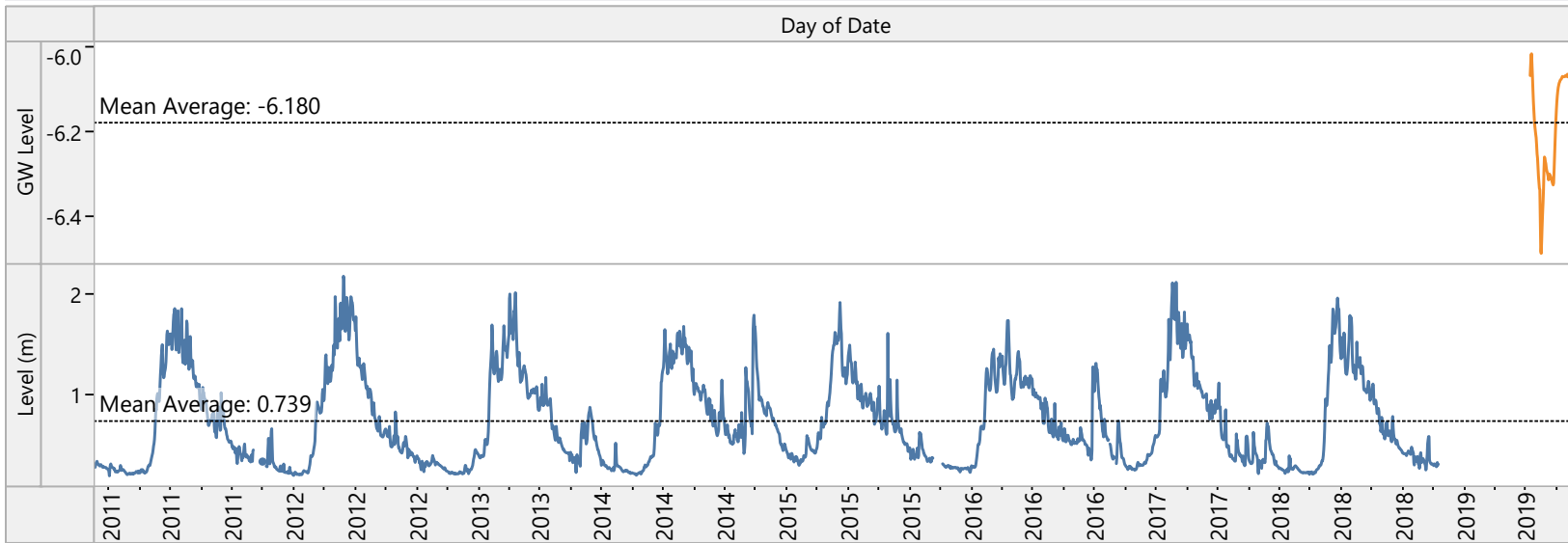

Parameter
Multiple values

Station Status
● ACTIVE
▼ DISCONTINUED

Station ID
■ 08NA011
■ LLC_VOW_13

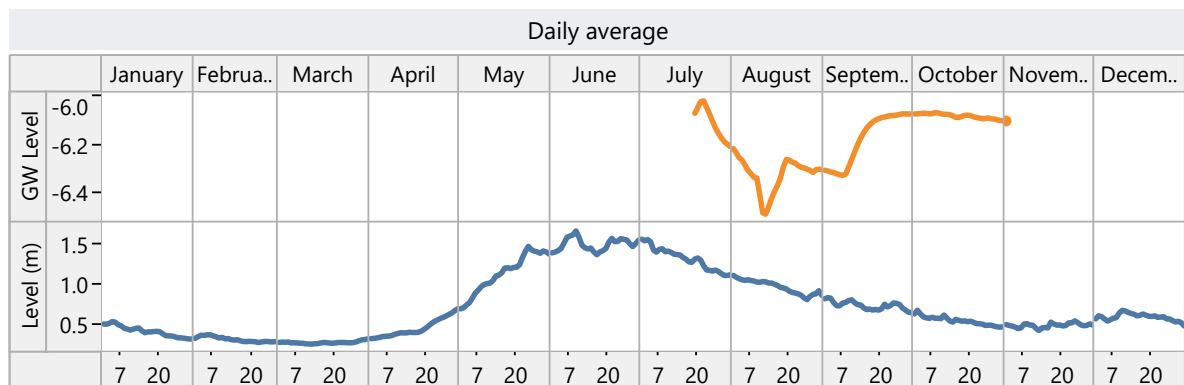
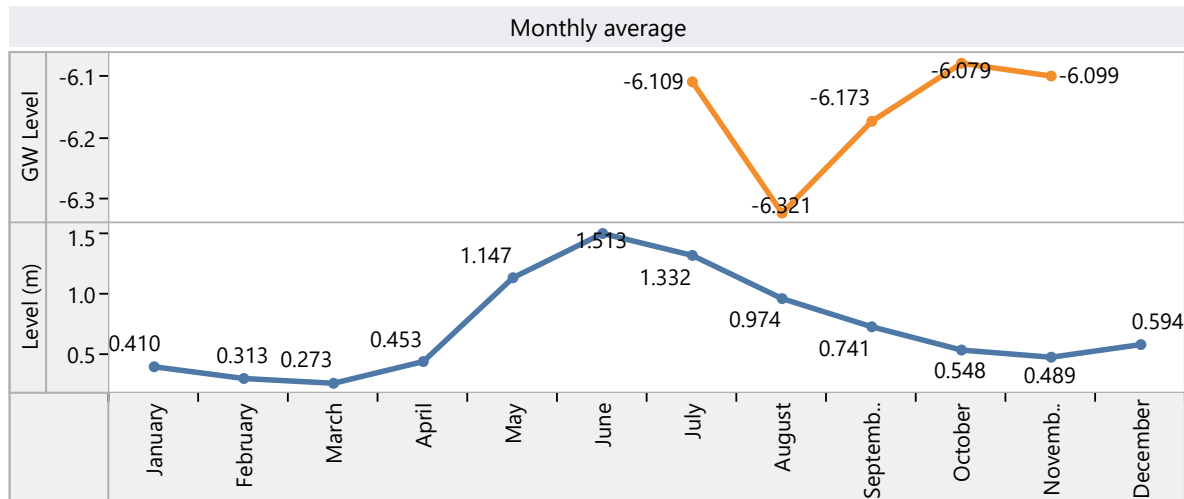
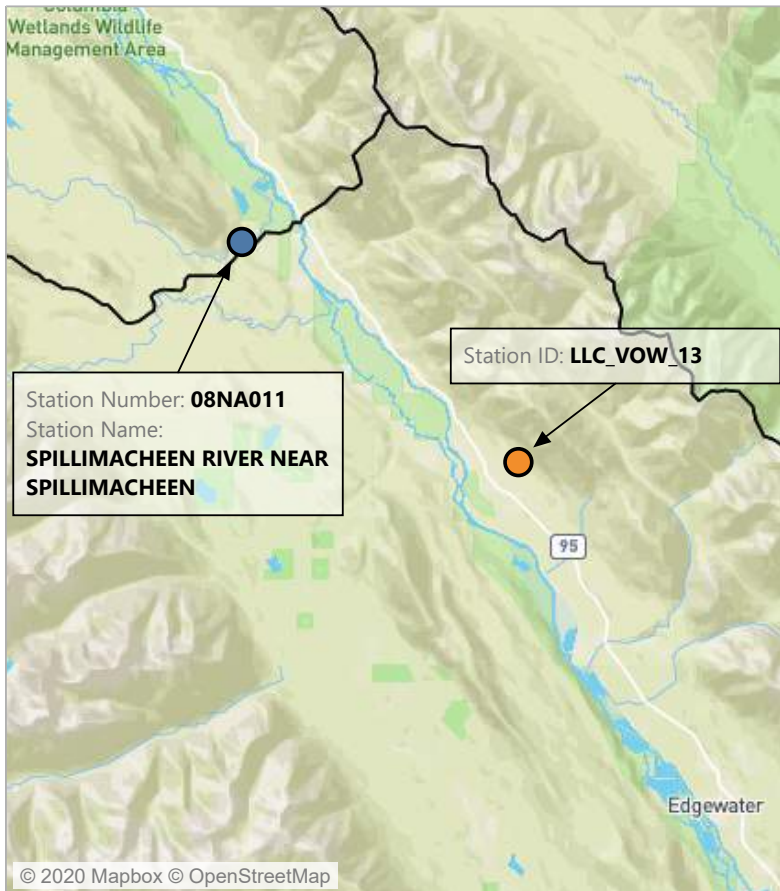

Monitoring Location: VOW_14 - North of Fairmont, Westside Road.

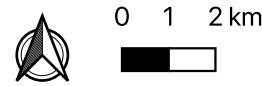
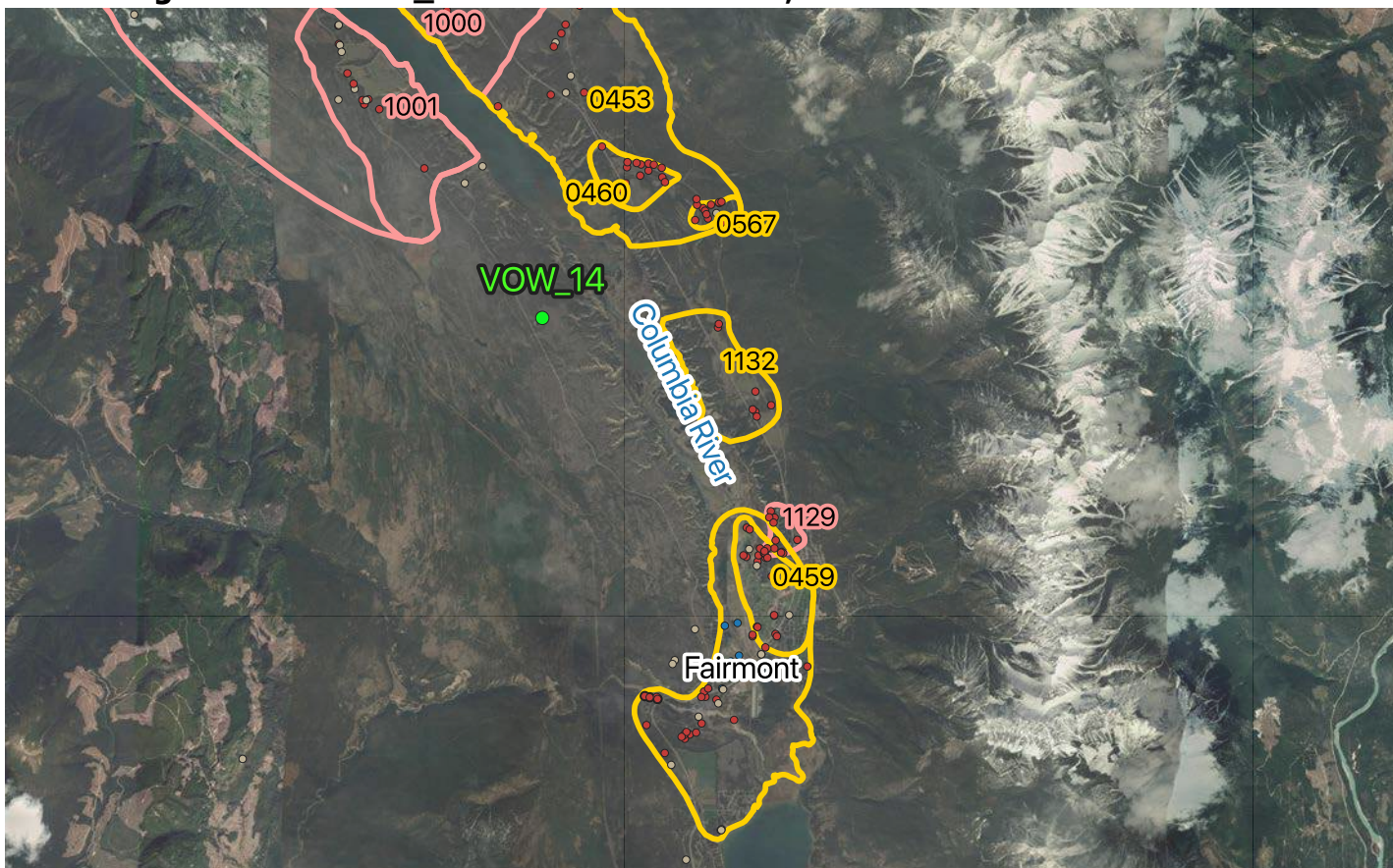

Legend

**Living Lakes Canada
Volunteer Observation Well (VOW)**

- Active

Provincially Mapped Aquifers

- Bedrock Aquifer
- Sand & Gravel Aquifer

Wells registered in GWELLS

- Well Decommissioned
- Well assigned to a Mapped Aquifer
- Well not assigned to a Mapped Aquifer

**Environmental Monitoring System
Groundwater Sampling**

- Spring or Hot Spring
- Well
- Monitoring Well
- Contaminated Site
- Observation Well

Data Sources

-BC Data Catalogue (Groundwater Aquifers, Jun 4 2019; GWELLS, May 9 2019; Environmental Monitoring System, May 29 2019; BC Geographical Names, Dec 13 2019)
 -Google Satellite

Coordinate Reference System: WGS 84 / UTM Zone 11N (EPSG: 32611)

Well Station ID: LLC_VOW_14

Location Description: North of Fairmont, West of Columbia Wetlands, Westside Road.

Reason for monitoring: Suitable well on west benches of Columbia Wetlands.

Well Information

Well Tag Number:	103641	Well ID # from owner:	n/a
Well Plate ID:	28716		
Well Stick up (m):	0.3	EMS #	n/a
Well Depth (m):	55.5	Latitude:	50.386431
Well Casing:	6" Steel	Longitude:	-115.933384
		Source of Location	GWELLS Database
Top of Screen (mbgs):	54.86	Coordinates:	(Handheld GPS)
Bottom of Screen (mbgs):	55.47		
Confining Layers:	Clay (0 to 29 mbgs)		
Initial Well Use/Reason for well construction:	Water supply well for wetland restoration/construction. Pump has been removed. Well will likely no longer be needed to supply water to the wetland.		

Monitoring Information

Monitoring Status:	Active
Monitoring Interval:	Hourly
Length of Monitoring Record:	2020-01-06 to Current
Data available on BC Real-time Water Data Website?	Yes
Water Level Sensor:	HOBO MX2001-04 (Range- 4 m)
Data Logger Type:	HOBO MX 2001
Barometric Pressure Sensor:	HOBO MX2001- installed in airspace at top of well
Water Level Sensor Depth (mbgs):	31

Comments: Likely very little future development around this well. Well is on The Nature Trust of BC's Hoodoos Conservation Property. Well was drilled to supply water to a restored wetland. Restored wetland has an impermeable liner. Pump has been removed from well and well will not likely be used again in the future. For comparison to precipitation data, should check Ministry of Transport and Infrastructure and Ministry of Forests, Lands, and Natural Resources Operations and Rural Development Climate Station data that may be more representative of local conditions.

Nearest climate station with a complete record

Climate Network Name:	Environment Canada (Canadian Daily Climate Data)
Climate Station Location/Name:	GOLDEN A
Climate Station Number:	1364

Aquifer Information

Aquifer #: No mapped aquifer in this area.
Aquifer Material: n/a
Aquifer Area (km²): n/a
Aquifer Confinement: n/a

Description¹: n/a

Likelihood of hydraulic connection¹: n/a

Hydraulic Connection Assessment by Not assessed.
LLC²:

Rational for Hydraulic Connection Not assessed.

Assessment by LLC³:

Foot Notes

¹From Provincial aquifer factsheets available at <https://apps.nrs.gov.bc.ca/gwells/aquifers>

²Assessed by Living Lakes Canada. See methods in report.

³Rational for hydraulic connectivity assessment by Living Lakes Canada.



GW SOLUTIONS
ASSESSMENT & PROTECTION OF GROUNDWATER



WELL ID:
LLC_VOW_14

EASTING: 575826

NORTHING: 5582141

DATE COMMENCED: 15 June, 2010

DATE COMPLETED: 18 June, 2010

LOCATION: Hoodoos Conservation Property

CONTRACTOR: Owen's Drilling

STICK UP (m): 0.30

WELL ID PLATE No.: 28716

BC WELL TAG No.: 103641

DRILL RIG: Air rotary

DRILLER: Mike Caldwell

LOGGED BY: Driller

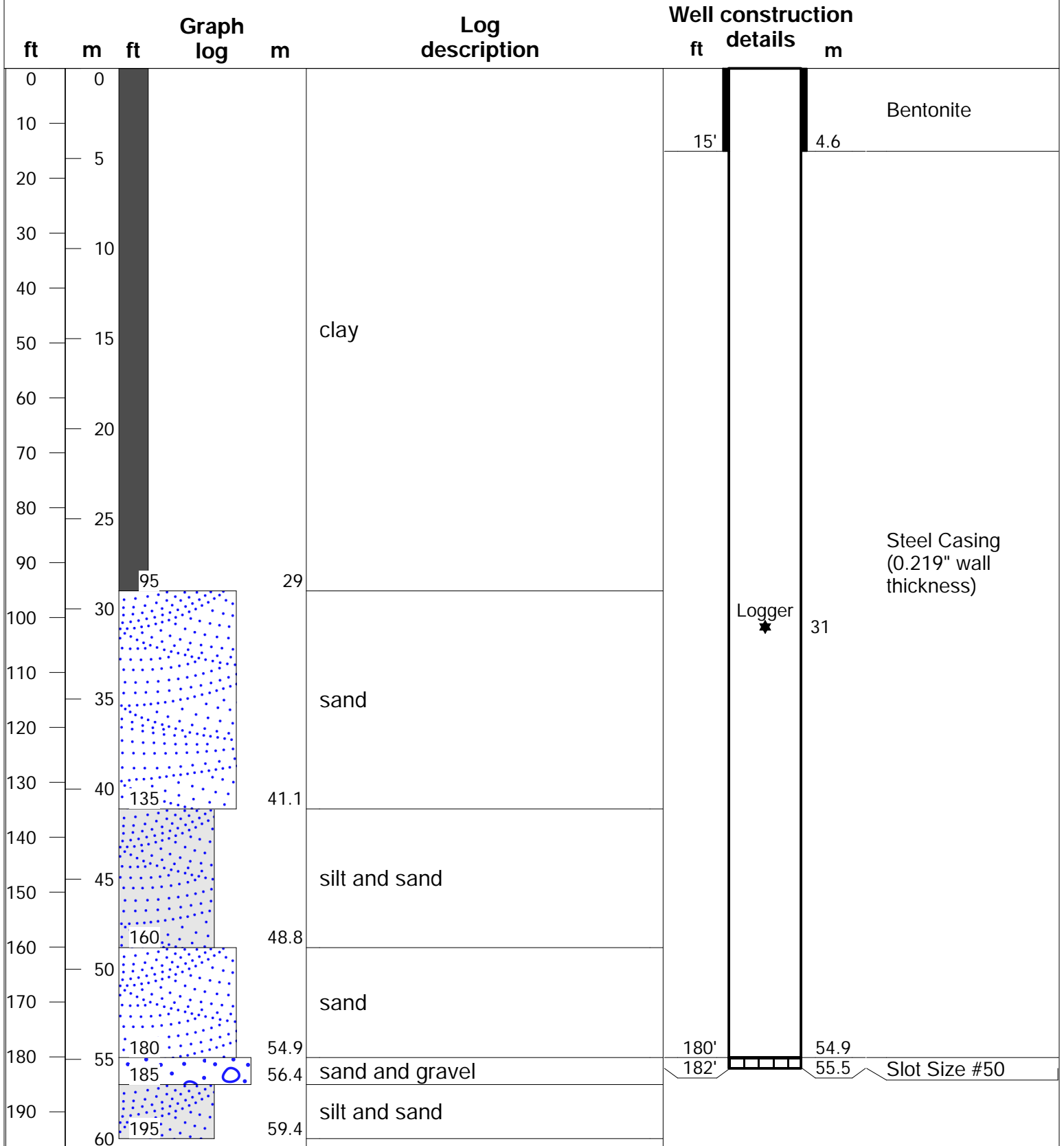

Water Level & Water Temperature Station ID: LLC_VOW_14

Station ID
LLC_VOW_14

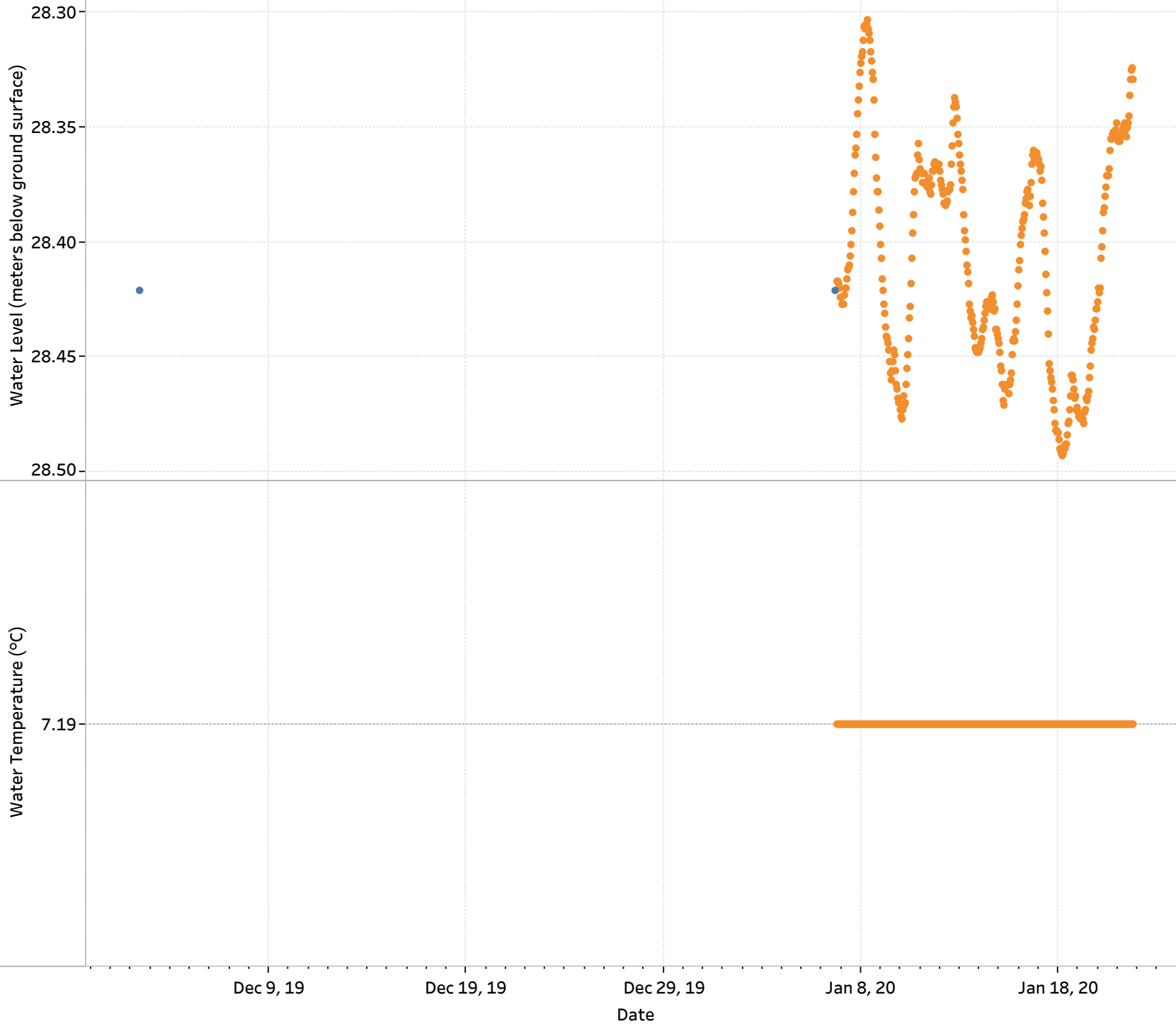

Measurement Type

- Manual data
- Logger data

Well depth (mbgs)

55.5

Depth of Water Level Sensor (mbgs)

31 mbgs



Graphs produced by:

C Waters Consulting



GW SOLUTIONS
ASSESSMENT & PROTECTION OF GROUNDWATER